

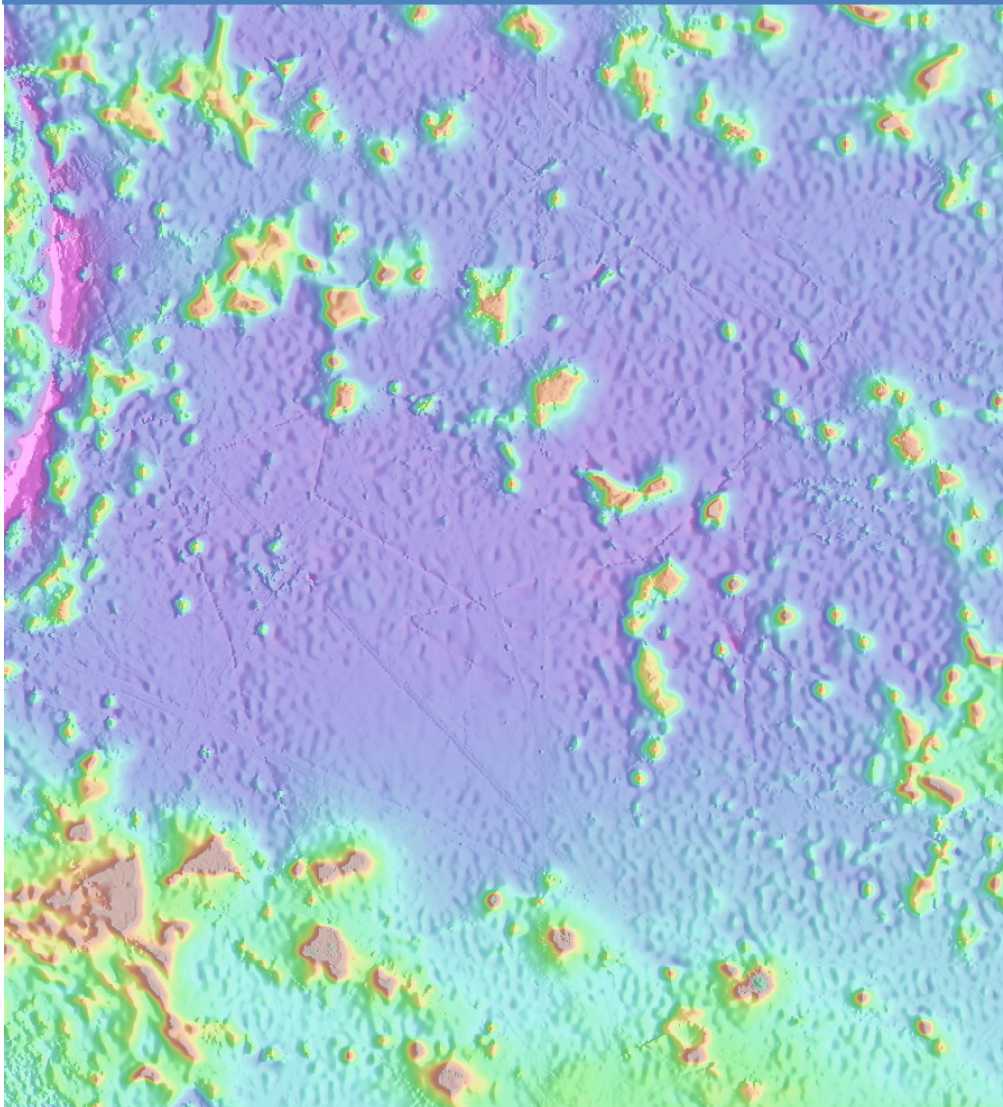

The IHO-IOC GEBCO Cook Book



October 2019

**IHO Publication B-11
IOC Manuals and Guides, 63**

Contributors



Directorate of Hydrography and Navigation (DHN)
Brazilian Navy, Brazil
<http://www.marinha.mil.br/dhn/>



**British Oceanographic
Data Centre**

NATURAL ENVIRONMENT RESEARCH COUNCIL

British Oceanographic Data Centre (BODC), UK
<http://www.bodc.ac.uk>



Canadian Hydrographic Service, Canada
<http://www.charts.gc.ca>



CARIS Geospatial Software Solutions, Canada
<http://www.caris.com>

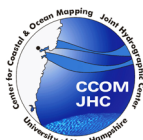

Center for Coastal & Ocean Mapping
Joint Hydrographic Center
University of New Hampshire, USA
<http://ccom.unh.edu>



Centro de Investigaciones Oceanográficas e Hidrográficas (CIOH),
Colombia
<http://www.cioh.org.co/>



Cooperative Institute for Research in Environmental Sciences (CIRES)
University of Colorado at Boulder
<http://cires.colorado.edu>



International Hydrographic Organization, Monaco
<http://www.iho.int>



Geological Survey of Israel, Israel
<http://www.gsi.gov.il>



**National
Oceanography Centre**
NATURAL ENVIRONMENT RESEARCH COUNCIL

National Oceanography Centre, UK
<http://noc.ac.uk/>



Naval Research Laboratory, USA
<http://www.nrl.navy.mil>



Nigerian Navy Hydrographic Office
Lagos, Nigeria
<http://www.nnho.ng/>

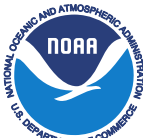

NOAA Laboratory for Satellite Altimetry, USA
<http://www.star.nesdis.noaa.gov/sod/lisa/>

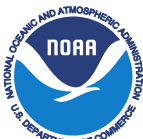

NOAA National Centers for Environmental Information, USA
<http://www.ngdc.noaa.gov>



Geological Institute of Russian Academy of Sciences
Laboratory of Geomorphology and Ocean Floor Tectonics, Russia
<http://atlantic.ginras.ru/index.html>



Scripps Institution of Oceanography
University of California at San Diego
<http://www.sio.ucsd.edu>



Service Hydrographique et Océanographique de la Marine
Brest, France
<http://www.shom.fr>



Instituto Hidrográfico de la Marina
Cádiz, Spain
<http://www.armada.mde.es>



Department of Geological Sciences
Stockholm University, Sweden
<http://www.su.se>

© Copyright International Hydrographic Organization [2012]

This work is copyright. Apart from any use permitted in accordance with the Berne Convention for the Protection of Literary and Artistic Works (1886), and except in the circumstances described below, no part may be translated, reproduced by any process, adapted, communicated or commercially exploited without prior written permission from the International Hydrographic Bureau (IHB). Copyright in some of the material in this publication may be owned by another party and permission for the translation and/or reproduction of that material must be obtained from the owner.

This document or partial material from this document may be translated, reproduced or distributed for general information, on no more than a cost recovery basis. Copies may not be sold or distributed for profit or gain without prior written agreement of the IHB and any other copyright holders.

In the event that this document or partial material from this document is reproduced, translated or distributed under the terms described above, the following statements are to be included:

“Material from IHO publication [reference to extract: Title, Edition] is reproduced with the permission of the International Hydrographic Bureau (IHB) (Permission No/...) acting for the International Hydrographic Organization (IHO), which does not accept responsibility for the correctness of the material as reproduced: in case of doubt, the IHO’s authentic text shall prevail. The incorporation of material sourced from IHO shall not be construed as constituting an endorsement by IHO of this product.”

“This [document/publication] is a translation of IHO [document/publication] [name]. The IHO has not checked this translation and therefore takes no responsibility for its accuracy. In case of doubt the source version of [name] in [language] should be consulted.”

The IHO Logo or other identifiers shall not be used in any derived product without prior written permission from the IHB.

Table of Contents

Contributors	2
Table of Contents	6
List of Figures	12
List of Tables	17
Preface	18
Chapter 1.0 Introduction	19
Approach	19
GRIDDING EXAMPLES	22
Chapter 2.0 Creating a Grid from XYZ Data	22
2.1 <i>Gridding XYZ Data with Generic Mapping Tools (GMT)</i>	22
2.1.1 Downloading Example Data Set	22
2.1.2 Generic Mapping Tools (GMT)	27
2.1.3 Plotting Data with GMT	27
2.1.4 Gridding XYZ Data with GMT	28
2.1.5 What does a Bad Track in a Grid look like?	32
2.2 <i>Gridding XYZ Data with ArcMap</i>	34
2.2.1 Importing XYZ file in ArcMap	34
2.2.2 Reprojecting the data	37
2.2.3 Defining cell resolution for the grid	39
2.2.4 Creating a gridded surface	43
2.2.5 Comparison with original data values	47
FUNDAMENTALS	52
Chapter 3.0 Gathering Software	52
3.1 <i>Generic Mapping Tools</i>	52
Chapter 4.0 Software Overview	54
4.1 <i>ArcGIS</i>	54
4.1.1 What is ArcGIS for Desktop Software?	54
4.1.2 Is the software free, what licences are available and how can you access the software?	54
4.1.3 What type of computer platform does it run on?	55
4.1.4 What does the software do?	55
ArcGIS for Desktop application packages - what are they and what do they do?	55
In what formats and structures does ESRI ArcGIS Desktop software store data?	58
How do you work with your data in ArcGIS Desktop packages - do you have to reformat it?	60
Can you create a 3D surface from your source data sets?	61
Working with your data in ArcMap	63
Example of using ArcMap and ArcScene to help assess a bathymetric grid	65
How can I get help with using the software?	70
4.2 <i>CARIS HIPS (Hydrographic Information Processing System)</i>	71
4.2.1 Introduction	71
4.2.2 Acknowledgements	71
4.2.3 HIPS Workflow	71
4.2.4 Project Data Tree and General Information	72
4.2.5 HIPS Workflow- Detailed	75
4.3 <i>Generic Mapping Tools (GMT)</i>	96
4.4 <i>r2v, Surfer, Global Mapper</i>	96
4.4.1 Able Software Corporation's r2v (raster to vector)	96
4.4.2 Global Mapper Software LLC - Global Mapper 12	97
4.4.3 Golden Software Inc. Surfer® Version 9	97
Grid Construction	97

Chapter 5.0	Gathering Data	101
5.1	<i>NCEI and IHO DCDB Bathymetry Data</i>	101
5.1.1	Discovering and Identifying Data	101
	Navigating the map:.....	102
	Identifying data:	104
	Downloading Data:.....	106
5.2	<i>JAMSTEC Data</i>	110
Chapter 6.0	Data Cleaning.....	117
6.1	<i>Quality Assessment</i>	117
6.1.1	Sources of uncertainty.....	117
	Elevation value	117
	Morphologic change since data collection.....	118
	Data not measuring ground surface.....	118
6.1.2	How to determine data uncertainty	119
6.2	<i>Data Cleaning Techniques</i>	119
6.2.1	Automatic (non-interactive) data cleaning	119
6.2.2	Manual (interactive) data cleaning.....	120
6.2.3	Clipping to polygon or elevation value (e.g., zero).....	120
6.2.4	Common multibeam swath sonar errors	120
	Spikes under nadir	120
	Tracking water-column noise	121
	Roll-over on inward-facing steep slopes.....	121
	Anomalies on outward-facing slopes.....	121
	Navigation missing on first ping.....	121
	Inaccurate sound speed profile used.....	121
6.2.5	Common lidar errors.....	122
	Bomb craters	122
	Vegetation and buildings.....	122
	Water-surface values	122
6.3	<i>Data Validation</i>	122
6.3.1	Internal self-consistency	122
6.3.2	External consistency.....	123
6.3.3	Comparison with reported survey specifications	123
6.4	<i>Use of uncertainty surfaces</i>	123
6.5	<i>Validation Procedures</i>	123
Chapter 7.0	Metadata Documentation	125
7.1	<i>Introduction</i>	125
7.2	<i>Metadata</i>	125
7.3	<i>Point Data Attribution</i>	125
7.4	<i>Bathymetric Model Attribution</i>	126
Chapter 8.0	Gridding Data.....	127
8.1	<i>Introduction to gridding</i>	127
8.1.1	Polynomials	127
8.1.2	Near-neighbor searches.....	127
8.1.3	Triangulation	127
8.1.4	Splines.....	127
8.1.5	Kriging	127
8.2	<i>Examples of gridding methods</i>	127
8.2.1	Gridding JAMSTEC multibeam data.....	127
8.2.2	GMT Surface and Nearneighbor	129
8.2.3	GMT Triangulate.....	130
8.2.4	Spline pyramid	130
8.2.5	Kriging	130

8.2.6	Spline Interpolation	130
8.2.7	Global Mapper	131
8.2.8	r2v.....	131
8.2.9	Surfer.....	131
8.2.10	Gridding in ArcMap.....	133
	Importing .XYZ file in ArcMap.....	133
	Reprojecting the data.....	135
	Defining cell resolution for the grid	136
	Creating a gridded surface.....	140
	Comparison with original data values.....	142
8.2.11	Gridding the International Bathymetric Chart of the Arctic Ocean (IBCAO) Version 3.0.....	145
	Workflow overview	147
	Data preparation and merging – workflow step A	149
	Gridding – Workflow steps B and C.....	152
	Remove-restore – Workflow step D.....	156
	Appendix 1: Python script I.....	161
	Appendix 2: Python script II: the remove-restore procedure	165
	Appendix 3: IBCAO Compilation Team	170
8.3	<i>Testing of gridding methods.....</i>	<i>170</i>
8.3.1	Distance to Control.....	170
8.3.2	Histograms.....	173
8.3.3	Statistical tests	175
8.4	<i>Other routines for use on gridded data</i>	<i>175</i>
	gdal_query.py	176
	update_grid.....	183
	gdal_perspective.py	185
Chapter 9.0	Data Analysis Techniques.....	192
9.1	<i>Computing Coherence on 2-D Grids.....</i>	<i>192</i>
9.1.1	What is Coherence?.....	192
9.1.2	Data Grids.....	192
9.1.3	Grid Preparation.....	193
9.1.4	Coherence Computation	195
9.1.5	Interpreting Coherence Results	196
ADVANCED TOPICS.....		198
Chapter 10.0	Uncertainty	198
10.1	<i>Sources of Uncertainty.....</i>	<i>198</i>
10.2	<i>Measuring uncertainty.....</i>	<i>199</i>
10.2.1	Methods of quality assessment, artifacts	199
10.2.2	Comparisons with multibeam	199
Local	199	
Regional	199	
Global.....	199	
10.2.3	Monte Carlo Technique	199
10.2.4	Bayesian Network Technique	200
Bayesian Network Design and Access.....	201	
Bayesian Network Training Procedures	203	
Operational Flow	207	
10.2.5	Windowed Regression with Kriging Corrections	208
Linear Smoothing by Locally Weighted Regression (Loess).....	209	
Combining windowing with ordinary kriging corrections	211	
10.2.6	Error Growth Model	217
10.2.7	Split-Sample Approach	218
SS_UNC.....	221	

SS_UNC.SCM	230
RSPLIT	240
10.2.8 Spectral analysis.....	246
10.2.9 Slope	246
10.2.10 Kriging discussion and cautionary note	246
10.3 <i>Sharing uncertainty results</i>	246
10.3.1 ASCII files.....	246
10.3.2 netCDF files.....	246
10.3.3 "BAG" files	246
Chapter 11.0 LANDSAT 8 Satellite-Derived Bathymetry	248
11.1 <i>Pre-processing</i>	250
11.1.1 Setting up the workspace (ArcMap).....	250
11.1.2 Importing an Raster Navigation Charts (RNC) into the project.....	256
Downloading a NOAA chart	256
Adding the RNC into the project	257
Referencing a chart.....	259
11.1.3 Control points.....	264
ASCII point cloud	264
SOUNDG S-57 Attribute	266
11.1.4 Satellite layers (Landsat).....	270
11.2 <i>Land/water separation</i>	276
11.2.1 Identifying the threshold values	277
11.2.2 Water body extraction.....	279
11.3 <i>Applying the SDB algorithm and calculating extinction depth</i>	282
11.3.1 Applying the SDB algorithm.....	282
11.3.2 Depth of extinction calculation.....	284
11.4 <i>Vertical referencing</i>	296
11.4.1 Calculating the gain and offset.....	296
11.4.2 SDB - Applying the gain and offset (referencing).....	299
Chapter 12.0 Digital Terrain Map Editing (DTMediting V1.6).....	301
12.1 <i>Toolbar Buttons</i>	301
12.2 <i>Navigation and Editing</i>	302
12.3 <i>Toolbar Menus</i>	302
12.4 <i>Dialogs (accessed from the File menu)</i>	303
12.5 <i>Dialogs (accessed by pressing buttons on the tool bar)</i>	305
12.6 <i>Dialogs (accessed from the Option menu)</i>	307
12.7 <i>Brief Manual (for files that can be handled with available video memory)</i>	309
12.8 <i>Full Manual</i>	309
12.9 <i>Download Link (latest program installation package)</i>	319
12.10 <i>Download and Installation Instructions for Windows 8 and 8.1</i>	319
Chapter 13.0 Uses of CARIS.....	321
13.1 <i>Mosaics in CARIS</i>	321
13.1.1 Steps to get a pretty mosaic of an area (creating beam pattern correction).....	323
Concepts to take into account:.....	327
13.1.2 Steps to get an advanced reflectivity mosaic, by analyzing the sediments.....	328
13.1.3 Image classification.....	342
13.1.4 Print out the analysis of sediments conducted, on the line or lines selected and analyzed ..	346
13.2 <i>Generation of useful layers and files in a BASE surface to ease data processing with CARIS (Version 9)</i>	348
13.2.1 How to generate a layer with the total vertical uncertainty (TVU) of the International Hydrographic Organization (IHO) for one specific survey Order.....	348

13.2.2	How to generate a layer showing the proportion between the Uncertainty and the total vertical uncertainty (TVU) of the International Hydrographic Organization (IHO) for one specific survey Order, generated previously.....	351
13.3	<i>Generation of a file in CARIS to distinguish areas with few soundings</i>	356
Chapter 14.0	Nautical Chart Adequacy Procedure.....	362
14.1	<i>Setting up the workspace (ArcMap)</i>	365
14.2	<i>Loading the dataset into the project</i>	371
14.2.1	Raster Navigation Charts (RNC).....	372
14.2.2	S-57 files from the Electronic Navigation Charts (ENC).....	373
14.2.3	Satellite layers (Landsat).....	375
14.2.4	Automatic Identification System (AIS).....	381
14.3	<i>Reference surface</i>	383
14.4	<i>Bathymetric Difference layer</i>	385
14.4.1	Satellite Derived Bathymetry (SDB) – Land/water separation.....	385
14.4.2	SDB – Applying the bathymetry algorithm.....	391
14.4.3	SDB – Vertical referencing and depth of extinction calculation.....	393
14.4.4	SDB – Applying the gain and offset (referencing).....	406
14.4.5	Generating contour lines (based on the largest-scale chart available).....	407
14.4.6	Comparing between the derived and the charted bathymetry.....	408
14.5	<i>Vessel Traffic layer</i>	418
14.5.1	Calculating the traffic density.....	418
14.5.2	Generating the Vessel Traffic layer.....	421
14.6	<i>Hydrographic Characteristics layer</i>	423
14.6.1	Validation of CATZOC encoding in the MQUAL S-57 attribute.....	423
14.6.2	Input H.C. values using the H.C. Look-up Table.....	425
14.6.3	Convert vector file HC Polygons to an HC raster.....	428
14.7	<i>Chart Adequacy</i>	430
14.7.1	Archiving the layers.....	430
14.7.2	Calculating the adequacy.....	432
14.7.3	Estimating the percentage of inadequate areas for navigation.....	435
	<i>Appendix A – Example for Chart Adequacy Review Template</i>	438
Chapter 15.0	Map Digitizer Program Version 2.1.0.....	439
15.1	<i>Toolbar</i>	440
15.2	<i>Map Parameters</i>	442
15.3	<i>Program Settings Analysis Parameters</i>	444
15.4	<i>Program Paths</i>	445
15.5	<i>DTM Settings</i>	446
15.6	<i>Digitizing with a Mouse</i>	447
15.6.1	Using the Dialog’s Number Pad.....	449
15.7	<i>Digitizing with the 16 button DrawingBoard VI mouse</i>	449
15.8	<i>Digitizing Tools Explanation</i>	450
15.9	<i>Brief Tutorial on creating a DTM model from a topographic map</i>	460
15.9.1	Smoothing the Borders.....	465
15.10	<i>Contouring and Horizon Profiles</i>	467
	GEBCO OCEAN MAP TOPICS	469
Chapter 16.0	Finding Gaps to Map.....	469
16.1	<i>Google Earth Pro and SRTM30_PLUS Overlays</i>	469
16.2	<i>Assessing Gaps via Bathymetric Sounding Density</i>	471
16.3	<i>A GIS Approach to Prioritizing the Gaps to Map</i>	475
16.3.1	General Criteria and Input Parameters.....	476
16.3.2	GIS-Based Suitability Analysis.....	478
16.3.3	Results and Discussion.....	479

Chapter 17.0	Developing a Type Identifier (TID) Grid	481
17.1	<i>Developing the TID Grid from Source Data</i>	485
Annexes	487
Annex A	Additional Resources.....	487
<i>Multibeam Data</i>	487
<i>Bathymetry Models</i>	488
Annex B	Glossary.....	489
<i>S-44 Terms</i>	489
Annex C	Acronyms and Abbreviations.....	491

List of Figures

Figure 2.1	NOAA National Centers for Environmental Information (NCEI) GEODAS website	22
Figure 2.2	Geophysical Survey Data web page.	23
Figure 2.3	Geographic boundaries selection window.	24
Figure 2.4	Search results image.	24
Figure 2.5	Portion of Search Results web page.	25
Figure 2.6	Download Format web page.	26
Figure 2.7	Compress and Retrieve data web page.	26
Figure 2.8	Retrieve download.	26
Figure 2.9	University of Hawaii website for GMT.	27
Figure 2.10	Map of XYZ point locations.	28
Figure 2.11	Grid of XYZ data points, using GMT “surface” with tension set to 0.25.	29
Figure 2.12	Results of gridding XYZ data (black dots) with GMT gridding routines “surface” with tension set to 0 (top left) and set to 1 (top right), “nearneighbor” (bottom left), and “triangulate” (bottom right).	31
Figure 2.13	Grid of estimated depths from altimetric bathymetry model, black dots are ship controls used in model.	32
Figure 2.14	Grid of XYZ data points (left), and grid of same XYZ data points with “bad track” included (right).	33
Figure 3.1	University of Hawaii website for GMT.	52
Figure 3.2	GMT download and installation web page.	53
Figure 5.1	NCEI Bathymetry Data Viewer, displaying Multibeam Bathymetry Surveys. Surveys are color-coded by year (newer surveys are green and older surveys are orange).	102
Figure 5.2	Trackline Bathymetry Surveys	103
Figure 5.3	NOS Hydrographic Surveys	103
Figure 5.4	Extents of Digital Elevation Models, with shaded-relief visualizations.	104
Figure 5.5	After clicking near the Hawaiian Islands, 5 surveys have been identified. EX0909 is highlighted on the map.	105
Figure 5.6	Attributes shown for survey EX0909. For multibeam surveys, click on “Cruise File List” to go to a page where data can be downloaded (described below).	106
Figure 5.7	Multibeam Data download page.	107
Figure 5.8	NOS Hydrographic Survey download page. BAG files are available for this survey.	108
Figure 5.9	Trackline Bathymetry data download page (GEODAS).	109
Figure 5.10	DEM Download Page. Data is provided in ESRI Arc ASCII format.	110
Figure 5.11	JAMSTEC Data Site for Research Cruises.	111
Figure 5.12	KAIREI Research Data web page.	112
Figure 5.13	KR05-01 Cruise web page.	113
Figure 5.14	KR05-01 Bathymetry Data web page.	114
Figure 5.15	KR05-01 Bathymetry Data files available for download.	115
Figure 5.16	JAMSTEC Data Search Portal.	116
Figure 5.17	Data Search Portal Results.	116
Figure 8.1	Color shaded-relief image of gridded KR05-01 multibeam points.	128

Figure 8.2 Results of gridding depths from V12.1* at constrained grid cells (black dots): GMT “surface” gridding routine with tension set to 0 (left) and set to 1 (middle), and “nearneighbor” gridding routine (right).....	129
Figure 8.3 The extent of the IBCAO DBM. Projection: Polar Stereographic, true scale at 75° N, WGS 84 horizontal datum. Depths are referenced to Mean Sea Level.	147
Figure 8.4 Panels A-F describes the most important components in the IBCAO 3.0 compilation process. Figure is modified from Jakobsson et al. (2012).	148
Figure 8.5 Screen view of the GeoMedia Professional GIS workspace with some of the IBCAO source data displayed. The source database resides in several databases that are accessed using GeoMedia Professional. Stored depth data with associated metadata can be displayed and analyzed. In this screen view individual soundings stored as point features are displayed as well as polygons enclosing grids contributed from multibeam surveys. The metadata of the multibeam survey with RV Marcus Langseth 2011 is shown.	149
Figure 8.6 Screen view of the GeoMedia Professional GIS workspace with depth contours from GEBCO shown together with echo soundings from a seismic reflection survey contributed to IBCAO through the Geological Survey of Denmark and Greenland (GEUS). The color coding represents depths. Note how the contours are cropped at the edge of the echo sounding data. If there are noticeable mismatches between soundings and contours, edgematching may have to be carried out by moving the contours to fit the soundings. The general goal for IBCAO has been to remove contours from the compilation and instead grid directly from sounding data.	152
Figure 8.7 JAMSTEC multibeam swaths (red) plotted on bathymetry version 12.1* (left). Map of “distance to control” corresponding to bathymetry version 12.1* (right). Black dots are V12.1* grid cells constrained by ship soundings. V12.1* was created without JAMSTEC data.....	172
Figure 8.8 Results of gridding depths from V12.1* at constrained grid cells (black dots): GMT “surface” gridding routine with tension set to 0 (left) and set to 1 (middle), and “nearneighbor” gridding routine (right).....	173
Figure 8.9 Errors are the absolute value of the differences between multibeam depths from swaths plotted in Figure 8.7 and gridded depths from GMT routines “surface” with tension set to 0 (left) and set to 1 (middle), and from GMT “nearneighbor” (right), plotted against distance from the nearest sounding control.	173
Figure 8.10 Histogram of the differences between multibeam depths from swaths plotted in Figure 8.7 and grids from GMT routines “surface” with tension set to 0 (left) and set to 1 (middle), and from GMT “nearneighbor” (right) depths.....	174
Figure 8.11 Regional depth differences between V12.1 and results from different GMT gridding routines (shown in Fig. 8.8). Black dots are constrained grid cells in V12.1.....	174
Figure 9.1 Multibeam bathymetry (left) and marine gravity (right) on the northern flank of the Pacific-Antarctic spreading ridge.	193
Figure 9.2 Oblique Mercator projected and rotated multibeam (left) and gravity (right) data points. Red box outlines trimming boundary.....	194
Figure 9.3 Multibeam (left) and gravity (right) grids fully prepared for coherence analysis....	195
Figure 9.4 Radial coherence (black line) between grids shown in Figure 9.3. One sigma error bars are plotted.....	196
Figure 10.1 Process flow for the Monte Carlo procedure of Jakobsson et al (2003).	200
Figure 10.2 Conceptual flow of the Bayesian Network approach.....	201

Figure 10.3 Bayesian network topology as displayed by the Netica software GUI. The “Horizontal_Error” node variables follow the navigation errors provided in Table 1, with the numbers for surface navigation error in meters. The “Bottom_Gradient” and “Uncertainty_Estimate” nodes follow a logarithmic binning scheme.....	202
Figure 10.4 High level view of the Bayesian network training process. The figure illustrates computation of the standard deviations as modified from Jakobsson (2003), and use of these results to construct the conditional probability tables (CPT) for the Bayesian network. ...	204
Figure 10.5 Low level flow chart of the Monte Carlo simulations block for the Bayesian network training process. Here, X and Y are the east and north positions of the output grid points in meters after conversion to Universal Transverse Mercator (UTM) projection and specification of a UTM origin in the grid, Z is interpolated depth, S_0 is an unperturbed interpolation, S_{mn} is the perturbed grid for the n^{th} Monte Carlo loop and m^{th} Horizontal Error Category, E' is error from smoothing. The bold face means that the quantity is a vector.	205
Figure 10.6 Low level flow chart of the Standard Deviations block for the Bayes net training process.....	206
Figure 10.7 Low level flow chart of the Bayes network programming block for the Bayesian network training process. The network is stored in a library file that is accessed by API.	207
Figure 10.8 Integrated flow chart of the DBDB-V Uncertainty Expert System (DUES) after programming of the Bayes network component is complete.....	208
Figure 10.9 Equivalent kernel weights for linear and quadratic loess windows.	211
Figure 10.10 Example histogram output from Split-Sample program SS_UNC.....	219
Figure 11.1 Bands of Landsat 7 and 8 imagery used in the SDB procedure.	248
Figure 13.1 Steps to create a Mosaic.	321
Figure 13.2 Images provided by the Spanish Navy survey vessel “Antares,” during the hydrographic survey conducted in Galicia coastal waters (northwestern Spain). This coast is also known as “The coast of death.” This specific area is the Muros Inlet.	322
Figure 13.3 Mosaic and image classification.....	322
Figure 13.4 Create GeoBar.	323
Figure 13.5 Create beam pattern.	324
Figure 13.6 Save beam pattern as “bpt” file.	324
Figure 13.7 Select processing options.	325
Figure 13.8 Applying GeoBars to all lines. The resolution is the same for all lines.	325
Figure 13.9 Create mosaic.	326
Figure 13.10 Final mosaic.....	327
Figure 13.11 Example of a general area.	329
Figure 13.12 Selected zone in the general area to analyze sediments.	329
Figure 13.13 Enlargement of selected Zone.	330
Figure 13.14 Parameters to select in the ‘process’ tab of the ‘mosaic editor’ window- creating a field sheet (red circle), and opening the mosaic “mosaic editor” window (yellow circle).	331
Figure 13.15 Selection of line to be analyzed.....	332
Figure 13.16 Parameters of the process tab in the mosaic editor window.....	332
Figure 13.17 Parameters of the analysis tab in the mosaic editor window.....	333
Figure 13.18 Image after pressing “analyze” button. Each point, from centerline to both sides, represents grain size, roughness, volume backscatter, and impedance.....	333
Figure 13.19 Illustration of output.	334
Figure 13.20 Sediment analysis options.	334

Figure 13.21 Advanced button.....	335
Figure 13.22 Sediment analysis graph options.	335
Figure 13.23 Three different zones of the same line, showing differences obtainable by analyzing the sediments with the model.....	336
Figure 13.24 Grain size table.....	337
Figure 13.25 Class and grain size.	338
Figure 13.26 Select mosaic layer to classify.....	339
Figure 13.27 Classification options.	339
Figure 13.28 Apply classification options.	340
Figure 13.29 Save crf file.....	341
Figure 13.30 Image classification.	341
Figure 13.31 Examples of created interpolation mosaics.	342
Figure 13.32 Classify mosaic layer.....	343
Figure 13.33 Classification with intensity.	344
Figure 13.34 Save crf file.....	344
Figure 13.35 Mosaic and classification image from step 1.	345
Figure 13.36 Mosaic and image classification from step 1.	346
Figure 13.37 Select data in ASCII format.	347
Figure 13.38 List of parameters.	347
Figure 13.39 Possible outcome.	348
Figure 13.40 BASE layer.....	350
Figure 13.41 Layer Window.	350
Figure 13.42 Enter TVU formula.....	351
Figure 14.43 Layer with properties displayed.	351
Figure 13.44 Window with survey Order information.	352
Figure 13.45 Layer with Order information.	353
Figure 13.46 Image showing places where hydrographer will have to spend more time editing than in the rest of the survey, mainly in the area below the isobaths of 100 meters.	354
Figure 13.47 Window with Special Order information.	355
Figure 13.48 Window with uncertainty and TVU layer information.	355
Figure 13.49 Values in red, green and blue are 0.2, 0.3 and 0.4 respectively, from the proportion between uncertainty and TVU layer of Special Order from the IHO.	356
Figure 13.50 Properties to highlight high values.	356
Figure 13.51 Illustration of the density of soundings per node in the BASE surface.....	357
Figure 13.52 Make new file.....	357
Figure 13.53 Select color.	358
Figure 13.54 Add color value.	358
Figure 13.55 Add second color value.	358
Figure 13.56 Color map editor.....	359
Figure 13.57 List color files.....	359
Figure 13.58 Select color file in properties.....	360
Figure 13.59 Survey colored for sounding density (left) and BASE layer (right).....	360
Figure 14.1 Schematic illustration of the four source layers used in NCAE algorithm.	363
Figure 16.1 Website for downloading Google Earth Pro.	470
Figure 16.2 SRTM30_PLUS.kmz displayed in Google Earth Pro.	471
Figure 16.3 NOAA GeoPlatform web page for the Bathymetry Gap Analysis.	473

Figure 16.4 The Bathymetry Gap Analysis as depicted in Esri’s online map viewer application.	474
Figure 16.5 The bathymetry gap analysis as a layer in the U.S. Federal Mapping Coordination website (www.fedmap.seasketch.org).	475
Figure 16.6 Overview map of the study area showing available multibeam data coverage from the IHO DCDB, GMRT Synthesis, EMODnet and from the Spanish and Portuguese national archives (from Wöfl et al. (2017) with permission of The Journal of Ocean Technology).	477
Figure 16.7 GIS parameter layers for the GIS suitability analysis: A. Category I, Environmentally-sensitive areas, B. Category II, Areas of public interest, C. Category III, Areas with marine resource potential (from Wöfl et al. (2017) with permission of The Journal of Ocean Technology).	478
Figure 16.8 Workflow of data preparation and GIS suitability analysis (from Wöfl et al. (2017) with permission of The Journal of Ocean Technology).	479
Figure 16.9 (Left) Result map showing the suitability of potential target sites and the percentage of multibeam data coverage divided into four classes. High suitability regions are highlighted (dotted line). (Right) The three selected regions showing not only a high occurrence of desired attributes, reflected in a high suitability class, but also relatively low multibeam data coverage. From Wöfl et al. (2017) with permission of The Journal of Ocean Technology.	480
Figure 17.1 The TID Grid that accompanies the GEBCO_2019 bathymetric grid.	482
Figure 17.2 Example section of the TID grid.	484
Figure 17.3 Showing how coding areas of ‘pre-generated grid’ with the contributing data type codes helps identify regions in the global grid that are based on interpolation.	485

List of Tables

Table 8.1 Minimum metadata requested for bathymetric data contributed for inclusion in the IBCAO	150
Table 10.1 Navigation uncertainty categories used in Elmore et al. (2009) for the Bayesian Network approach to uncertainty estimation. The abbreviations are as follows: GPS – Global Positioning System; SINS – Ship’s Inertial Navigation System; DR – Dead Reckoning; NAVSAT – Navy Navigation Satellite System; LORAN – Long Range Navigation. The “/” means that two or more techniques are combined.	203
Table 11.1 Recommended SDB imagery bands from different platforms.	249
Table 13.1 IHO Orders.	348
Table 13.2 Order values.	349
Table 13.3 New layer generated to know data quality acquired in a survey, in accordance with the survey Order.....	352
Table 13.4 Value interval.....	353
Table 13.5 An example to show only the high values with the filter, in properties.	354
Table 13.6 Uncertainty values.	355
Table 13.7 Values obtained in the proportion of Figure 13.48.	356
Table 14.1 Ranking of the Hydrographic Characteristics classes based on the three survey qualifiers (bottom coverage, survey date and survey technology).	364
Table 14.2 S-57 TECSOU codes (definitions from IHO S-32).	427
Table 17.1 List of TID data type codes and definitions.....	483

Preface

At its 26th meeting in Brest, France, in October 2010, the GEBCO Guiding Committee (GGC) approved a proposal from its Technical Sub-Committee on Ocean Mapping (TSCOM) that they prepare a publication to be called the "GEBCO Cook Book" to provide an educational resource for a wide range of persons interested in preparing gridded datasets from bathymetric data.

This publication includes inputs from a wide range of individuals and organizations all of whom are experts in their respective fields, as set out in more detail in the opening pages and in Chapter 1. It is intended that this will be a living document that will be maintained on a continuous basis as new or amended techniques and software become available. Future updates will be prepared by the Chief Editor under the direction of TSCOM and endorsed by the GGC. Dr. Karen Marks of NOAA has acted as the Chief Editor on behalf of TSCOM for the preparation of the initial text.

The initial text was endorsed by the GGC at its 28th meeting in San Diego, USA, in October 2011, adopted by the IHO as announced in CL 47/2012 in May 2012, and approved by the IOC Executive Council in October 2012.

The IHO-IOC GEBCO Cook Book, IHO Publication B-11, is available for free download via links from the GEBCO web site (<http://www.gebco.net>) and the IHO Publication download web page http://www.iho.int/iho_pubs/IHO_Download.htm. This publication is also available as IOC Manuals and Guides, 63 on the IOC website <http://www.ioc-unesco.org/documents>.

The citation format is:

International Hydrographic Organization, Intergovernmental Oceanographic Commission, The IHO-IOC GEBCO Cook Book, IHO Publication B-11, Monaco, Oct. 2019, 493 pp – IOC Manuals and Guides 63, France, Oct. 2019, 493 pp.

Chapter 1.0 Introduction

GEBCO, the General Bathymetric Chart of the Oceans, is a joint project of the International Hydrographic Organization (IHO) and the Intergovernmental Oceanographic Commission (IOC) bringing together an international group of experts whose aim is to provide the most authoritative publicly available bathymetry of the world's oceans, for scientific and educational use. GEBCO welcomes and encourages new contributions of data and expertise from all over the world.

One of GEBCO's products is a global gridded bathymetry data set. This grid contains depth (and, on land, elevation) estimates on a 30 arc-second mesh, which near the equator is about a one-kilometer spacing. Over the oceans, seafloor depths are from ship soundings, and where there are no soundings depths are interpolated, using estimates from satellite altimetry as a guide. The global bathymetry grid is periodically updated by incorporating additional bathymetric survey data, new compilations, and improved data. With this document, the "GEBCO Cook Book," we hope to enable more people to contribute data and gridded compilations to GEBCO.

The Cook Book contains chapters that span basic to advanced topics. These have been written by expert GEBCO contributors from more than a dozen international research organizations, universities, governments, and companies. The Cook Book is a "living document" that will be continually updated and expanded as new contributions are received, and as the GEBCO community's sense of best practices evolves. The Cook Book is available for free download from the GEBCO website (<http://www.gebco.net>).

Approach

The Cook Book is composed of four main sections- "Gridding Examples," "Fundamentals," "Advanced Topics," and "GEBCO Ocean Map Topics."

Cookbook Sections

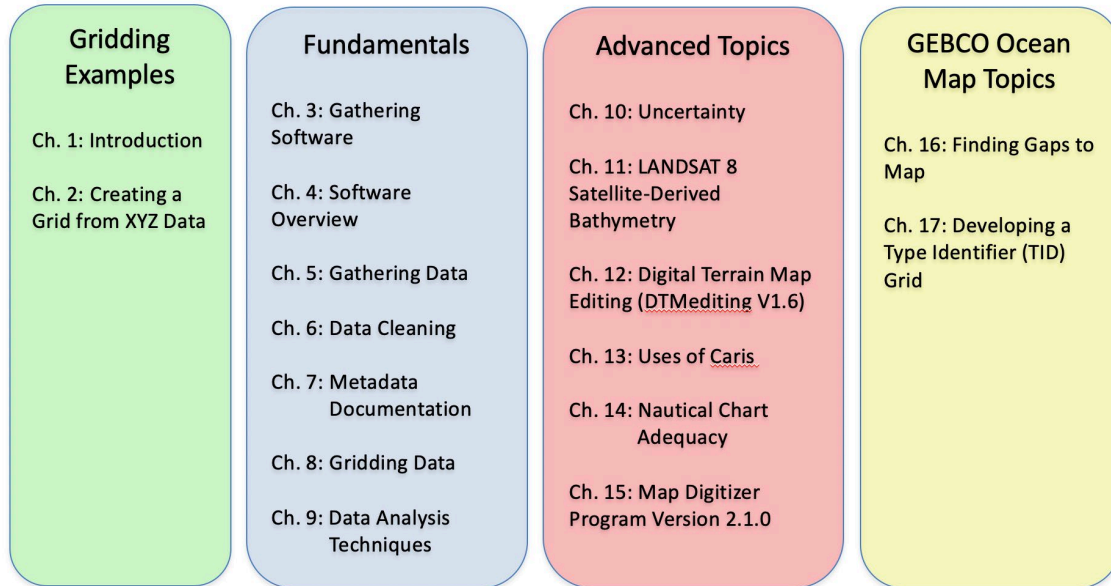

We start with gridding examples so that beginning users desiring to straightaway produce a grid from xyz data can do so by delving into the first section. We make available an example xyz data set through Internet download and also show an alternate method to obtain it through the National Centers for Environmental Information (NCEI) website. A brief overview of gridding software packages, some of which are freely available for download from the Internet, is provided. Illustrated step-by-step instructions that include command lines to process and grid xyz data using the various software packages are listed. The command lines can be cut-and-paste onto the user's computer and, along with the example xyz data, the user can reproduce the results shown in the Cook Book and then apply the same technique to their own data. The results are displayed in maps and plots that can be reproduced with the given command lines as well. This step-by-step approach also allows us to encourage users, once they are familiar with running the example command lines and producing grids and maps, to try changing the command options so that they can see for themselves how the changes affect the final result.

The second section, "Fundamentals," gives a more in-depth look at topics related to preparing, processing, and gridding xyz data. An overview of various gridding software packages, including ArcGIS, CARIS HIPS, Generic Mapping Tools (GMT), r2v, Surfer, and Global Mapper, is included. Also covered are the topics of data cleaning, assessing data quality, validation, metadata documentation, discussion on the various gridding techniques and data analysis techniques.

The third section, "Advanced Topics," contains discussions that more experienced users may find useful. Uncertainties are covered in detail- its sources, and methods of measurement

including Monte Carlo and Network techniques, windowed regression, error growth models, and more. Methods of sharing uncertainty results in the form of ASCII, netCDF, and "BAG" files is included. There are also chapters on deriving bathymetry from LANDSAT 8 satellite data, digital terrain map editing using DTMediting software, creating mosaics using CARIS software, procedures for assessing nautical chart adequacy, and a map digitizer program. A chapter on finding gaps to map helps users locate areas of seafloor without bathymetric soundings.

The fourth section, "GEBCO Ocean Map Topics," presents several methods for finding gaps to map, and also an introduction to developing a Type Identifier (TID) grid to accompany gridded bathymetry data submissions for inclusion in the global GEBCO grid.

Lastly, three Annexes are provided. Annex on Additional Resources enables the user to find more information and includes a list of websites from institutions and organizations that make multibeam data available for public Internet download. An Annex containing a Glossary as well as an Annex with Acronyms and Abbreviations are also provided.

We note that the IHO, IOC, GEBCO, and the contributing authors and institutions do not endorse or promote any particular software package or software provider. The information in this document is provided to benefit the user in good faith but the accuracy and completeness cannot be guaranteed.

GRIDDING EXAMPLES

Chapter 2.0 Creating a Grid from XYZ Data

This chapter provides step-by-step instructions that will show a user how to process and grid xyz data. An example data set is made available so the user can follow along on their own computer.

2.1 Gridding XYZ Data with Generic Mapping Tools (GMT)

Contributed by K. M. Marks, NOAA Laboratory for Satellite Altimetry, USA

Updated by Karolina Chorzewska, University of New Hampshire, USA

2.1.1 Downloading Example Data Set

In this section we demonstrate how to create a grid from xyz bathymetry data. The data set used in this demonstration is available for download from

<ftp://ftp.star.nesdis.noaa.gov/pub/socd/lsa/karen/outgoing/ngdc.topo.xyz>

These data may also be downloaded directly from the NOAA National Centers for Environmental Information (NCEI, formerly NGDC) website as follows. First, access the GEODAS (GEOphysical DATA System) webpage at <http://www.ngdc.noaa.gov/mgg/gdas/>, which is shown in Fig. 2.1.

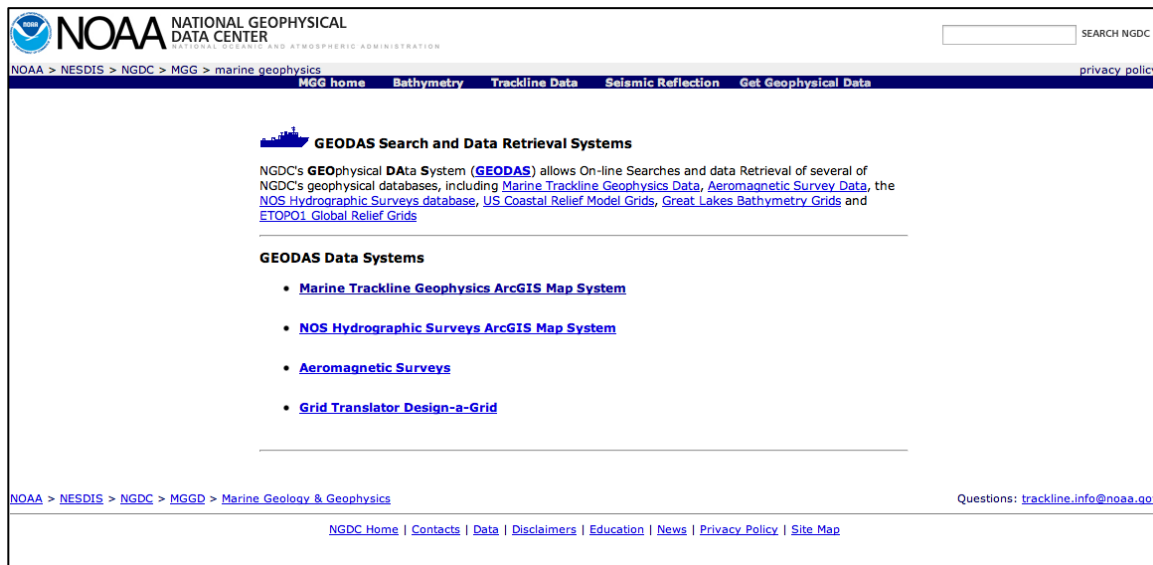

Figure 2.1 NOAA National Centers for Environmental Information (NCEI) GEODAS website

Select "Marine Trackline Geophysics ArcGIS Map System" to reach the Geophysical Survey Data web page (see Fig. 2.2 below).

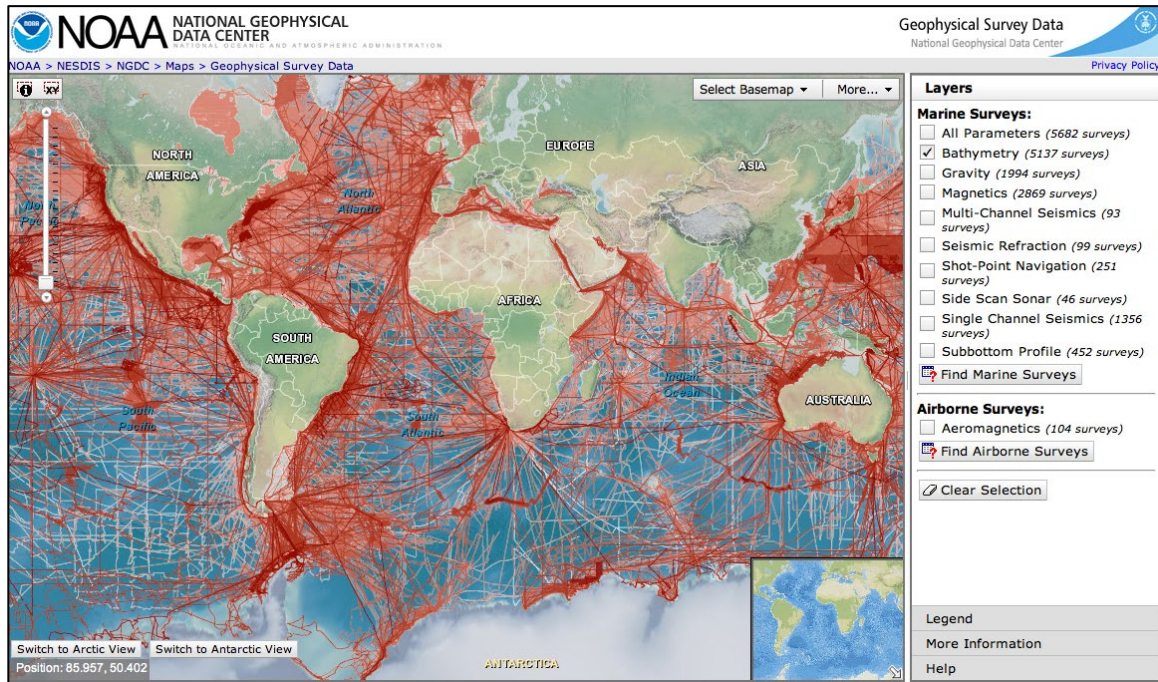

Figure 2.2 Geophysical Survey Data web page.

Check “Bathymetry” in the “Layers” window on the right side of the screen (Fig. 2.2). Click the XY icon (“Identify with Coordinates”) in the top-left corner of the map (also Fig. 2.2). It will open a “Specify an Area of Interest” window (see Fig 2.3 below). Our data set ranges from 15 to 20 N latitude, and from 150 to 154 E longitude. The user should enter these geographic coordinates into the corresponding boxes, and then press “OK.”

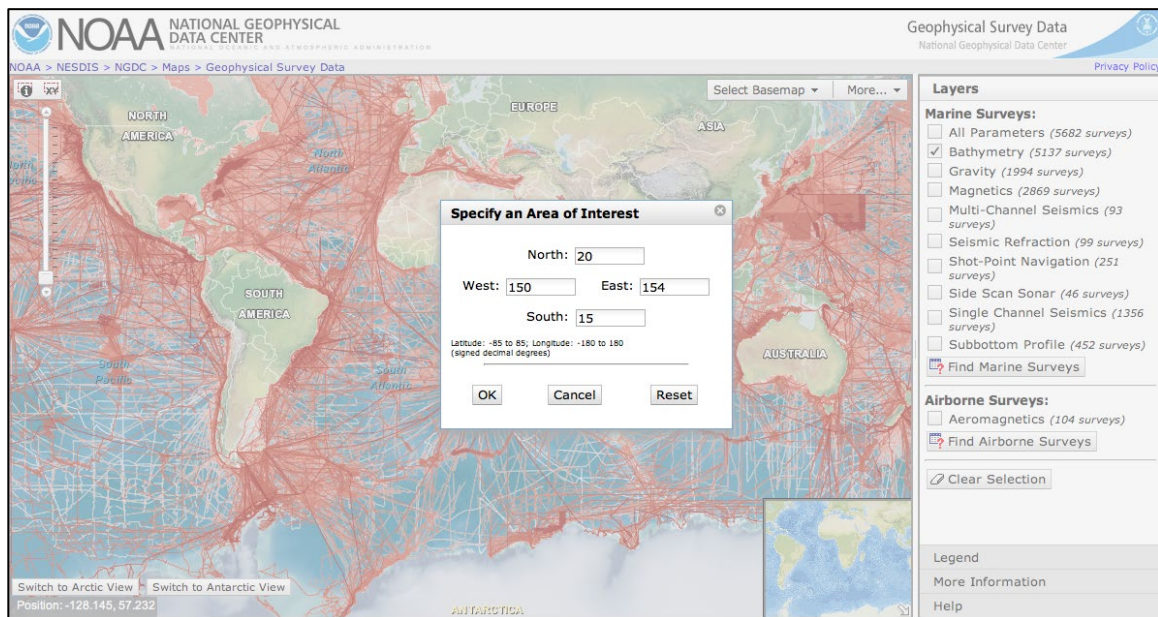

Figure 2.3 Geographic boundaries selection window.

The specified area's boundary is now shown on the map and available surveys are listed in the "Identified Features" window (see Fig. 2.4 below).

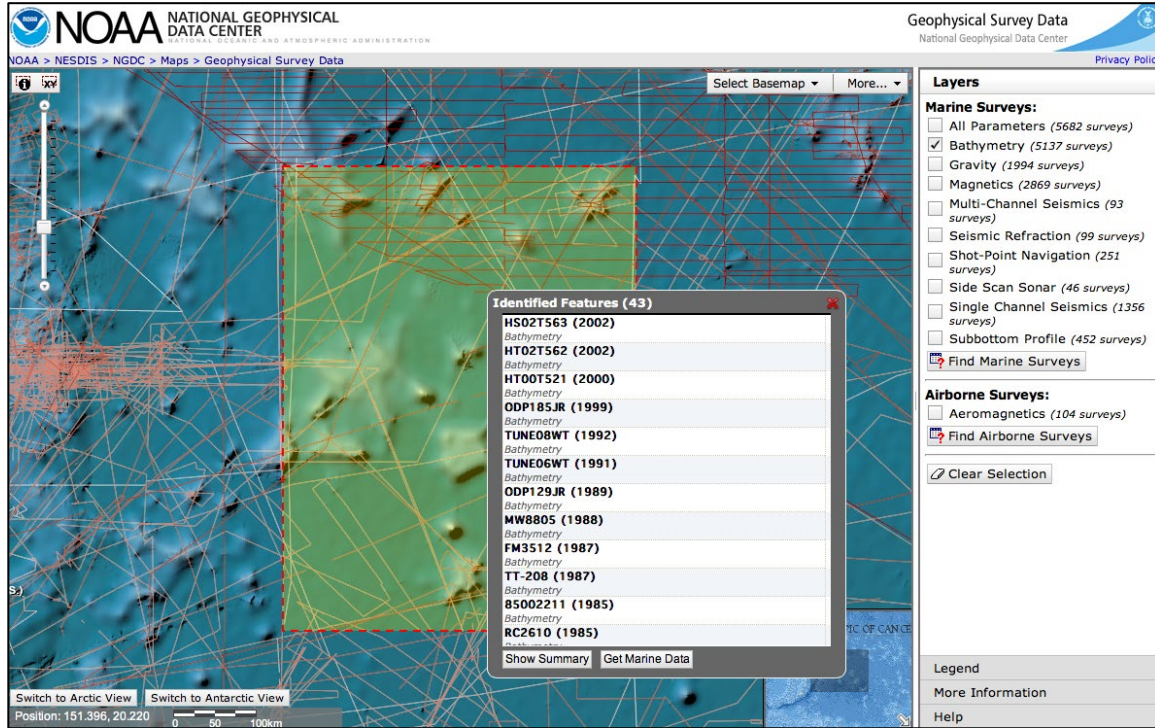

Figure 2.4 Search results image.

Select "Get Marine Data." The results of the search are displayed (see Fig. 2.5 below). Select "Download MGD77-type Data."

NOAA > NESDIS > NGDC > Marine Geology & Geophysics > Geophysics

NOAA NATIONAL GEOPHYSICAL DATA CENTER

Marine Trackline Data

Search Results Listing 2013/06/03 Search Key: GD190646

Download MGD77-type Data

Search Criteria:

SEARCH LIMITS:

150.000 20.000 154.000
15.000

SURVEYED PARAMETERS:
Bathymetric Soundings

Trackline Geophysical Data Summary

Defense Mapping Agency									
Source	NGDC-Id	Nav	Bath	Mag	Grav	SC Seis	MC Seis	Sub-Bot	Shot-Pt
10075	35320002	digital	digital						data plot
27474	35320001	digital	digital						data plot

France IPREMER									
Source	NGDC-Id	Nav	Bath	Mag	Grav	SC Seis	MC Seis	Sub-Bot	Shot-Pt
85002211	67010148	digital	digital	digital					data plot

Hawaii, U of									
Source	NGDC-Id	Nav	Bath	Mag	Grav	SC Seis	MC Seis	Sub-Bot	Shot-Pt
76010301	08010077	ana+dig	digital		analog	analog		analog	data plot
76010302	08010033	ana+dig	digital	ana+dig	ana+dig	analog		analog	data plot
77031703	08010067	ana+dig	digital	ana+dig	ana+dig	analog		analog	data plot
81062603	08010081	ana+dig	digital	digital	digital	analog		analog	data plot
81062604	08010061	ana+dig	ana+dig	digital	digital	analog		analog	data plot
MW8805	08020050	ana+dig	digital	digital	digital	analog		analog	data plot

Japan Hydrographic Dept									
Source	NGDC-Id	Nav	Bath	Mag	Grav	SC Seis	MC Seis	Sub-Bot	Shot-Pt
HS027563	J1020060	digital	digital	digital	digital				data plot
HT007521	J1010134	digital	digital	digital	digital				data plot
HT027562	J1010139	digital	digital	digital	digital				data plot

Figure 2.5 Portion of Search Results web page.

The desired format of the downloaded data can be designated next (see Fig. 2.6 below). For our data set, select "Single File of All Survey Data in Area," "Space Delimited XYZ Format," and select Longitude, Latitude, and Corrected Depths (meters) in the box. Then press the "Process Digital MGD77T-type Data" button.

NOAA > NESDIS > NGDC > Marine Geology & Geophysics > Geophysics

NOAA NATIONAL GEOPHYSICAL DATA CENTER

Marine Geophysical Data

Process MGD77T-type Digital Data for Download [help](#)

Reset Process Digital MGD77T-type Data Skip This

Download File-saving Options

Single File of All Survey Data in Area

Multiple Survey Files, Data in Search Area

Multiple Survey Files, Complete Surveys

Format of Output Data

MGD77T Tab-Delimited Format

Legacy MGD77 ASCII Exchange Format

Space Delimited XYZ Format

Longitude
Latitude
(choose 2 field)

Uncorrected Depth (meters)

Corrected Depth (meters)

Mag Total Field (gammas)

Mag Res. Field (gammas)

Grav Observed (mgals)

Grav Free Air (mgals)

Download Only Records containing selected Parameters:

ALL PARAMETERS

Bath 2-Way Travel Time

Bath Corrected Depth

Mag Total Field 1

Mag Total Field 2

Mag Residual Field

Grav Observed

Grav Free Air

Seis Shot Pt Num

Use legacy NGDC Numbers for survey file names

Figure 2.6 Download Format web page.

A web page notifying the user that the data have been processed and are available for retrieval comes up next (see Fig. 2.7 below). Press the "Compress and Retrieve Your Data" button. The GEODAS system has assigned the arbitrary name "GD190646" to the data set.



Figure 2.7 Compress and Retrieve data web page.

The next web page provides information about retrieving the data (see Fig. 2.8 below). Push the "Retrieve" button to download the data set. If the download file size is particularly large, select "Retrieve Compressed File" next to the retrieve button to reduce the size of the download file. The data file is then downloaded onto the user's computer.

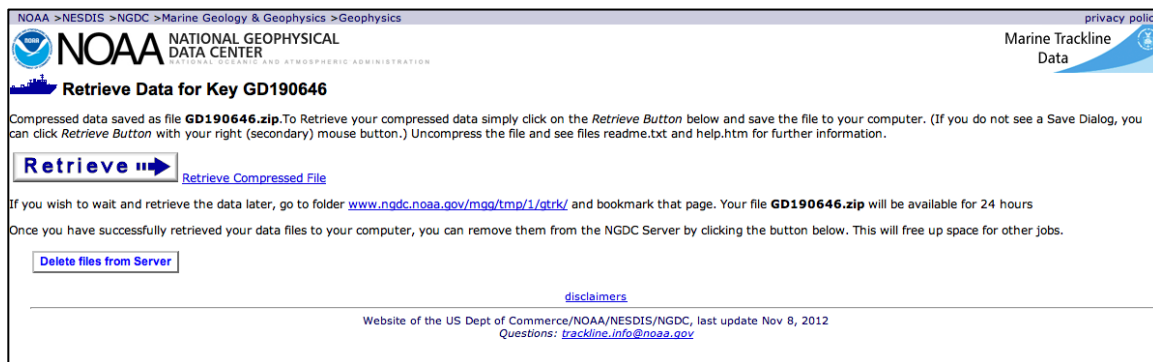
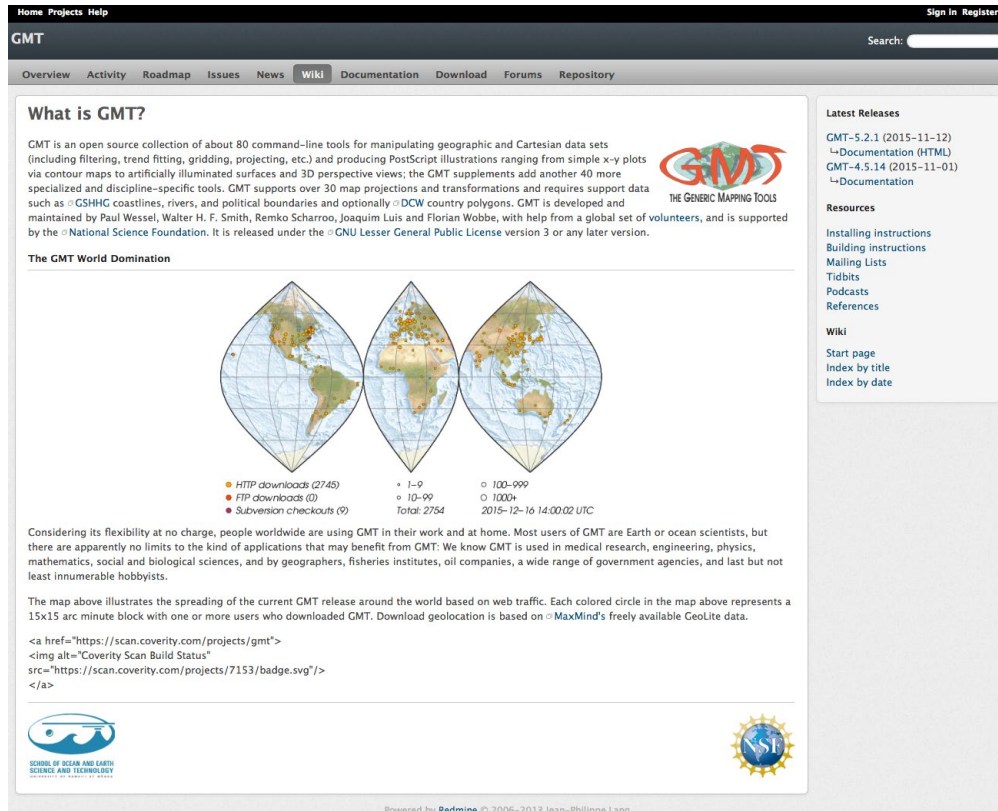

Figure 2.8 Retrieve download.

The data are downloaded (or uncompressed) as a directory (e.g., `geodas_GD190646`) on the user's computer. Within the directory are documents, readme information, and the data file (`GD190646.xyz`). We chose to rename the xyz data set "`ngdc.topo.xyz`."

2.1.2 Generic Mapping Tools (GMT)

GMT (Generic Mapping Tools) (Wessel and Smith, 1998) is a collection of open source mathematical and mapping routines for use on gridded data sets, data series, and arbitrarily located data. The GMT package is available for download from the University of Hawaii website (<http://gmt.soest.hawaii.edu/>) (see Fig. 2.9). We utilized GMT routines for our gridding and mapping examples shown in this section. Actual GMT command lines are provided in the discussions that follow.



The screenshot shows the GMT website homepage. At the top, there is a navigation bar with links for Home, Projects, and Help. Below this is a search bar and a secondary navigation menu with links for Overview, Activity, Roadmap, Issues, News, Wiki, Documentation, Download, Forums, and Repository. The main content area is titled "What is GMT?" and contains a paragraph describing the software. To the right of this text is the GMT logo and the text "THE GENERIC MAPPING TOOLS". Below the text is a world map showing the distribution of GMT downloads, with colored circles indicating the location of each download. A legend below the map provides statistics: HTTP downloads (2745), FTP downloads (0), Subversion checkouts (0), and a total of 2754 downloads. The legend also includes a date range of 2015-12-16 14:00:02 UTC. Below the map is a paragraph explaining the map's data source and a code snippet for a coverity scan badge. At the bottom of the page, there are logos for the School of Ocean and Earth Science and Technology and the University of Hawaii, along with a footer indicating the site is powered by Redmine.

Figure 2.9 University of Hawaii website for GMT.

2.1.3 Plotting Data with GMT

It is desirable to plot the xyz data on a map to see the locations of the points. The xyz data may be plotted on a map using Generic Mapping Tools (GMT).

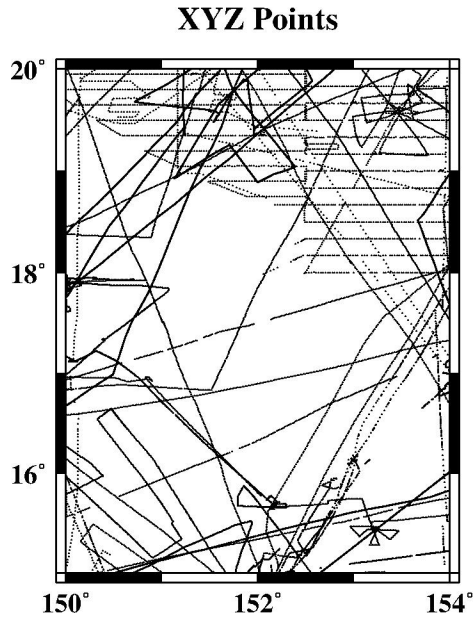

Figure 2.10 Map of XYZ point locations.

Figure 2.10 (above) was produced with the following GMT commands:

```
psbasemap -R150/154/15/20 -Jm0.5 -Ba2f1.: "XYZ Points":WeSn -K > Fig.2.10.ps  
psxy ngdc.topo.xyz -R -Jm -Sp -O >> Fig.2.10.ps
```

It is useful to note the distribution of the data points. In the center of the map there are few ship tracks, leaving large areas with no bathymetry measurements. In the northeastern corner, there is systematic survey coverage.

2.1.4 Gridding XYZ Data with GMT

It is possible to create a grid from the randomly located xyz data points. GMT routine "surface" is an adjustable tension continuous curvature gridding algorithm that can be used to grid the xyz data. We input the xyz data into "surface," setting the tension factor to 0.25 (surface tension set to "0" gives the minimum curvature solution, and set to "1" gives a harmonic surface where maxima and minima are only possible at control points). Figure 2.11 (below) shows the resulting grid.

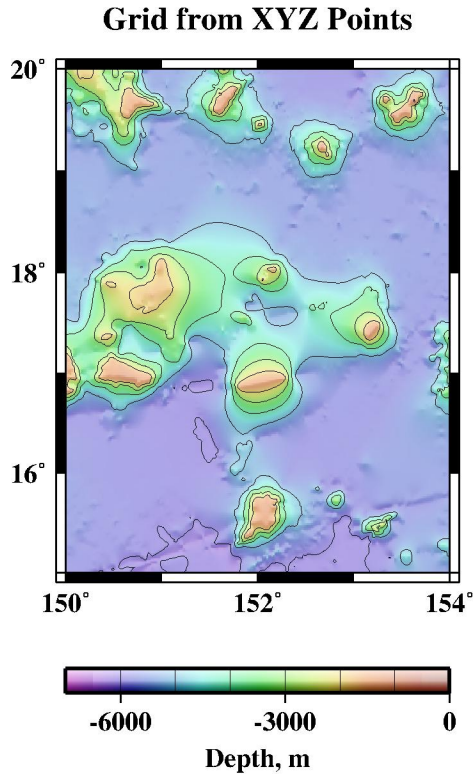

Figure 2.11 Grid of XYZ data points, using GMT “surface” with tension set to 0.25.

The GMT commands used to produce the gridding solution and plot it in Fig. 2.11 follow.

```

surface ngdc.topo.xyz -R150/154/15/20 -I1m -T0.25 -Gngdc.topo_grd
grdgradient ngdc.topo_grd -A0 -Ne0.2 -Ggrad_grd
grdimage ngdc.topo_grd -lgrad_grd -Ctopo.cpt -Jm0.5 -K>Fig.2.11.ps
pscoast -G175 -R150/154/15/20 -Jm0.5 -W2 -Df -Ba2f1:."Grid from XYZ Points":WeSn
-K -O>>Fig.2.11.ps
grdcontour ngdc.topo_grd -R -Jm -C1000 -W1 -K -O>>Fig.2.11.ps
psscale -D1/- .5/2/.125h -Ctopo.cpt -Ba3000g1000:"Depth, m": -l -N300 -O >>Fig.2.11.ps

```

The color palette table (topo.cpt) is:

-7000	300	.350000	.85	-6500	275.625	.350000	.85
-6500	275.625	.300000	.90	-6000	250.3125	.300000	.90
-6000	250.3125	.300000	.90	-5500	225	.300000	.90
-5500	225	.300000	.90	-5000	199.6875	.300000	.90
-5000	199.6875	.300000	.90	-4500	175.3125	.300000	.95
-4500	175.3125	.300000	.95	-4000	150	.350000	.95
-4000	150	.350000	.95	-3500	125.625	.350000	.95
-3500	125.625	.350000	.95	-3000	99.375	.350000	.95
-3000	99.375	.350000	.95	-2500	75	.350000	.95
-2500	75	.350000	.95	-2000	50.625	.350000	.95
-2000	50.625	.350000	.95	-1500	25.3125	.350000	.95
-1500	25.3125	.350000	.95	-500	10	.250000	.85
-500	10	.200000	.85	0	10	.150000	.80
B	300	.350000	1				
F	0	0.00000	1.0				

The color palette file above specifies the depth ranges (in meters) over which colors are assigned by the HSV (Hue, Saturation, Value) color system. The color palette file is entered into GMT

routine "grdimage" above via the "-C" command line argument. Online GMT documentation (<http://gmt.soest.hawaii.edu>) provides details about color palette files and various color systems.

There are other algorithms that can be used to grid the xyz data points, and each will produce a different solution; the differences are most evident in areas where there are large gaps between measurements. Changing the tension parameter in GMT "surface" will also produce a different solution. "Nearneighbor" uses a nearest neighbor algorithm to assign an average value within a radius centered on a node. "Triangulate" performs optimal Delaunay triangulation. We show the results of GMT "surface," "nearneighbor," and "triangulate" gridding algorithms below.

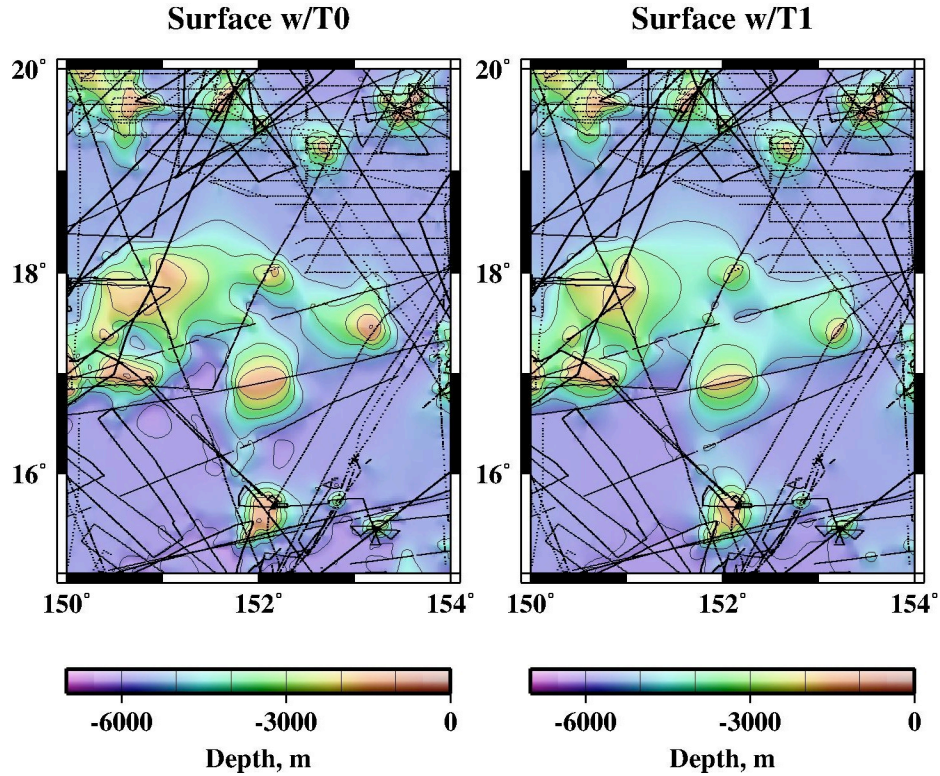

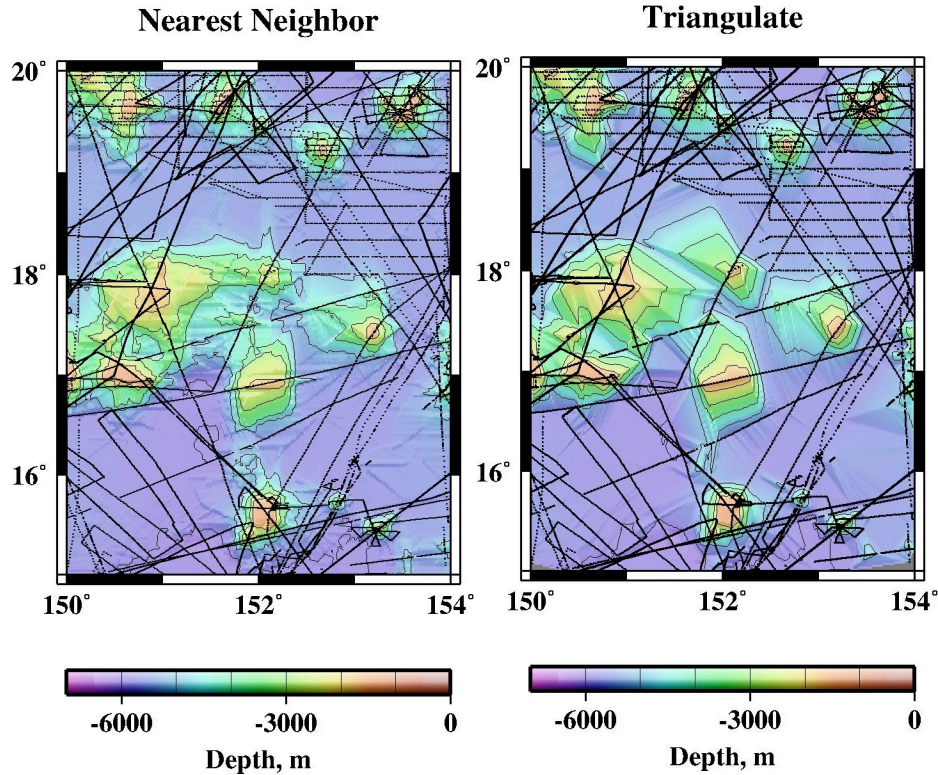

Figure 2.12 Results of gridding XYZ data (black dots) with GMT gridding routines “surface” with tension set to 0 (top left) and set to 1 (top right), “nearest neighbor” (bottom left), and “triangulate” (bottom right).

The command lines used for the corresponding GMT gridding routines follow. The commands to plot the figures are the same as listed for Fig. 2.11, and the color palette file is the same.

```
surface ngdc.topo.xyz -R150/154/15/20 -I1m -T0 -Gngdc.topo_grd
surface ngdc.topo.xyz -R150/154/15/20 -I1m -T1 -Gngdc.topo_grd
nearest neighbor ngdc.topo.xyz -R150/154/15/20 -N4/1 -S100k -I1m -Gngdc.topo_grd
triangulate ngdc.topo.xyz -R150/154/15/20 -I1m -Gngdc.topo_grd > junk
```

Each gridding algorithm produces a very different result because each one uses a different method of interpolating depth estimates in the gaps between data points. Where the gaps are large, areas of shallower seafloor (orange-yellow colored anomalies) appear to follow the ship tracks. This is because ships collect depth measurements along one-dimensional tracks without detecting seafloor away from the track. Seafloor can be mapped in two dimensions when the survey coverage is adequate (for example, in the northeast corner of the study area).

Bathymetry models that estimate depths from a combination of ship measurements and depths derived from satellite gravity can also map the seafloor in two dimensions. Fig. 2.13 below shows the Smith and Sandwell (1997) bathymetry model (version 13.1) over our study area.

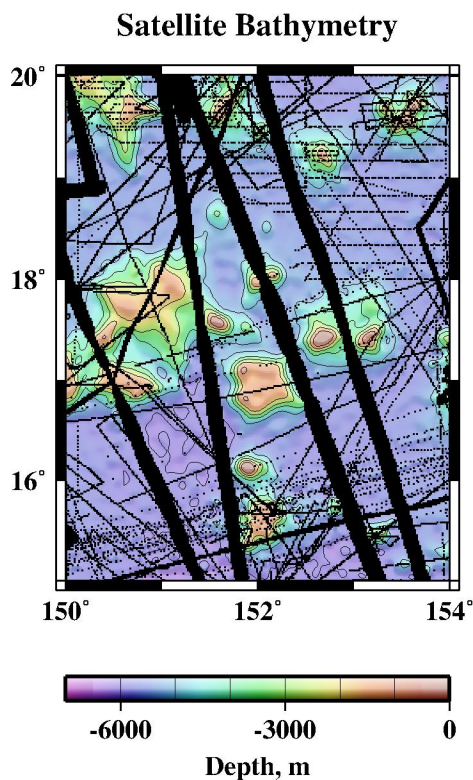

Figure 2.13 Grid of estimated depths from altimetric bathymetry model, black dots are ship controls used in model.

It is important to note that some bathymetry anomalies lie in gaps between ship controls (black dots), and are also mapped away from the ship tracks. Because bathymetry models incorporate depths estimated from satellite gravity and the satellite tracks have ~4 km uniform spacing over the oceans, bathymetry anomalies are accurately mapped in two dimensions. Grids created only from xyz data containing large gaps may not accurately map the seafloor located between the ship tracks.

In our experience, GMT "surface" with a tension set to 0.25 produces a nice-looking bathymetry grid.

2.1.5 What does a Bad Track in a Grid look like?

Gridding algorithms simply ingest the xyz data supplied, and produce a grid. If the xyz data contain errors, they may be visible in the resulting grid. A common problem is a "bad track," where the ship data along a track are poor, which can result from a variety of reasons. To demonstrate what a "bad track" in a grid looks like, we added 2000 m to the depths of track 01010060 (NGDC ID number) and combined it with the example xyz data set and gridded it using routine GMT "surface" (see Fig. 2.14).

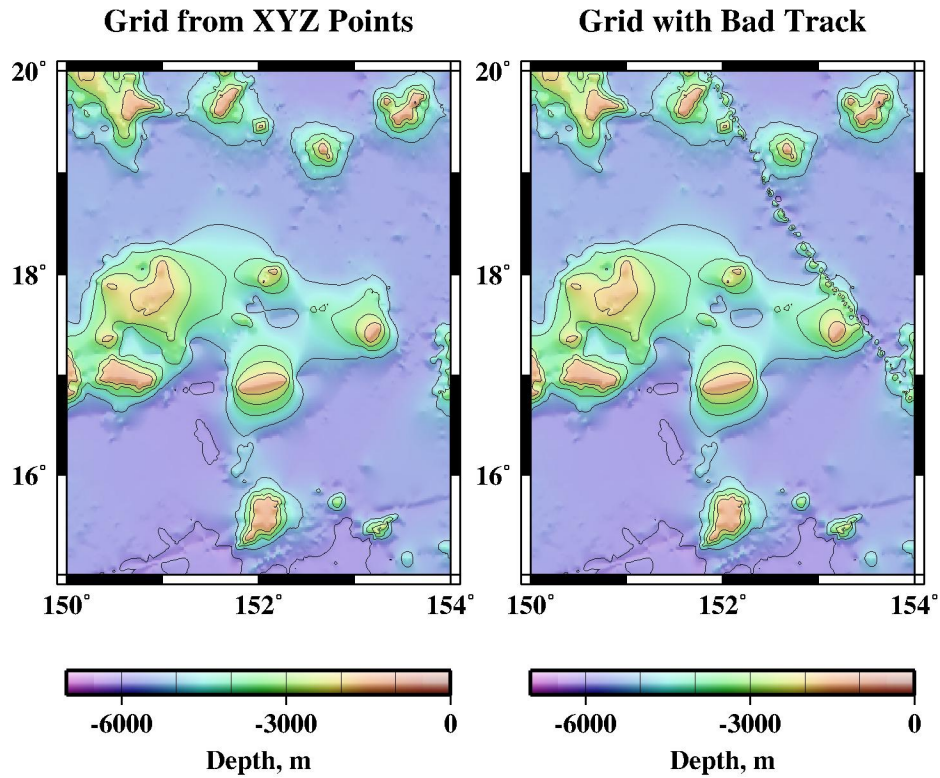

Figure 2.14 Grid of XYZ data points (left), and grid of same XYZ data points with “bad track” included (right).

In the right panel of Fig. 2.14, the bad track stands out as a line of local shallow seafloor anomalies. Contours adjacent to the line are contorted and jagged. Sometimes a bad track or other data with errors can be easy to find as in this demonstration, but they can also be subtle. It is important to use data that are as clean and free of errors as possible.

2.2 Gridding XYZ Data with ArcMap

*Contributed by Anastasia Abramova, Geological Institute Russian Academy of Sciences, Russia
Updated by Karolina Chorzewska, University of New Hampshire, USA*

Here we present step by step example on how to open .xyz space delimited column data in ArcMap and to interpolate data points into a grid of appropriate resolution. As an example ngdc.topo.xyz file (See Section 2.1.1) in geographic coordinate system is used. We would like to create a grid in UTM projection with appropriate cell resolution using Inverse Distance Weighting Interpolation algorithm. The procedure of reprojecting the data, assessing the data density to choose suitable grid size is described. Tools available in ArcMap in order to select optimal interpolation parameters and to compare resultant surface with original data points are discussed. In order to be able to carry out above noted you will need to have Spatial Analyst and Geostatistical Analyst extensions.

2.2.1 Importing XYZ file in ArcMap

In order to open ngdc.topo.xyz file in Arc, you need to modify it: text file needs to have header, data should be comma separated and file name should not have spaces in it.

In order to modify ngdc.topo.xyz text file, import it into MS Excel:

- File>Open
ngdc.topo.xyz
- Select Delimited, press
Next

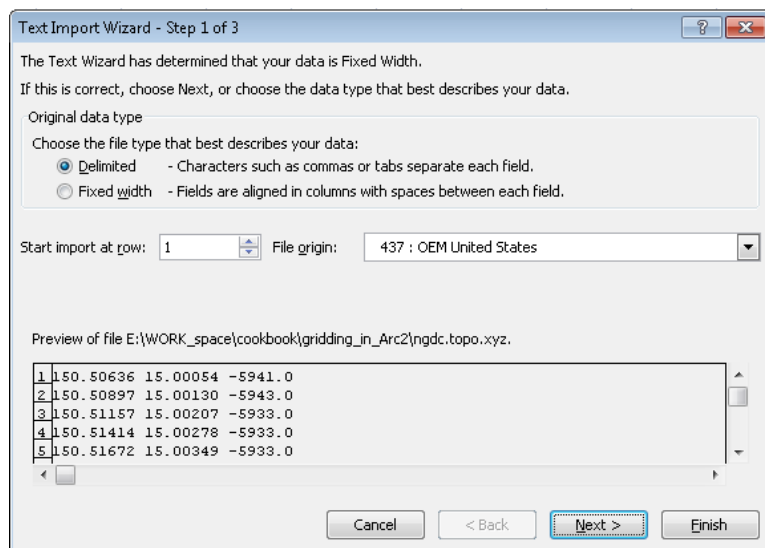

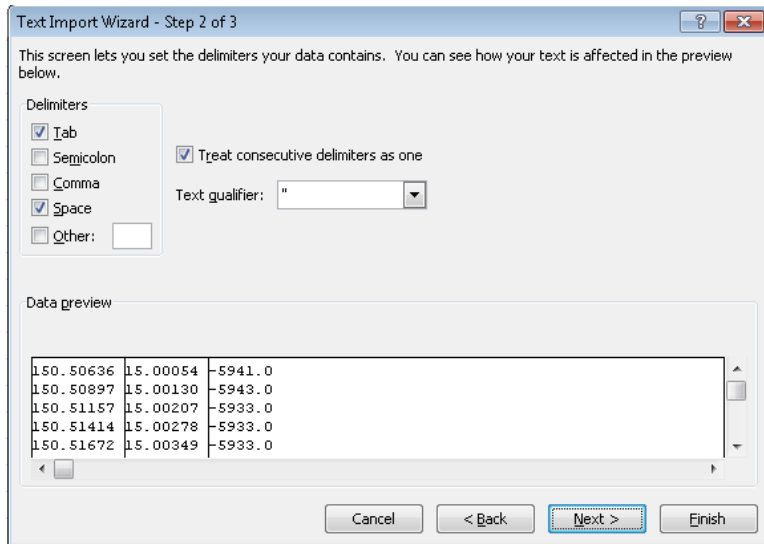

- Insert header row, type header name for each column (no spaces!)

	A	B	C	D
1	Longitude	Latitude	Depth	
2	150.5064	15.00054	-5941	
3	150.509	15.0013	-5943	
4	150.5116	15.00207	-5933	
5	150.5141	15.00278	-5933	
6	150.5167	15.00349	-5933	
7	150.5193	15.0042	-5935	
8	150.5218	15.00492	-5941	
9	150.5244	15.00562	-5934	
10	150.527	15.00633	-5931	
11	150.5307	15.00701	-5926	

- Make sure that the cells that contain numbers are formatted as Numbers in MS Excel
- File> Save as ngdc_topo.dbf (*.dbf) (or *.xls will work too)
- Close file In MS Excel! (Arc doesn't want to open it if it is opened somewhere else)

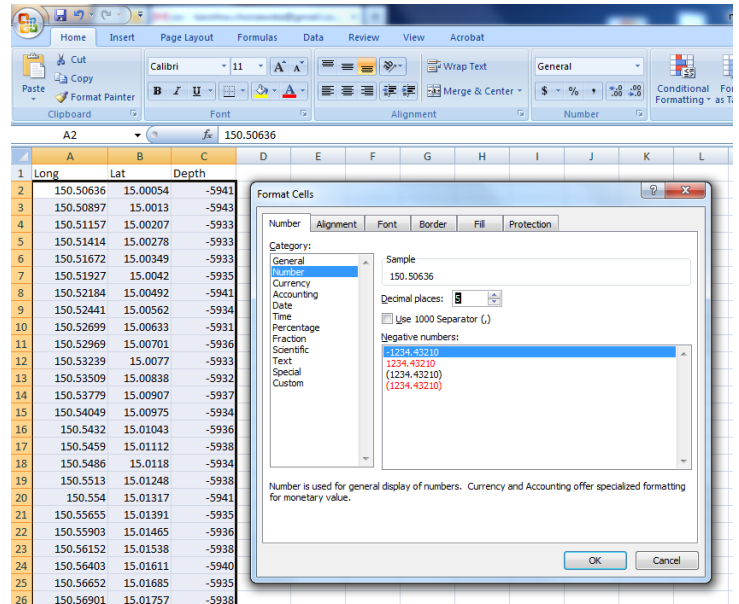

- Open ArcMap: File> New > Blank Document
- Go to Tools> Add XY data and add ngdc_topo.dbf file
- Select the appropriate fields: X as Latitude and Y as Longitude. In order to define the input data projection: press Edit > Select> Geographic> World > WGS 1984. Press Ok

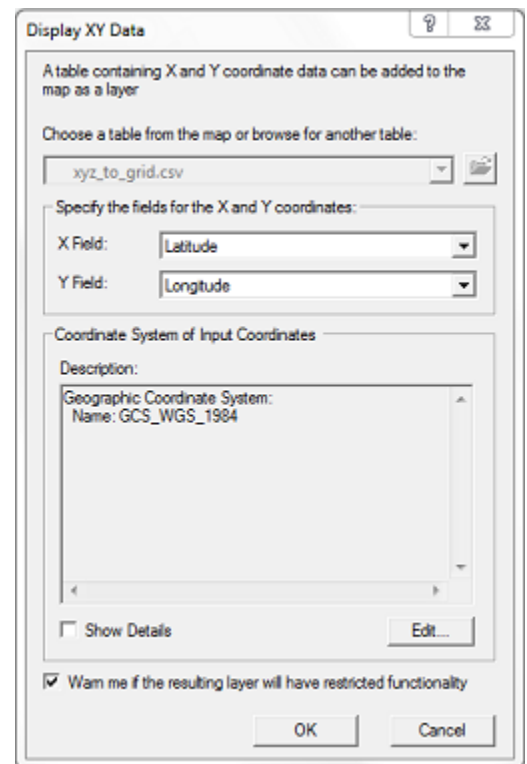

- Now we need to save file as ArcMap shape file, right click on the Layer> Data> Export Data> Save as ngdc_topo.shp file (this is the file we will be working with further on)

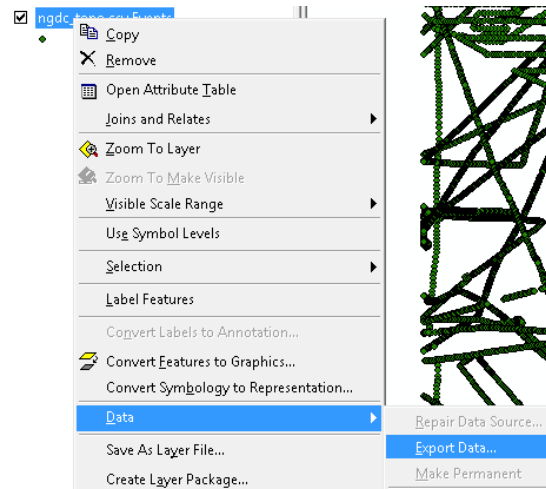

2.2.2 Reprojecting the data

- We would like to create a grid in UTM projection with units in meters, instead of degrees. For that we need to reproject our data.
- Click on Show/Hide ArcToolbox:

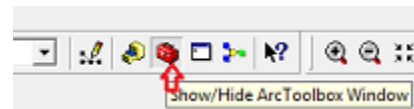

- In opened ArcToolbox choose Data Management Tools> Projections and Transformations> Feature> Project

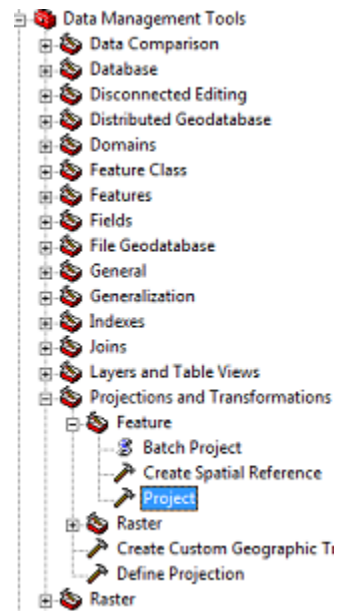

- Define the Input and Output files (ngdc_tpo_UTM.shp) and Output Coordinate System. In our case it is Projected Coordinate System>UTM>WGS1984>UTM_Zone_56N). Press Ok

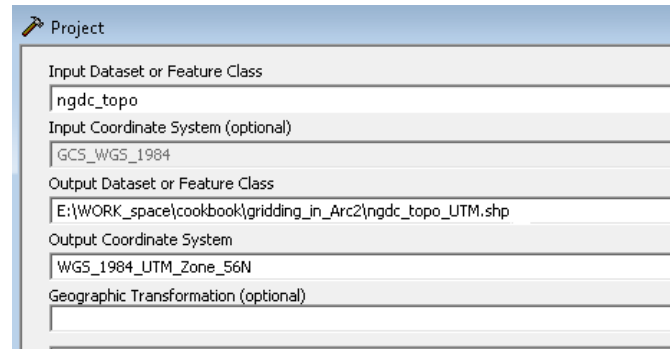

- You might want to change the data frame projection view from Geographic to UTM_Zone_56N now (projection in the data frame view is defined by projection of the first opened file). Right click on Layers> Properties> Coordinate Systems. Select from Predefined list Projected> UTM> WGS 1984> UTM Zone 56N. Press Ok. Now data frame view has the same projection as reprojected file.

- Finally our added data looks like this. As you can notice, the data point density varies over the area

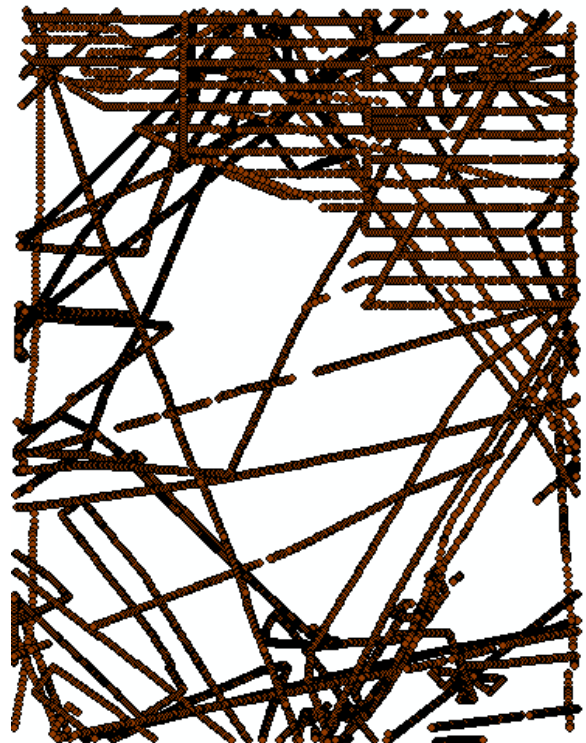

2.2.3 Defining cell resolution for the grid

- The choice of grid resolution depends on your purpose. Meanwhile, data distribution, density, complexity of modeled terrain and scale of the final map should be taken into account as well.
- We would like to create grid with 2 km cell resolution. Here we show how to identify the percentage of cells which values will be defined by interpolation and how to estimate the data density within each cell for the chosen grid size.
- Make sure that Spatial Analyst Extension is activated: go to Tools> Extensions> check Spatial Analyst. Also, add Spatial Analyst toolbar: go to View> Toolbars> check Spatial Analyst.
- From Spatial Analyst toolbar select Convert> Features to Raster

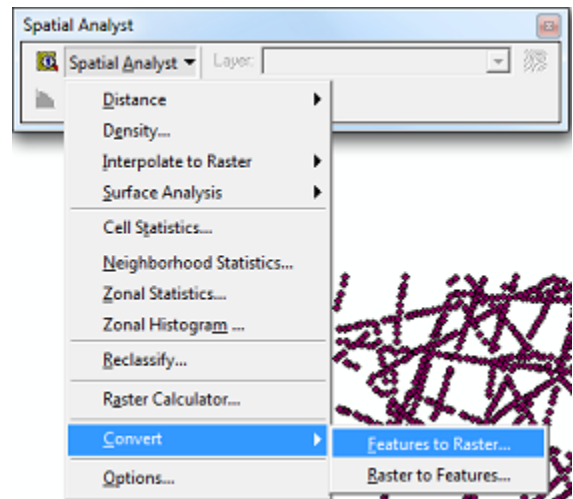

- Select appropriate field and cell resolution:

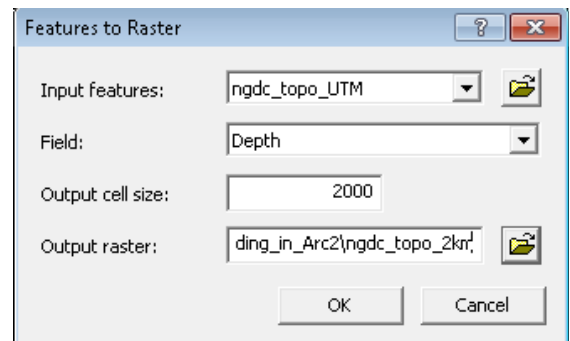

- As you can see, in the created raster (ngdc_topo_2km), only cells with data points in it have non zero values:

Layers

- ngdc_topo_UTM
- ngdc_topo
- ngdc_topo_2km

<VALUE>

- 6,223 - -5,664.111111
- 5,664.111111 - -5,105.222222
- 5,105.222221 - -4,546.333333
- 4,546.333332 - -3,987.444444
- 3,987.444443 - -3,428.555556
- 3,428.555555 - -2,869.666667
- 2,869.666666 - -2,310.777778
- 2,310.777777 - -1,751.888889
- 1,751.888888 - -1,193

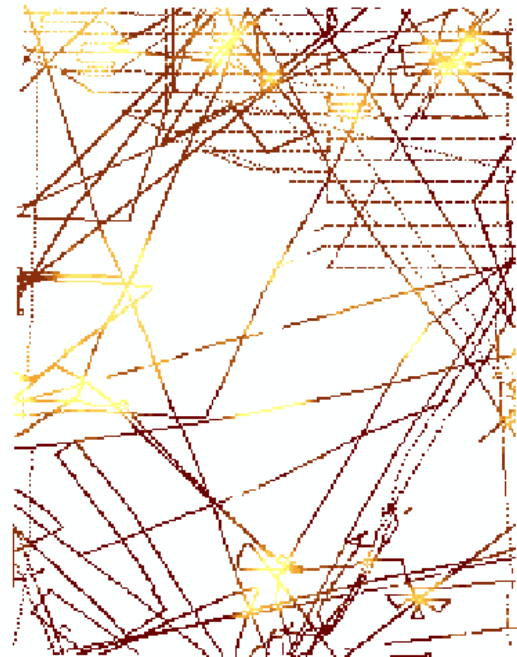

- In order to find out what is the percentage of cells with “no data values”, go to Layer> Properties> Source. Here you can look up the total number of cells in the grid created by multiplying total number of rows by number of columns ($216 \times 279 = 60264$)

Property	Value
<input type="checkbox"/> Raster Information	
Columns and Rows	216, 279
Number of Bands	1
Cellsize (X, Y)	2000, 2000
Uncompressed Size	235.41 KB

- In order to find out how many cells have non zero values, go to Symbology tab in Layer Properties window and click on Classified. Select Classify tab:

Layer Properties

General | Source | Extent | Display | Symbology | Fields | Joins & Relates

Show:

- Unique Values
- Classified**
- Stretched

Draw raster grouping values into classes

Fields

Value: <VALUE>

Normalization: <None>

Classification

Equal Interval

Classes: 9 **Classify...**

Color Ramp:

Symbol	Range	Label
	-6,223 - -5,664.111111	-6,223 - -5,664.111111
	-5,664.111111 - -5,105.222222	-5,664.111111 - -5,105.222222

- The classification table will appear. In Classification Statistics Window, Count will tell the amount of non zero cells (8971). This is approximately 14 % of total amount of cells. Therefore, the values for 86% of cells will have to be estimated by interpolation at chosen resolution of 2 km:

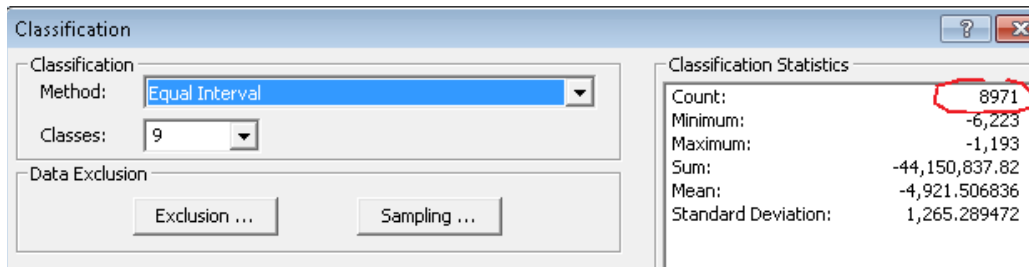

- The density of data points per cell for the chosen grid size should be checked. Number of data points per one cell depends on your purpose.
- Choose Point to Raster tool from ArcToolbox (ArcToolbox → Conversion Tools → To Raster → Point to Raster).

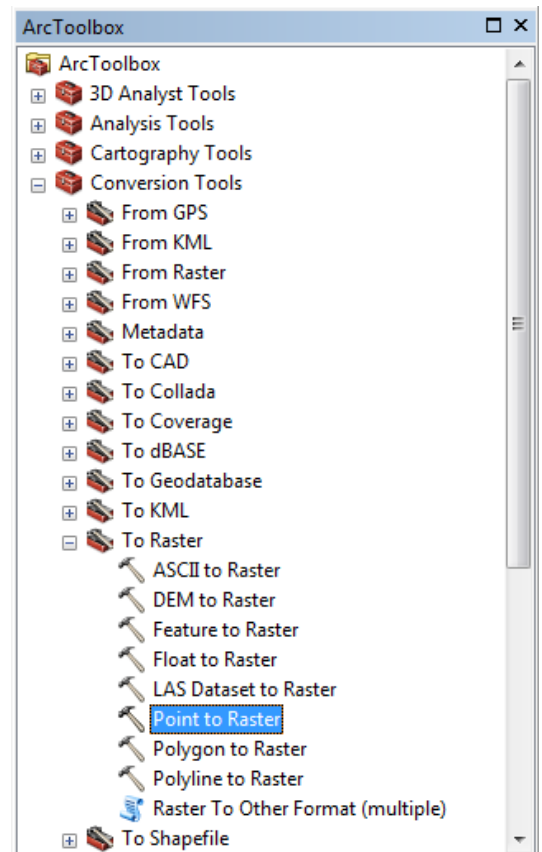

- Use your projected data set as Input Features. Leave default FID in Value field. Choose a name and directory for your output file. Choose COUNT as Cell assignment type. It will assign the number of points within the cell to the output raster's cell. Leave Priority field with NONE and type your gridding cell size in meters in Cellsize box.

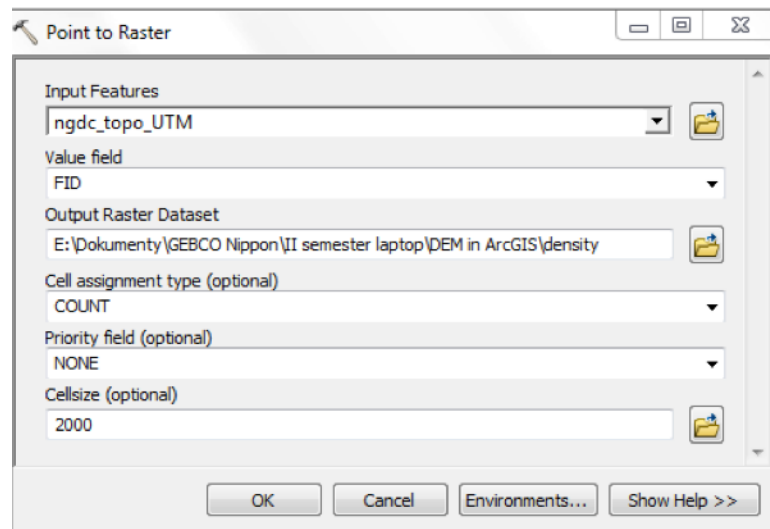

Find more information about Point to Raster tool here:

http://help.arcgis.com/en/arcgisdesktop/10.0/help/index.html#/Point_to_Raster/00120000002z000000/

- This is the result.

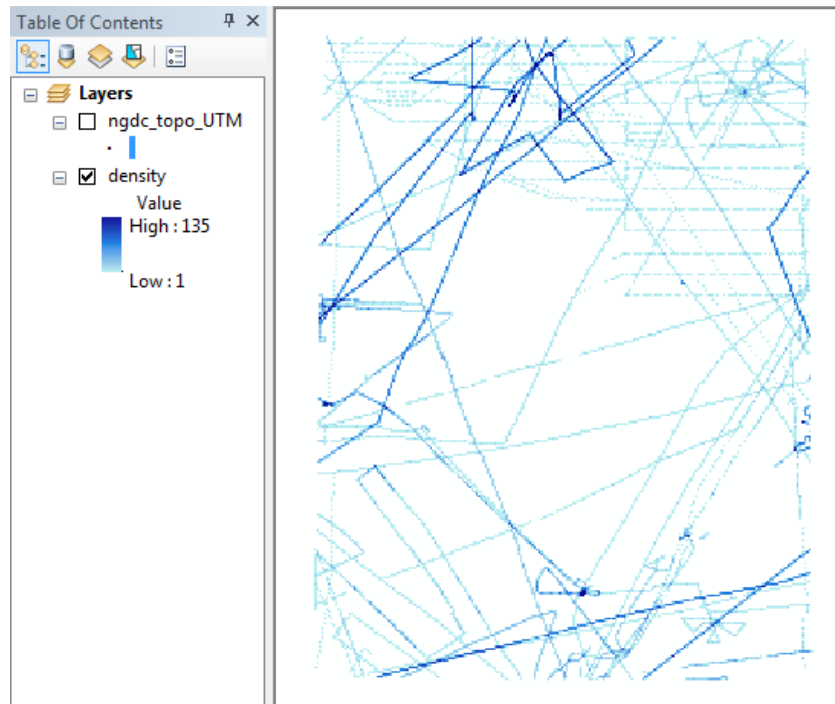

- You can zoom in and check the results of your computations. Shape file with your data points is displayed over the density raster layer. Use the “Identification tool” to click on a cell and check the number of data points within it. It will appear in Identify window under the name of layer and as a Pixel value. Moreover, as a Count value, you have a total number of cells with the same points number as chosen cell.

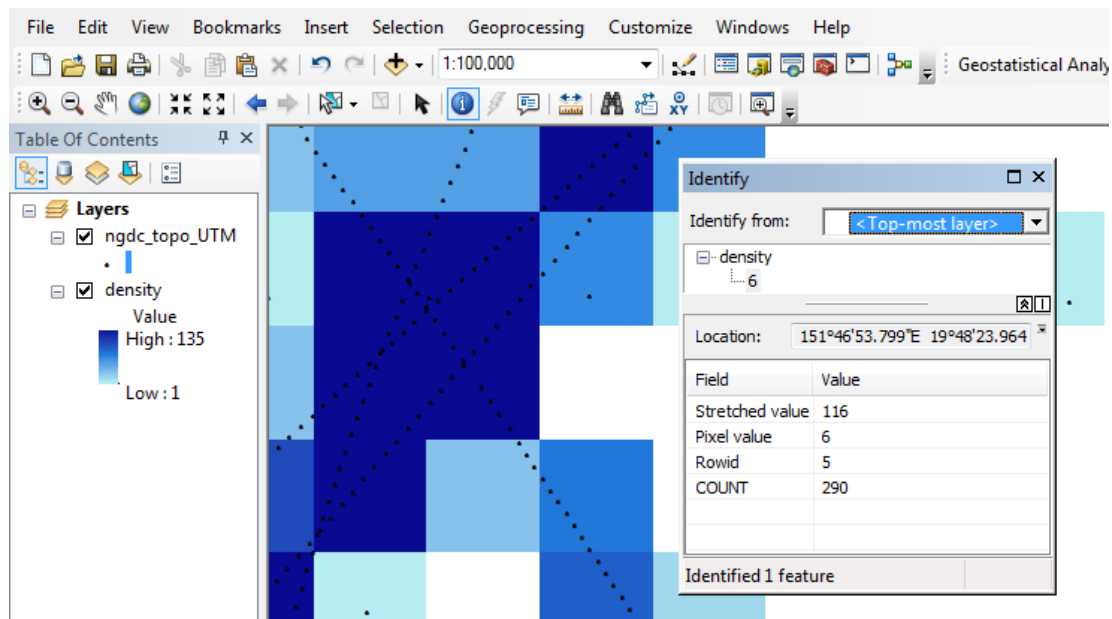

- Maximum density of data points for 2000 m grid size is 135 points. This grid size will be used in the further part of this example, but you may want to change it.

2.2.4 Creating a gridded surface

- There are several interpolation algorithms available in ArcMap, these include Global and Local Polynomials, Kriging, Spline, Natural Neighbor and Inverse Distance Weighting available within Spatial Analyst and 3D extensions. The description of some of these interpolation algorithms can be found in Chapter 8.0. More information on interpolation from point to surface methods can be found:

http://webhelp.esri.com/arcgisdesktop/9.2/index.cfm?TopicName=An_overview_of_the_Raster_Interpolation_toolset

A list of interpolation algorithms are available through Spatial Analyst and Geostatistical Analyst toolboxes:

http://help.arcgis.com/en/arcgisdesktop/10.0/help/index.html#/An_introduction_to_interpolation_methods/003100000008000000/

- Here we will present how to create a gridded surface using Inverse Distance Weighting (IDW) algorithm using Geostatistical Analyst.
- IDW can be a good choice for fast interpolation of sparse data. IDW interpolation predicts values at unmeasured locations according to the values from the surrounding data points. Points which are closer to the prediction location have more influence (weight) on prediction than those which are further away. For more information on IDW see:

http://webhelp.esri.com/arcgisdesktop/9.2/index.cfm?id=3304&pid=3302&topicname=How_Inverse_Distance_Weighted_IDW_interpolation_works

- In order to choose optimal parameters for interpolation, you can use Geostatistical Analyst toolbox. Activate the extension through Tools> Extensions> check Geostatistical Analyst. Also add it to your display through View> Toolbars> Geostatistical Analyst.
- Geostatistical Analyst> Geostatistical Wizard provides cross-validation of your model according to parameters chosen. The wizard allows you to manipulate parameters and to look at the output statistics for the created model. For more information see:

http://webhelp.esri.com/arcgisdesktop/9.2/index.cfm?id=3355&pid=3334&topicname=Performing_cross-validation_and_validation

- In Geostatistical Analyst open Geostatistical Wizard. Select our input data point layer ngdc_topo_UTM and Depth as an attribute:

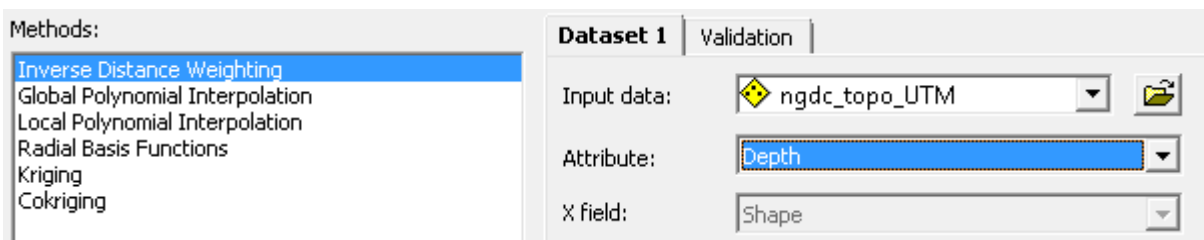

- Click next. In the appeared window select Use Mean> Ok

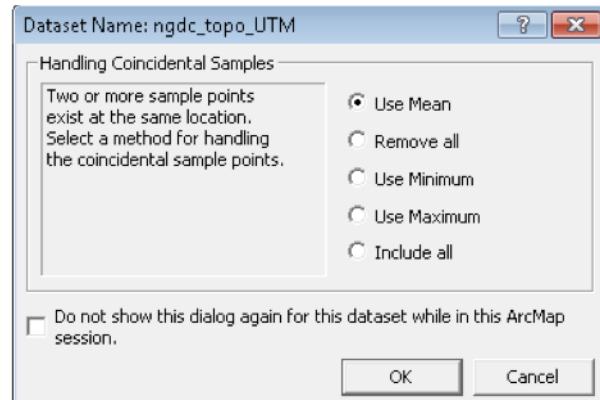

- A set Parameters window will appear. As an example we will use *Neighbors to include* 15, *Include at least* 10, sector type *Four* . After we set the parameters we can click *Optimize power value* button on top left corner. Optimized power will be 4.3. Also you can change the preview type to *Surface*, and while changing the parameters you can see how it will affect the output surface. Click next.

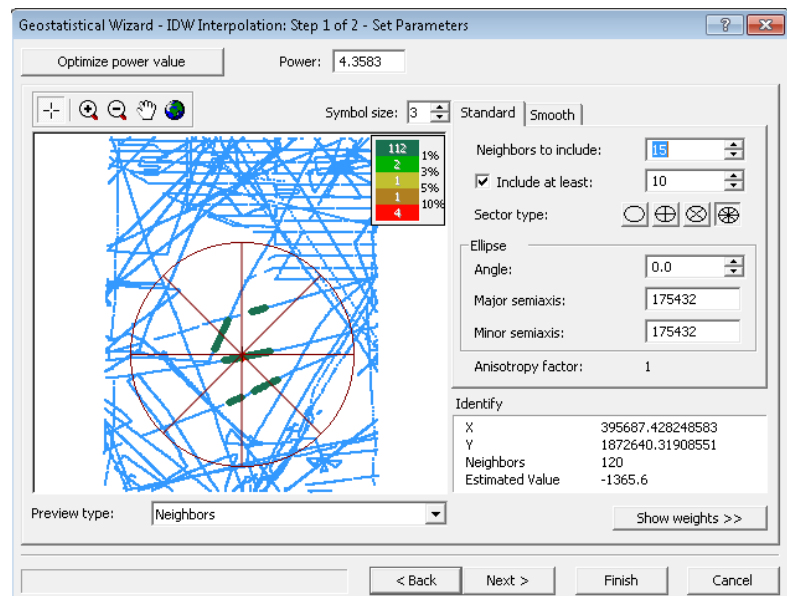

- The window of Cross-Validation will appear. The root mean square error is more than 100 meters. You can vary interpolation parameters and see how they affect on the model fit. Click Finish.

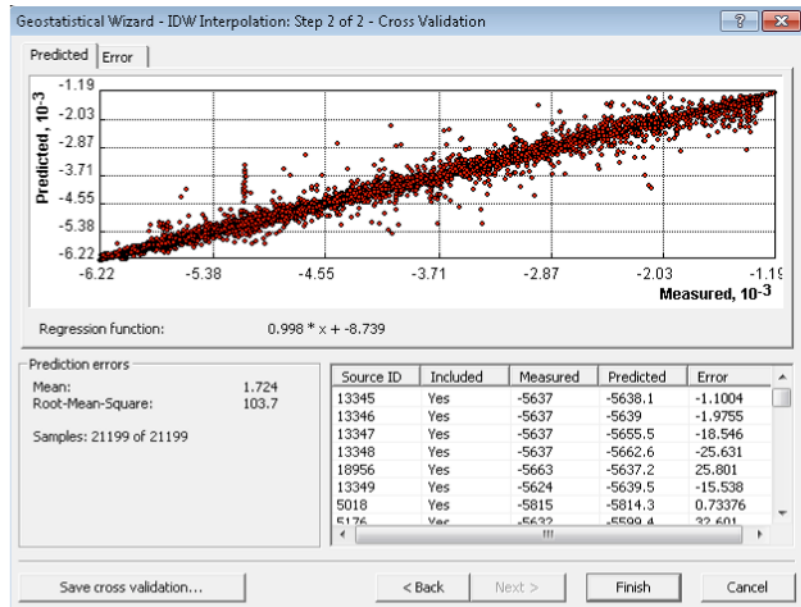

- The summary window will appear. Ok
- The surface is being created
- After adjusting the color bar and checking contours (Layer Properties>Symbology), our final surface using above described parameters looks like that:

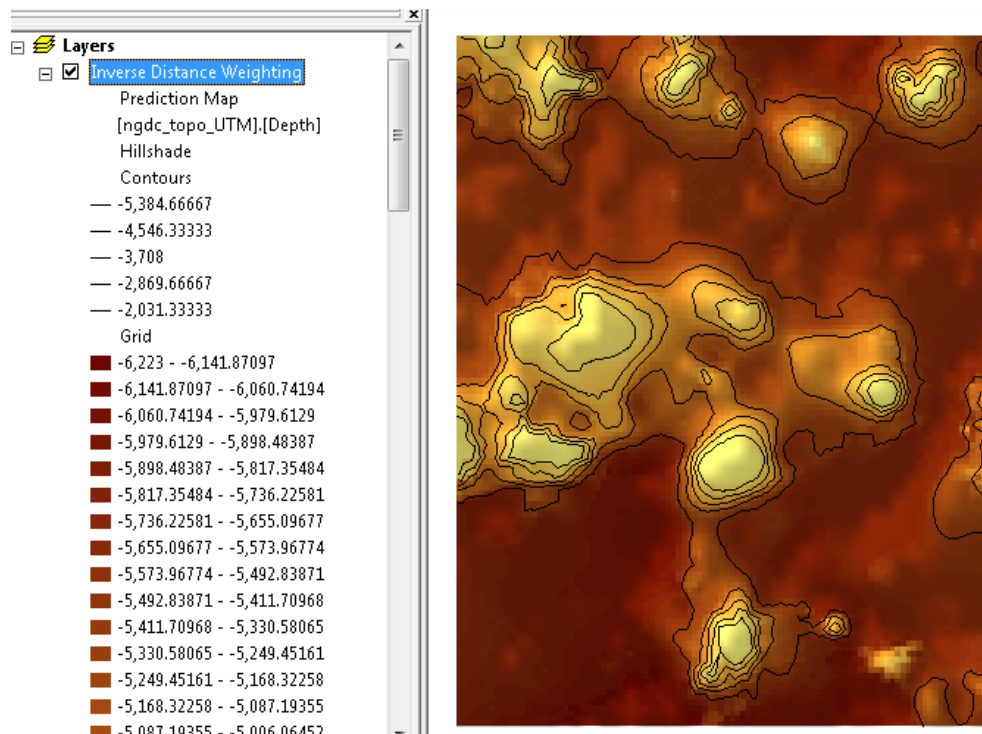

2.2.5 Comparison with original data values

- Here we present how to compare the original data point values with created surface. This could be useful in order to investigate spatial distribution of misfit between model and the measured points. For more information on quality assessment of grids see Chapter 4.1.

- Export our Inverse Distance Weighting layer as ESRI grid: Layer> Data> Export to Raster. Set cell size of 2000. Save as "IDW grid" file name

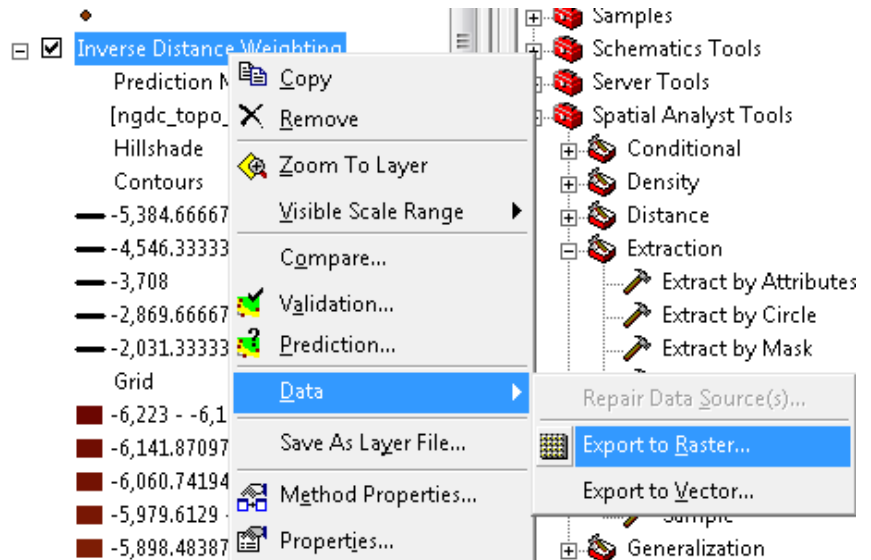

- Now we can extract values from the gridded surface at corresponding original data points with Spatial Analyst Tools> Extraction>Extract Values to Points. Where Input point features is our ngdc_topo_UTM points and Input raster is our IDW grid interpolated raster . OK

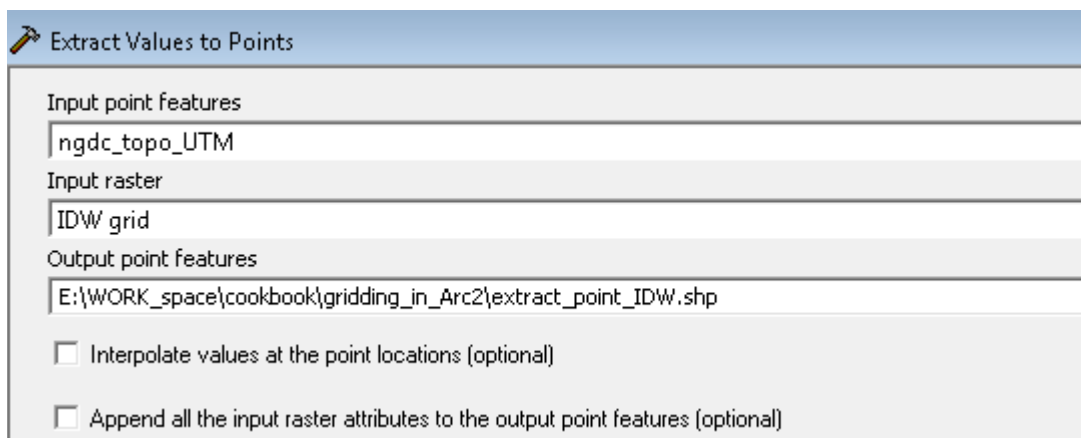

- As a result, a point feature layer is created (we call it extract_point_IDW).

- You can view the Attribute table of the layer by right click on the layer > Open attribute table:

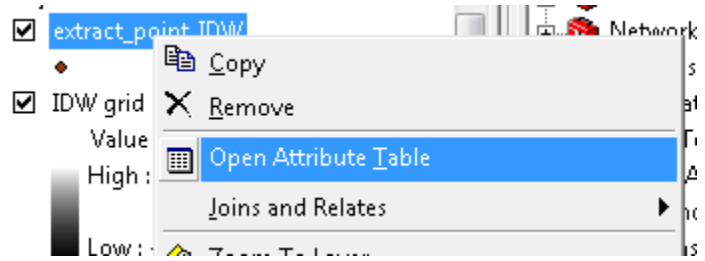

- As you can see from the table it contains information for original data points (x,y,z) and corresponding depth values from our gridded surface (RASTERVALU) for each original data point:

FID	Shape *	LONGITUDE	LATITUDE	DEPTH	RASTERVALU
0	Point	150.50636	15.00054	-5941	-5940.358887
1	Point	150.50897	15.0013	-5943	-5940.358887
2	Point	150.51157	15.00207	-5933	-5935.120605
3	Point	150.51414	15.00278	-5933	-5935.120605
4	Point	150.51672	15.00349	-5933	-5935.120605
5	Point	150.51927	15.0042	-5935	-5935.120605
6	Point	150.52184	15.00492	-5941	-5935.661133
7	Point	150.52441	15.00562	-5934	-5935.661133

- You can calculate differences between these values and visualize them. Go to Options on inside the Attribute table (bottom right corner) and select Add Field option. We will call the new column as “Difference”.

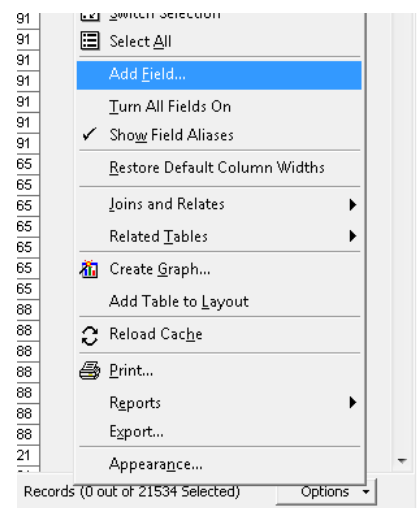

- After the column is created, right click on the header of new created column and select Field Calculator

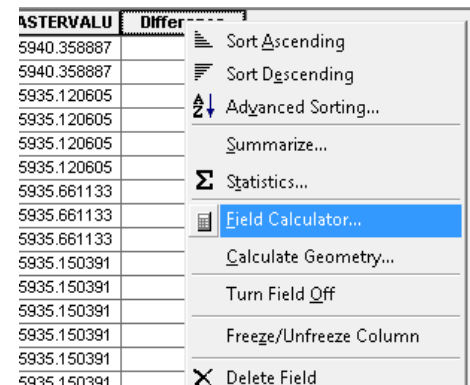

- Inside the Field calculator we can define expression for the new column values: a difference between Depth and RASTERVALUE columns (double click on the Fields to add them to the expression). After clicking Ok, the values are calculated. Close the attribute table

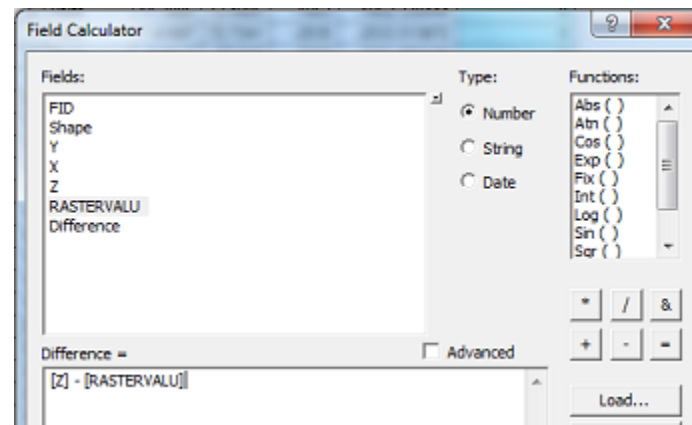

- Now you can visualize the Difference by right clicking on the point layer (Extract_point_IDW)> Properties. Go to Symbology tab. Select Quantities> Graduated colors. Select the Value Fields as Difference, select the color ramp and number of classes, and click Ok.

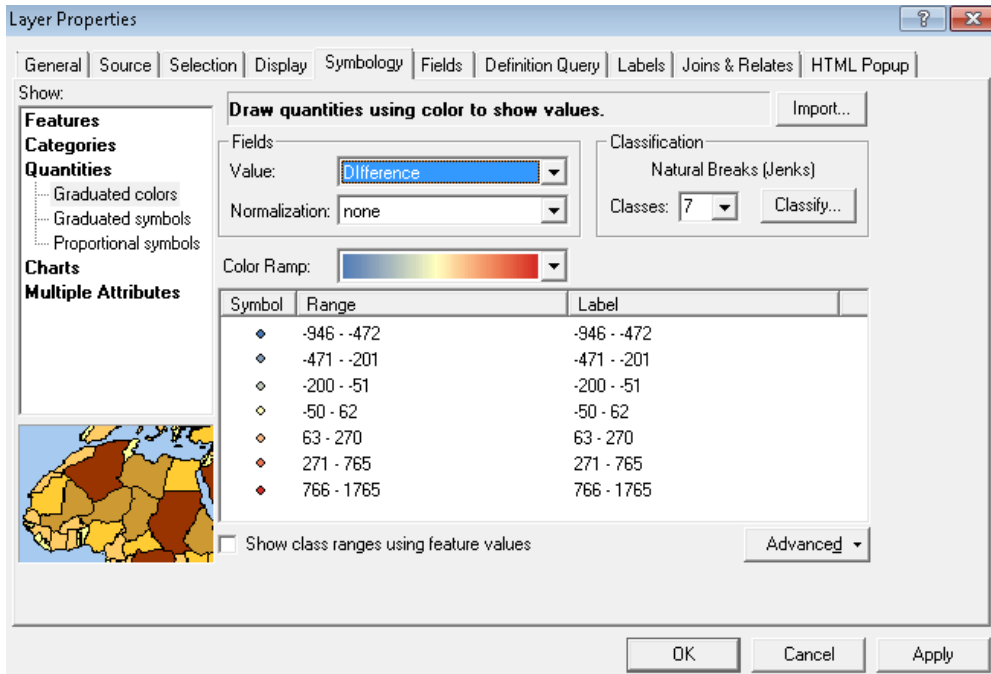

- Now you can see overlaid difference results over the created gridded surface and investigate the regions where differences seem to be significant (make Layers" IDW grid" and "extract_point_IDW " visible):

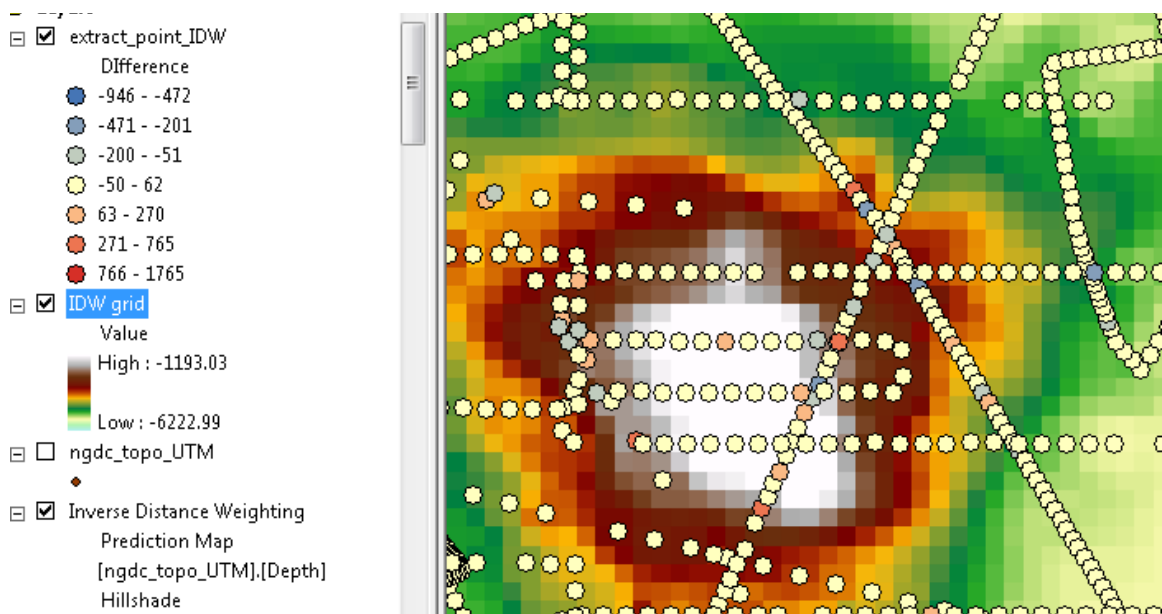

-
- For more information on analyzing gridded surfaces that you create go to:

http://webhelp.esri.com/arcgisdesktop/9.2/index.cfm?TopicName=About_analyzing_raster_data

http://webhelp.esri.com/arcgisdesktop/9.2/index.cfm?id=603&pid=598&topicname=Surface_creation_and_analysis

See more on interpolation error analyses:

http://webhelp.esri.com/arcgisdesktop/9.3/index.cfm?TopicName=About_geoprocessing_with_3D_Analyst

FUNDAMENTALS

Chapter 3.0 Gathering Software

Some software packages are freely available for download from the internet. The purpose of this chapter is to show where to find such software and how to obtain it.

3.1 Generic Mapping Tools

Contributed by K. M. Marks, NOAA Laboratory for Satellite Altimetry, USA

GMT (Generic Mapping Tools) (Wessel and Smith, 1998) is a collection of open source mathematical and mapping routines for use on gridded data sets, data series, and arbitrarily located data. The GMT package is available for download from the University of Hawaii website (<http://gmt.soest.hawaii.edu/>) (see Figure 3.1). We utilized GMT routines for much of our data analyses, gridding, and mapping discussed in selected chapters that follow. Software packages such as MATLAB, IMSL, ArcGIS and others may also provide similar mathematical and mapping capabilities, but these are not free.

THE GENERIC MAPPING TOOLS

What is GMT?

GMT is an open source collection of ~60 tools for manipulating geographic and Cartesian data sets (including filtering, trend fitting, gridding, projecting, etc.) and producing Encapsulated PostScript File (EPS) illustrations ranging from simple x-y plots via contour maps to artificially illuminated surfaces and 3-D perspective views. GMT supports ~30 map projections and transformations and comes with support data such as GSHHS coastlines, rivers, and political boundaries. GMT is developed and maintained by [Paul Wessel](#) and [Walter H.F. Smith](#) with help from [a global set of volunteers](#), and is supported by the [National Science Foundation](#). It is released under the [GNU General Public License](#).

Current version is 4.5.5, Released November 1, 2010. For a peek at the next generation GMT 5, see our [GMT 5 pages](#).

GMT is used all over the world. Each yellow dot represent a 15x15 arc minute block with one or more registered user or institution. So far, almost 2000 such blocks have been registered, representing more than 15,000 individual GMT users. To add your dot, fill out the [registration form](#).

GMT Pages maintained by:
Paul Wessel

Last updated:
November 1, 2010

SCHOOL OF OCEAN AND EARTH SCIENCE AND TECHNOLOGY
UNIVERSITY OF HAWAII AT MANOA

Visit SOEST home page

Figure 3.1 University of Hawaii website for GMT.

To download the GMT software package, click on “download” shown in the left column of the figure above. Instructions for how to obtain and install the GMT software are given on the download webpage (see Figure 3.2).



THE GENERIC MAPPING TOOLS



- HOME
- EXAMPLES
- FAQ
- DOWNLOAD
- DOCS
- MAILINGLISTS
- REGISTRATION
- MIRRORS
- RESOURCES
- BUGS
- ARRRGHH!
- RELEASES

GMT Pages maintained by:
Paul Weszel

Last updated:
November 1, 2010



Visit SOEST home page





Obtaining and Installing GMT

GMT is available via anonymous ftp from a global set of ftp servers, each contain the same files as the main server in Hawaii. File transfer is usually faster if you select the server closest to you. Our installer will automatically get the required archives from the ftp site you choose.
Users with a slow Internet-connection and users who desire large amounts of supplemental data sets ready to be used with GMT: See the GMT Companion DVD-R products distributed by [Geoware](#).

Fast-track for (repeat) UNIX/Linux/OSX users

I've done this before. Take me directly to the [INSTALL FORM](#).

Platform-specific Instructions

1.  **UNIX or LINUX:** Note: The install process requires [bzp2](#).
 1. *Automated install [Recommended].* Obtain and install GMT by interacting with the [INSTALL FORM](#). Follow instructions there to obtain the Bourne shell install-script *and* a customized install parameter file. The automated install will also install `netCDF` if needed.
 2. *Manual install.* If you prefer, you can also do the typical manual install by typing the files, `untar, run configure, make` etc. Read the README file for the required steps. For manual install you must also manually get and install the [Unidata netCDF library](#) which GMT requires, or have the library already installed. Use ftp to any of the GMT [mirror sites](#).
 3. *CVS installation for GMT gurus.* To get the bleeding edge GMT version and even contribute to the development of GMT, consider installing the "live" GMT version by following the [CVS instructions](#).
2.  **WINDOWS:**
 1. *DOS batch files rule.* If you just want to install Windows executables and get on with it, visit our [GMT Windows](#) page for access to Windows Installers. Note that many of the DOS example scripts utilize GNU awk; the WIN32 executable [gawk](#) has therefore been placed on all ftp sites.
 2. *DOS batch files suck, part I.* Because you cannot get much done with DOS batch jobs, we strongly recommend that you install [Cygwin](#), a free UNIX emulation package for Windows. Cygwin lets you open shell windows and access standard UNIX tools such as `test, gcc, etc.` You would then install GMT as described above for UNIX/Linux.
 3. *DOS batch files suck, part II.* If you run Windows, you can get access to `cmd` command windows by installing the freely available Windows [Services for UNIX](#), a UNIX environment for Windows. SFU lets you install GMT as described for UNIX/Linux above.
 4. *DOS batch files suck, part III.* Finally, you may consider the option of running Linux within a virtual machine, such as [VMWare](#) or [VirtualBox](#), and then pursue the general Linux/UNIX install option.
 5. *Cygwin sucks.* Cygwin is painfully slow to run configure scripts and to launch programs (once launched, programs run fast), so actually the best and easiest way of running GMT under Cygwin is to use the Windows native binaries. All it takes for this solution is to install the Windows executables ([GMT Windows](#)) and add the GMT Win bin directory to your Cygwin path via the `bashrc` file.
3.  **OS X:** GMT installs and runs under Apple's OS X which is UNIX-based; just follow instructions for UNIX/Linux above. You must first install the Xcode Developer Tools (which includes the GNU C compiler, `make`, etc) as these are not installed by default but is an optional install via the OS X Install DVD. You can also download them from Apple's support site. Also select to install X11. Finally, the latest versions of GMT are also available as user-friendly [packages](#) via [Fink](#).
4.  **OS/2:** GMT has been ported to OS/2. For information and precompiled executables, see Allen Cogbill's [GMT OS/2 page](#).

Obtaining the old GMT 3.4.6 version

If you for whatever reason need to install the final version of the GMT 3 series you must manually ftp the tar-balls from [SOEST's GMT3 archive](#) and run the installation (follow the steps in the README file).

Figure 3.2 GMT download and installation web page.

Chapter 4.0 Software Overview

The purpose of this chapter is to give an overview of various software packages that can be used to clean, process, manipulate, analyze, and plot data used in scientific research and production.

4.1 ArcGIS

Contributed by Pauline Weatherall, British Oceanographic Data Centre (BODC), UK

The software company, ESRI (www.esri.com), produces a range of Geographic Information System (GIS) products suitable for accessing, processing, sharing and serving geo-referenced data, working both in a MS Windows environment and also via the internet.

Further information about ESRI's products; accessible data sets; development tools; specialized applications and open source products can be found on ESRI's web site:

<http://www.esri.com/products/index.html>

The information below aims to give a very broad overview of some of the functionality of **ArcGIS for Desktop software**, specifically in relation to GEBCO's work with building gridded bathymetric data sets. The information and links below relate to ArcGIS Desktop version 10.

4.1.1 What is ArcGIS for Desktop Software?

ArcGIS for Desktop is ESRI's MS Windows-based GIS software. As part of its functionality, the software can be used to:

- View, overlay, manage, edit, analyse and capture geo-referenced data
- Produce and share maps, data and imagery
- Grid data
- Search for data and imagery
- Carry out datum and projection transformations
- Edit/develop metadata

4.1.2 Is the software free, what licences are available and how can you access the software?

ESRI makes available a range of desktop software products, some are available free of charge and some are available commercially at a number of **licensing levels**. The functionality of the software depends on the licensing level and is also reflected in the price of the software.

Further details about software access and licensing for each product can be found on ESRI's web site:

http://www.esri.com/products/index.html#desktop_gis_panel

4.1.3 What type of computer platform does it run on?

ArcGIS for Desktop products are designed for use in a MS Windows environment. Details about supported operating systems and hardware and software requirements can be found on ESRI's web site:

<http://www.esri.com/software/arcgis/arcgis-for-desktop/system-requirements>

4.1.4 What does the software do?

As outlined above, the software can be used to visualise, edit, capture, process, share and analyse geo-referenced data.

Firstly, we need to look at what the various component packages of the ArcGIS Desktop products do and what types of data and data formats they can work with. The following is a broad overview of their functionality, further information can be found in the products' documentation.

ArcGIS for Desktop application packages - what are they and what do they do?

ArcMap is used for creating, displaying, exploring, analysing and editing your data; assigning styling to the display and for building images and map layouts from individual data layers or data sets.

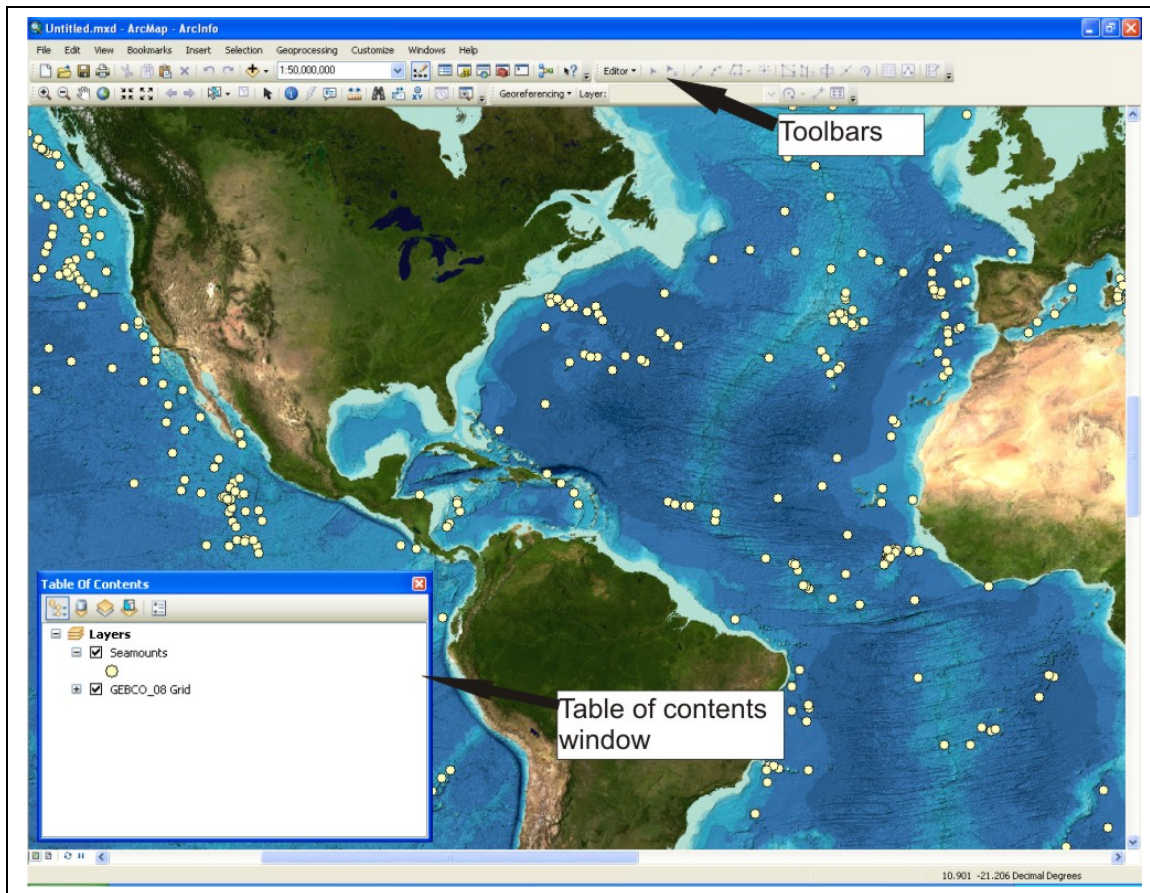

Displaying information from GEBCO's data sets in ArcMap – a Tiff image overlain by a shapefile of point data

An introduction to ArcMap:

<http://help.arcgis.com/en/arcgisdesktop/10.0/help/index.html#//006600000001000000.htm>

A quick tour of ArcMap:

http://help.arcgis.com/en/arcgisdesktop/10.0/help/index.html#/A_quick_tour_of_ArcMap/0066000033200000/

ArcCatalog lets you organise, preview and manage your data sets. In simple terms it can be thought of as acting a little like MS Windows Explorer in that it provides an overview of the contents of the directories on your PC. However, it displays the information in a form that is useful for working with ESRI software, i.e. although a shapefile is made up of at least three separate files when viewed with Windows Explorer, within ArcCatalog it is just represented as one file. ArcCatalog also lets you view and enter metadata for your data sets in a number of standard formats. A catalog window is available in ArcMap to let you manage your data sets.

<http://help.arcgis.com/en/arcgisdesktop/10.0/help/index.html#//006m00000069000000.htm>

ArcToolbox is a collection of data processing tools collected into related ‘toolboxes’ and ‘toolsets’. They have a wide range of functionality, including data analysis and conversion tools. The availability of the various toolboxes and toolsets depends on the level of your ArcGIS Desktop license.

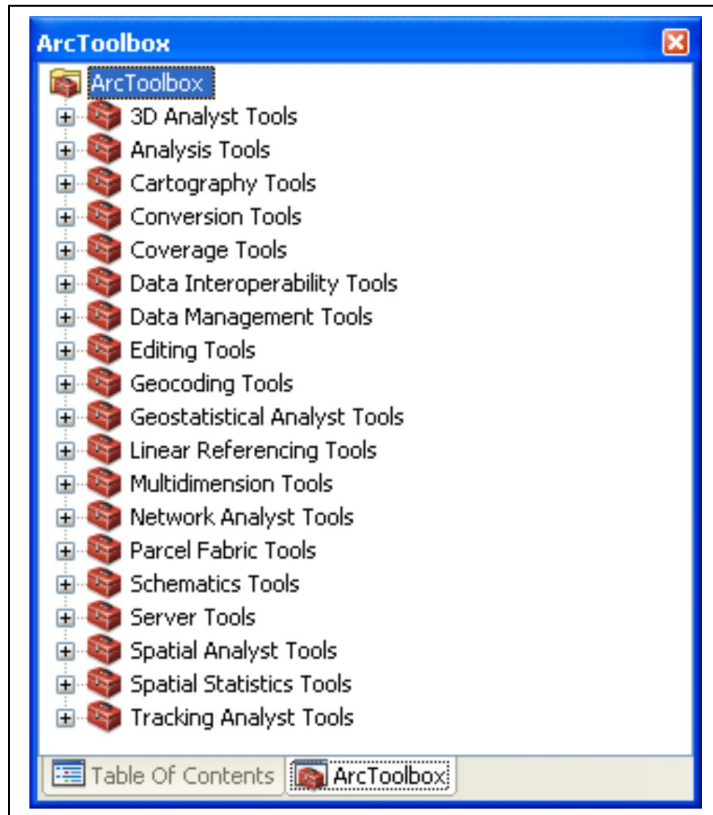

Some of the Tool sets available through ArcToolbox

A quick tour of geoprocessing tools:

http://help.arcgis.com/en/arcgisdesktop/10.0/help/index.html#/A_quick_tour_of_geoprocessing/02s00000002000000/

Information on finding tools can be found at:

http://help.arcgis.com/en/arcgisdesktop/10.0/help/index.html#/A_quick_tour_of_finding_tools/02400000001000000/

The packages, **ArcScene** and **ArcGlobe** are part of the 3D Analyst extension package and can be used to view data in 3D and produce and animations (ArcScene) and display data on a globe (ArcGlobe).

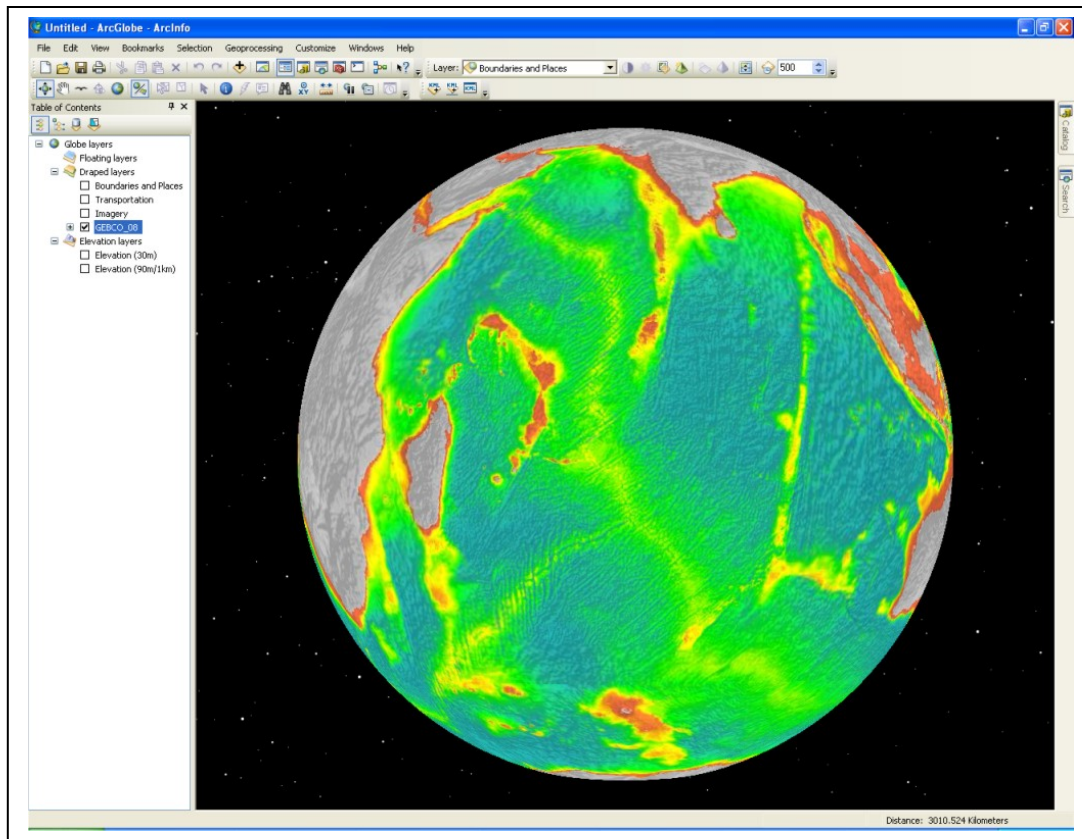

Displaying the GEBCO Grid in ArcGlobe

Further information about extension packages can be found on ESRI's web site:

<http://www.esri.com/software/arcgis/arcgis-for-desktop/extensions.html>

In what formats and structures does ESRI ArcGIS Desktop software store data?

ESRI ArcGIS Desktop software works with and stores data in a number of ways, as individual data files or as collections of related data files. The data sets may be stored individually on disc or be part of a database. The data sets can be in the form of 3D surfaces (e.g. rasters), vectors (e.g. points, lines or polygons) or images.

The following outlines the main data storage types used by ESRI's ArcGIS Desktop software products.

Geodatabase

This is the main data model for ArcGIS and is the primary data format used for editing and data management. It is made up of a collection of files (feature classes, raster data sets and tables).

Feature classes are collections of features of the same type, such as points, lines or polygons. They also share a common set of attribute fields. Within a Geodatabase they can be grouped into

feature data sets which are collections of feature classes with the same geographic reference information (i.e. datum and projection).

Geodatabases work across a range of database management system (DBMS) architectures and file systems, can be of various sizes, and be single or multi-user.

Within some ArcDesktop GIS packages, storing your data in a geodatabase allows you to carry out advance editing and quality control procedures on vector data sets, i.e. looking at how the vector data sets which make up the geodatabase ‘interact’ or share geometry – this is called topology. For example making sure the outlines of individual polygons do not overlap. This functionality is not available for shapefiles.

Further information about geodatabases can be found on ESRI’s web site:

<http://help.arcgis.com/en/arcgisdesktop/10.0/help/index.html#//003n00000002000000>

Shapefiles

The Shapefile is a format that ESRI software uses to store the shape, geometric location and attribute information about a data set. Individual shapefiles can contain only one feature ‘type’, i.e. points, lines or polygons. Shapefiles can be edited but they cannot be used as part of a topology for more advanced quality control procedures.

Further information about shapefiles can be found on ESRI’s web site:

http://downloads2.esri.com/support/whitepapers/mo_/shapefile.pdf

3D Surfaces

ESRI products work with the concept of three types of surface models:

- **Rasters** – rectangular array of grid cells (holding a data value) arranged in rows and columns
- **Triangular Irregular Networks (TINs)** - a surface consisting of nodes (or points) joined by edges into various sizes of triangles. Because the nodes can be irregularly spaced, a TIN can show higher resolution information where there is more variation in terrain and be lower resolution where there is less variation.
- **Terrain surfaces** – are a set of ‘pyramided’ TINs, i.e. a set of TIN’s at multiple levels of resolution. This helps when working with high volume data sets.

Find out more about how ArcGIS software works with 3D surfaces:

http://help.arcgis.com/en/arcgisdesktop/10.0/help/index.html#Fundamentals_of_Surfaces/00q8000005z000000/

<http://help.arcgis.com/en/arcgisdesktop/10.0/help/index.html#//00q8000000rm000000>

How do you work with your data in ArcGIS Desktop packages – do you have to reformat it?

As described above, ArcGIS Desktop packages work with data in a number of forms, as individual ‘stand-alone’ files or as part of a geodatabase.

Data in some formats can be imported or used directly with ArcGIS Desktop applications, others need to be converted to ESRI formats.

Information about supported data formats for import and export can be found on ESRI’s web site:

<http://help.arcgis.com/en/arcgisdesktop/10.0/help/index.html#//009t00000000q000000>

Through the **ArcGIS Data Interoperability Extension** tool set, data can be imported, exported and converted to a number of formats. Further information can be found at:

<http://www.esri.com/software/arcgis/extensions/datainteroperability/index.html>

Further information about importing data is given below:

http://help.arcgis.com/en/arcgisdesktop/10.0/help/index.html#//An_overview_of_the_To_Raster_toolset/00120000002r000000/

In addition to creating rasters from input point data sets, you can also create rasters from polyline and polygon data sets. Further information is available at the above link.

Connecting to Open Geospatial Consortium (OGC) Web Services

You can connect directly to Web Map Services (WMS), Web Coverage Services (WCS) and Web Feature Services (WFS). Further information can be found on ESRI’s web site:

<http://help.arcgis.com/en/arcgisdesktop/10.0/help/index.html#//0037000000002000000.htm>

Working with KML files

Information on working with KML files can be found on ESRI’s web site at:

<http://help.arcgis.com/en/arcgisdesktop/10.0/help/index.html#//00s200000000m000000.htm>

Adding X Y data

Point data, in ASCII format, can be imported into ArcMap as a layer using the **Add XY** option, attribute information can also be imported along with the data. The data can then be exported as a shapefile or feature class.

Working with netCDF files

Grid files, in 2D netCDF form, can be imported into ArcMap as a ‘netCDF raster layer’ through the ‘Make NetCDF Raster Layer’ Multidimension Tools set in ArcToolbox. Further details can be found on ESRI’s web site:

<http://help.arcgis.com/en/arcgisdesktop/10.0/help/index.html#//004300000006000000.htm>

Additional tools for data import

There are ‘add on’ tools such as ETGeowizards (http://www.ian-ko.com/ET_GeoWizards/gw_main.htm) which can be used to help with the import and export of vector and raster data sets for use with ArcMap.

Can you create a 3D surface from your source data sets?

The following outlines how you can use ESRI’s software to create a raster or Triangular Irregular Networks (TIN) from your input data.

Creating a raster from point data

As part of the ArcGIS 3D Analyst extension software package you can create a raster from a data set of points using a number of interpolation methods:

- Inverse distance weighted
- Spline
- Kriging
- Natural neighbours

Further information about creating rasters can be found in the ArcGIS 3D Analyst product documentation, available from ESRI’s web site:

<http://help.arcgis.com/en/arcgisdesktop/10.0/help/index.html#//00q900000034000000>

Further information about gridding using ESRI software can be found in the section 8.2.10 of this document, ‘Gridding with ArcMap’.

Working with raster surfaces

The following are examples of some simple tasks that you may want to carry out, for the full range of functionality see the ArcGIS Desktop documentation.

Analysing surfaces and generating contours

You can analyse the surface of your 3D model, looking at slope and aspect and hill shade and also **generate contours** at specified intervals. This can be done through the 3D Analyst extension – which provides a set of tools for working with rasters, TINs and terrain surfaces. Further information is given in the documentation.

http://help.arcgis.com/en/arcgisdesktop/10.0/help/index.html#/An_overview_of_the_3D_Analyst_toolbox/00q900000070000000/

The Spatial Analyst extension provides a set of tools for working with and analysing both raster and vector data sets.

http://help.arcgis.com/en/arcgisdesktop/10.0/help/index.html#/An_overview_of_the_Spatial_Analyst_toolbox/009z00000003000000/

Raster calculations

You can carry out mathematical operations on cells in a raster. This includes carrying out calculations on grid cells such as add, subtract or divide. This can be done by either adding or subtracting one grid from another or by adding or subtracting single values for each grid cell.

The following table lists the available toolsets and gives a brief description of each:

http://help.arcgis.com/en/arcgisdesktop/10.0/help/index.html#/An_overview_of_the_Raster_Math_toolset/00q900000063000000/

Extracting data from rasters

You can extract data from rasters either based on geographic area ‘clipping’ or by cell values (attributes). For example, you may select a geographic sub-area from a grid or select cells from a grid with a depth greater than say 100m.

The majority of the extraction tools are available with the **Spatial Analyst Extension**; however, the ‘Clip’ tool is available with any ArcGIS license.

Further information about the ‘Clip’ tool can be found at:

<http://help.arcgis.com/en/arcgisdesktop/10.0/help/index.html///00170000009n000000>

For information about data extraction as part of the spatial analyst extension see:

http://help.arcgis.com/en/arcgisdesktop/10.0/help/index.html#/An_overview_of_the_Extraction_tools/009z00000028000000/

Resampling, generalising and filtering rasters

A set of resampling, generalisation and filtering tools is provided as part of the ArcGIS Desktop products.

Resampling a raster, i.e. changing the size of the grid cells can be done through the ‘resample’ tool, part of the Data Management Toolbox:

<http://help.arcgis.com/en/arcgisdesktop/10.0/help/index.html#/Resample/00170000009t000000/>

The ArcGIS Spatial Analyst extension contains a number of tools for generalising and filtering rasters:

http://help.arcgis.com/en/arcgisdesktop/10.0/help/index.html#/An_overview_of_the_Generalization_tools/009z00000033000000/

Working with your data in ArcMap

ArcMap is the ArcGIS Desktop package which can be used to view and edit your data sets in 2D.

Further information can be found on ESRI’s web site:

<http://help.arcgis.com/en/arcgisdesktop/10.0/help/index.html#//006600000001000000.htm>

A quick tour of the functionality of ArcMap is given at the following link:

http://help.arcgis.com/en/arcgisdesktop/10.0/help/index.html#/A_quick_tour_of_ArcMap/006600000332000000/

The following are examples of some of simple functions that you might want to do in ArcMap.

To view a data set, it needs to be in a format which can be recognised by ESRI ArcGIS Desktop software (see above for more information). Click on the ‘Add Data’ button from the ArcMap toolbar, then search your data directories to select the file that you want to load.

http://help.arcgis.com/en/arcgisdesktop/10.0/help/index.html#/Adding_layers_to_a_map/0066000000t0000000/

In version 10 of ArcGIS Desktop you can also search for GIS content in your own file system and on the internet:

http://help.arcgis.com/en/arcgisdesktop/10.0/help/index.html#/Using_search_in_ArcGIS/00660000007q000000/

Once a data set is loaded you can experiment with changing how the displayed layer looks, for example, altering the colours or symbols used to display the data and adding label and text information. This can help to highlight aspects of the data set that you want to enhance, e.g. displaying data in a particular depth range all one colour.

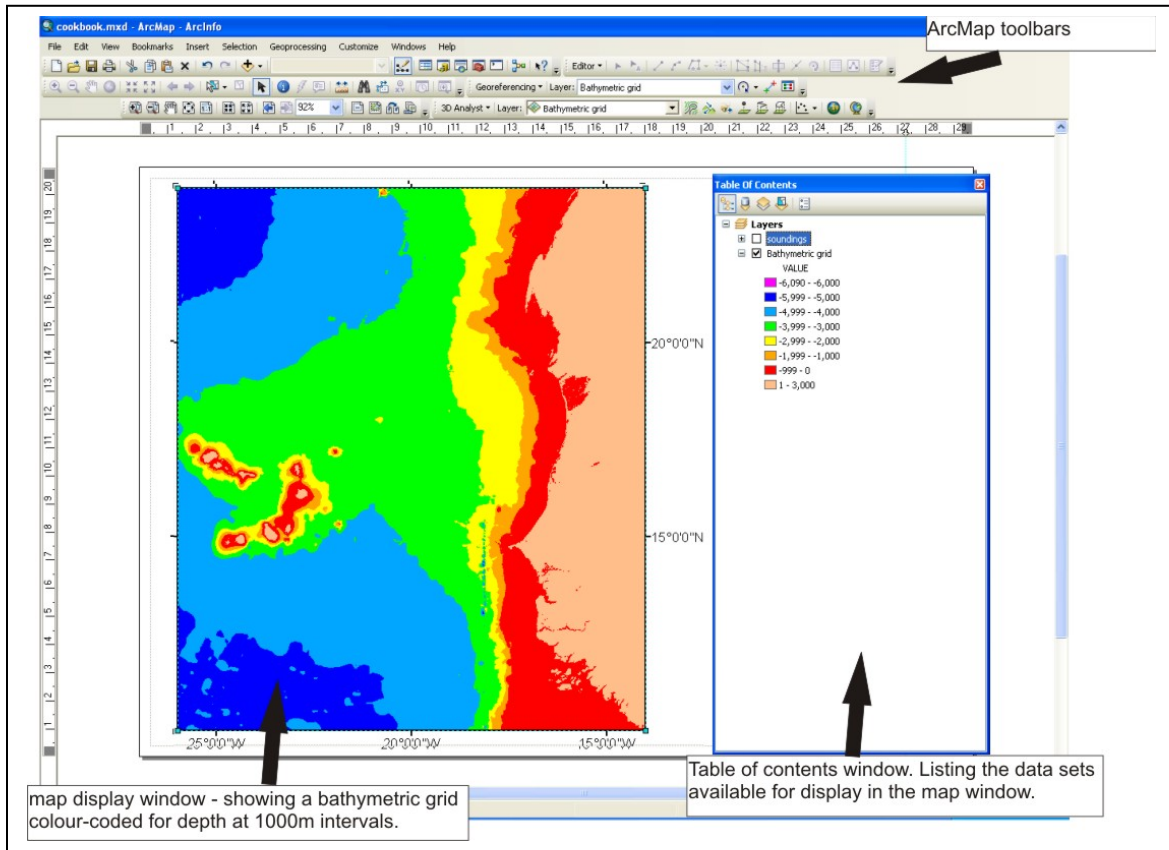

In the above example a bathymetric grid is displayed colour-coded at 1000m intervals

The grid will appear in the layers list in the table of content. Right click on the grid's file name and then click on 'properties'. For raster data sets, you can choose to display the grid using stretched values along a colour ramp, you define the start and end colour values, using values and classified intervals, e.g. equal intervals, natural breaks, defined intervals etc. or unique values for each separate cell attribute. You can define a colour scheme, choosing from pre-existing colour schemes or defining and saving your own colour scheme.

You can change the properties of individual colour intervals, perhaps changing one interval to be transparent, this helps with overlaying data sets. You can also make a selected range of values one colour, for example for land areas.

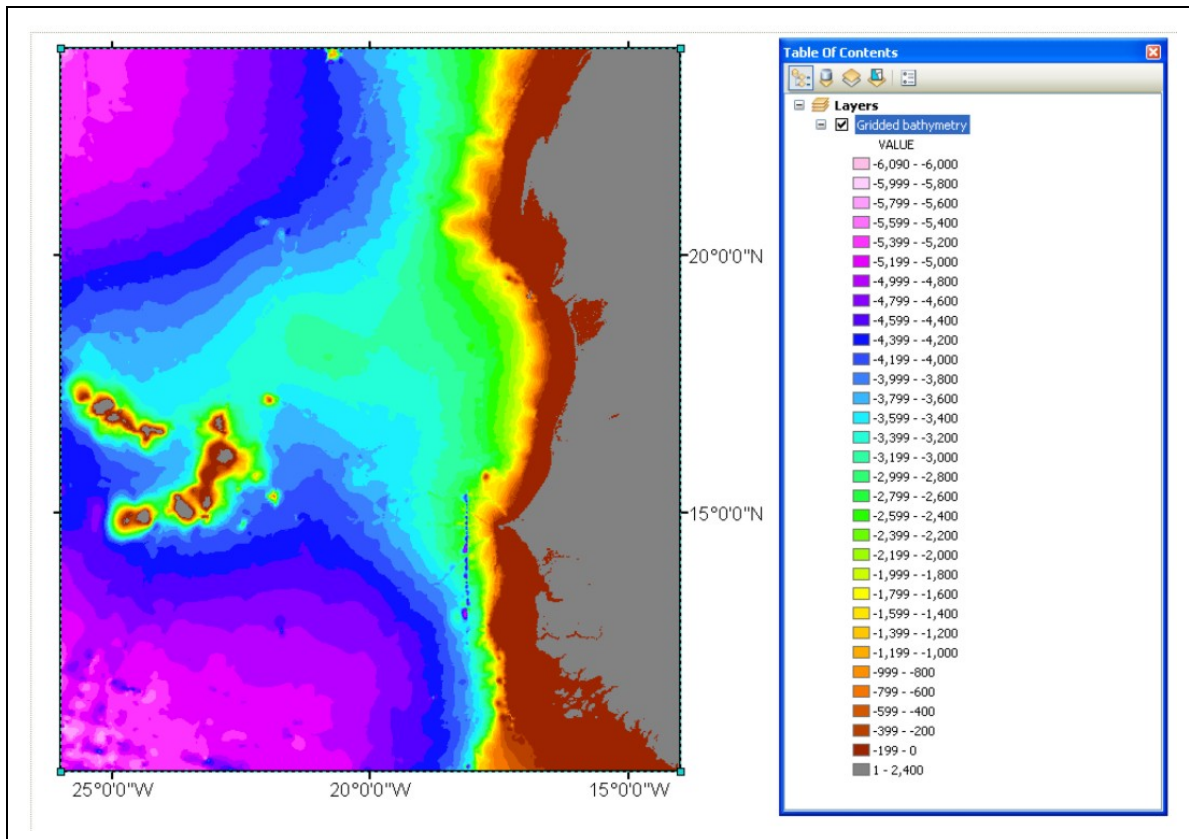

In the above image the grid is now coded at depths of 200m intervals and land areas are displayed in grey.

Further information about choosing display colours can be found in 'help' system.

[http://help.arcgis.com/en/arcgisdesktop/10.0/help/index.html#/About_displaying_layers/00s5000000001s000000/](http://help.arcgis.com/en/arcgisdesktop/10.0/help/index.html#/About_displaying_layers/00s5000001s000000/)

For vector data, you can change the symbology used to display the data set to get the most out of your data set. Symbols can be defined on size of attributes and/or colour and attribute information can be displayed on the map. For example, when plotting sounding points you can colour code them for attribute information such as depth or for contributing organisation.

You can change the drawing order of the displayed layers, for example to plot points on top of a map. For further information on working with layers:

http://help.arcgis.com/en/arcgisdesktop/10.0/help/index.html#/A_quick_tour_of_map_layers/00s500000015000000/

Example of using ArcMap and ArcScene to help assess a bathymetric grid

As described above, ArcMap can be used to visualise your data sets in 2D. In the following example a grid is loaded into ArcMap. Colour coding the grid at defined depth intervals

highlights some features in the grid. Overlaying the source sounding data, used to generate the grid, can help investigate the origin of the features and let us determine if there are any errors in the source data.

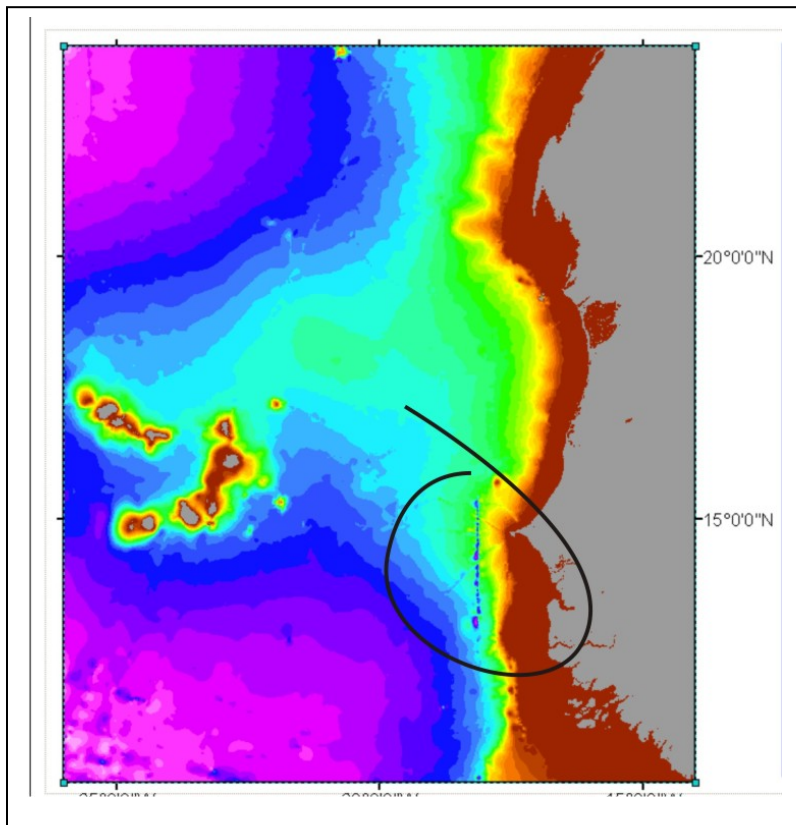

The above image seems to show an anomalous feature (circled), shown as a 'blue line'. We can investigate the original of the feature by overlaying the source sounding data that was used to generate the grid onto the map display.

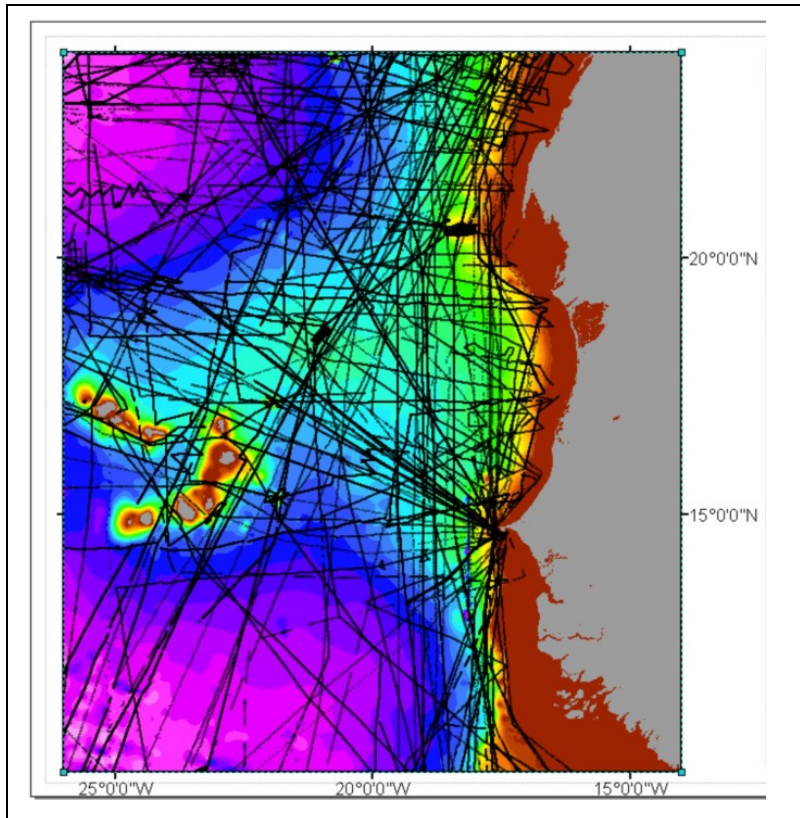

The above image shows the coverage of ship-track data (shown in black) which was used to generate the bathymetric grid.

The ship-track soundings, as xyz data, can be colour-coded for their various available attribute, e.g. depth or source survey. This can help to visually identify any spikes in the data set.

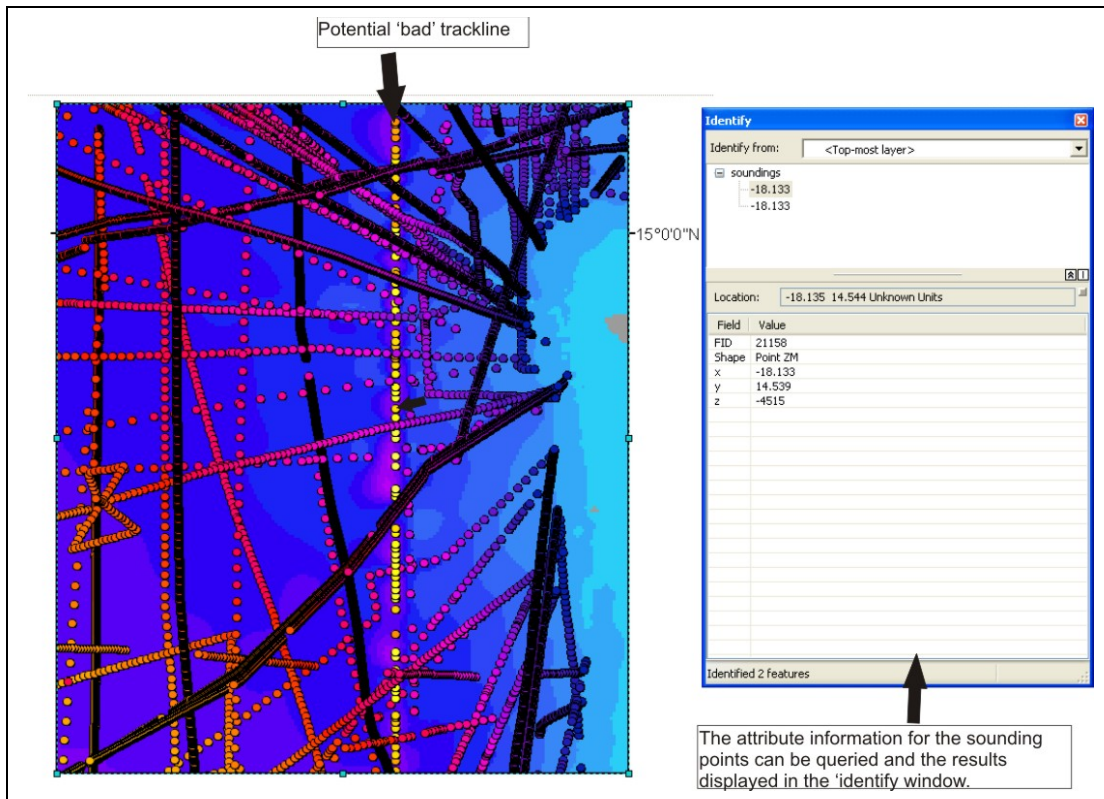

The above image is zoomed into the area of the anomalous feature. The source sounding data file has been colour coded for depth. We can see that a trackline plots along the anomalous feature, judging from the colour of the soundings, they appear to be a different depth value of those in the surrounding region – they may be in error and causing the anomalous feature in the grid. We can query the soundings to find out the depth of the individual sounding points and if available, query the accompanying metadata.

In addition to viewing the gridded data in 2D using ArcMap, **ArcScene** can be used to view the data in 3D.

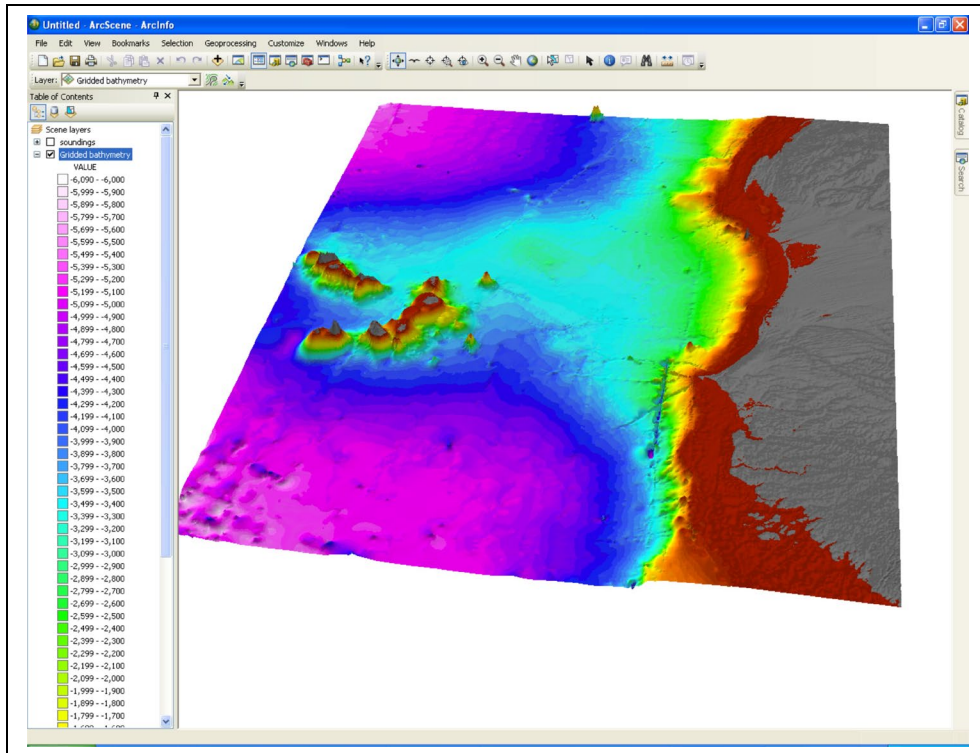

The above image shows the grid displayed in 3D in ArcScene. Potential errors in the grid are now more visible.

We can zoom into the image to investigate further and also overlay the source sounding data onto the grid. In the example below, the anomalous feature is displayed in 3D and overlain by the source sounding data points.

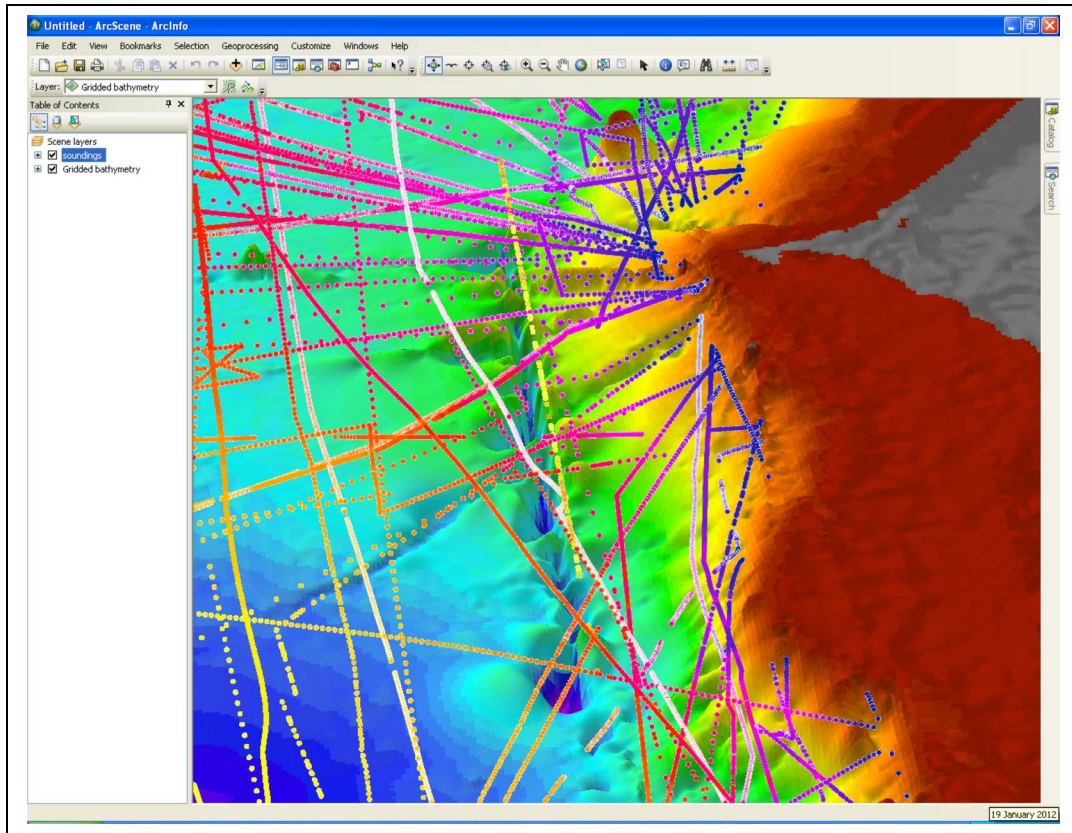

How can I get help with using the software?

There are documents and links on ESRI's web site under 'support' <http://support.esri.com/en/>

ArcGIS Support: <http://support.esri.com/en/>

ArcDesktop help: <http://help.arcgis.com/en/arcgisdesktop/10.0/help/index.html>

Technical articles: <http://support.esri.com/en/knowledgebase/techarticles/index>

About ArcGIS for Desktop: <http://www.esri.com/software/arcgis/arcgis-for-desktop/index.html>

An introduction to commonly used GIS tools:

http://help.arcgis.com/en/arcgisdesktop/10.0/help/index.html#/An_introduction_to_the_commonly_used_GIS_tools/002s00000006000000/

4.2 CARIS HIPS (Hydrographic Information Processing System)

Contributed by Capt. Izabel Jeck, Directorate of Hydrography and Navigation (DHN), Brazilian Navy, Brazil

4.2.1 Introduction

The purpose of this document is to present to the user the basic workflow of the program CARIS HIPS (*Hydrographic Information Processing System*), version 7.0, to process multibeam data.

HIPS is a suite of comprehensive hydrographic data processing tools that can be used to process simultaneously multibeam, backscatter, side scan sonar, LiDAR and single beam data. CARIS HIPS is a program developed by a Canadian company named CARIS (www.caris.com).

To use this software it should be note the computer minimum configuration, this information and any extra information can be obtained in the software documentation or in CARIS web page.

4.2.2 Acknowledgements

This document was made with the contribution and the authorization of CARIS - Universal System Ltd. Company, and further information can be obtained in www.caris.com.

4.2.3 HIPS Workflow

The figure below presents the software workflow.

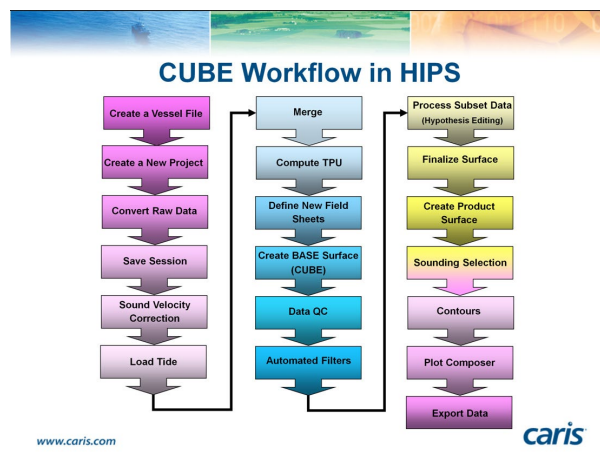

Create a Vessel File (HVF): Setup the sensor locations and uncertainties in the vessel reference frame.

Create a New Project: Setup the *Project - Vessel - Day* data structure.

Convert Raw Data: Raw data is converted into HIPS data format.

Save Session: Save the current workspace (data and current view).

Sound Velocity Correction: Load and edit sound velocity profiles and apply the correction.

Load Tide: Load tide data from one or more tide stations.

Merge: Combine vertical and horizontal information to produce geo-referenced data.

Compute TPU: Utilize uncertainty values entered in the HVF in an effort to compute the total propagated uncertainty of each individual sounding.

Define New Field Sheets: Define the map projection and location of the data.

Generate BASE Surface (CUBE): Merged data is used to produce CUBE surface.

Data QC: Sensors, such as navigation, gyro, heave, etc. are examined if problems have been identified in the BASE surface.

Automated Filters: Filter soundings using swath geometry and/or according to IHO survey order accuracies.

Process Subset Data: Validate CUBE surface and edit the geo-referenced soundings directly, on many lines simultaneously, where the CUBE surface has been adversely affected by erroneous soundings.

Recompute: Update the BASE Surface after the data has been edited and the surface has been validated.

Finalize: Finalize BASE Surface to ensure designated soundings are carried through to bathymetric products.

Create Product Surface: Produce a generalized product surface from the BASE Surface.

Contours: Use either the BASE Surface, product surface or tile set to output contours.

Sounding Selection: Use a height source for selection of a representative sounding set.

Export Data: HIPS soundings and surfaces can be exported to various formats for data transfer.

Before start the processing the user must know:

- dX,dY,dZ sensor offsets
- echo sounder used and number of beams
- sensor timing corrections
- sensor bias corrections
- positioning format (geographic or ground coordinates recorded?)
- have calibration offsets been applied?
- has vessel motion been removed?
- has remote heave been removed?
- has draft been applied?
- has sound velocity corrections been applied?

4.2.4 Project Data Tree and General Information

The Control Window displays the data in an expandable tree. This display is organized to reflect the Project, Vessel, Day, Line directory structure. Data deleted from the Project tree is sent to the Recycler folder as defined in an Environment variable in the Options dialog.

Project information can be viewed in the **Project Properties** dialog box. General project information and information about the coordinate system is stored here. The project geodetics can be transformed using this dialog box if required.

Default Options

- Presentation and Performance

The default options can be accessed using the **Tools > Options** menu. The **Options** dialog box is organized into six tabs.

The **General** tab controls zoom and pan factors, and settings for displaying sounding size, the SVP location symbol and the navigation point symbol. The pick aperture setting determines how close the cursor has to be to an item in order to select it. A number of other options can be enabled or disabled in the General tab.

The **Display** tab controls the colour of lines and backgrounds in different parts of HIPS and related editors.

Under the **Display** tab the user can configure the presentation of Geographic or Projected Grids & Scale Bars for the HIPS Display window. Grids, which can be displayed as lines, ticks or crosses, will be displayed, with a scale bar, appropriately for the current zoom factor. Under the **Units** section users can configure the display units for their data.

All data in HIPS is stored in metres and so the conversion will be applied to the display of the data.

- Directories and Environment

The **Directories** tab enables the user to modify the location of project dependent data files, either one at a time or by using the **Root Path**, to set all the HIPS and SIPS data paths at once, if they all have the same base path. This information is saved to the registry.

The **Environment** tab enables the user to modify the locations of the HIPS and SIPS support information, such as the master file, symbol file, datum file, scratch location, etc.

By default, this information is located in the ..\CAIRS\HIPS\System directory.

- S-52 and S-57

The **S-52** tab controls the display of S-57 ENC data, there are options to select colours and transparency for depth areas, symbols, contours etc.

The **S-57 Environment** tab controls the location of S-57 dependent configuration files.

- 3D View

The **3D** tab controls the behavior of the keyboard and mouse controllers when navigating the 3D View:

• Controller Type

- Terrain Flyer: navigate from the perspective of the height source.

- First Person: navigate from a camera view of the current 3D scene.

• **Flight Speed:** Controls the speed at which you move through the display during a fly-through.

• **Zoom Speed:** Controls how fast the view is changed when using the zoom controls.

• **Smooth-Fly-To Speed:** Controls how fast the view is changed when a user double-clicks an area of the 3D View.

Open Background Information

Both vector and raster information can be loaded into HIPS as background information. This option can be accessed using the **File > Open Background Data**.

Layers Data Tree

The **Control Panel** displays the data in an expandable tree. This display is organized to reflect the layers of data displayed in the HIPS Display Window. It is possible to toggle these layers on and off using the check boxes in the **Layers** tab, and the draw order of the layers can be changed by dragging and dropping the layers in the **Draw Order** tab.

Entire Fieldsheets can be turned off from the right-click context menu.

In order to select data such as track lines in the Display Window, the layer must first be highlighted in the **Layers** tab of the Control Window.

Selecting Data in HIPS and SIPS

Survey lines can be selected by highlighting them in the Project tab of the Control Window, or by clicking on them in the Display window. Multiple lines can be selected using the shift and control keys. Lines can also be selected by dragging a box over the lines in the Display Window. Selection in the Display Window can be done in two ways: **Select by Range** or **Select by Lasso**. Lines cannot be selected when the cursor is in constant zoom mode. When in constant zoom mode. To exit from zoom mode, click on the zoom icon or use the ESC key.

Other selection options are **All in Display**, **All and Clear Selection**.

Note: The Select by Range tool is depressed by default. If you are unable to select lines in the Display Window check to see that this tool is selected.

Query Lines

- Generate report of line status and statistics
- Select Query fields and sort

www.caris.com

All the information listed when a line is queried is calculated on-the-fly so it may take a few minutes to list. The data is displayed in the Worksheet Window and the columns can be sorted by clicking on any of the headings. By right-clicking on the headings and selecting **Query Fields...** from the pop-up menu you can choose which fields are displayed. The options **Select All**, **Copy** and **Paste** and **Save As...** allow the contents of the Worksheet Window to be taken into software like Excel.

Right-click in the Display Window brings up a pop-up menu you can use to copy the geographic coordinates of the cursor position to the clipboard.

4.2.5 HIPS Workflow- Detailed

Vessel editor

The Vessel Editor is used to create and edit HIPS Vessel Files (HVF). The HVF contains information necessary for combining all sensor data to create a final position/depth record. Sensor information is used during the merge process. All sensor entries are time stamped, therefore one HIPS vessel file can be used for the life of a vessel. If a sensor is moved or added, the new offset information is given a new timestamp. The merge process compares the date and time of the observed data with the date and time of the HVF sensor information to ensure that the appropriate offsets for that time are used.

Note:

It is not possible to process sensor data time stamped prior to the earliest HVF timestamp, as the program applies the most recent information.

The positions of the sensors in the HVF may not be the same as the actual configuration of the vessel. For example, if sensors offsets are applied in the acquisition software, the HVF should describe the 'corrected' position, not the actual position of the sensor.

The vessel editor can be accessed using the edit > vessel configuration... from the main menu.

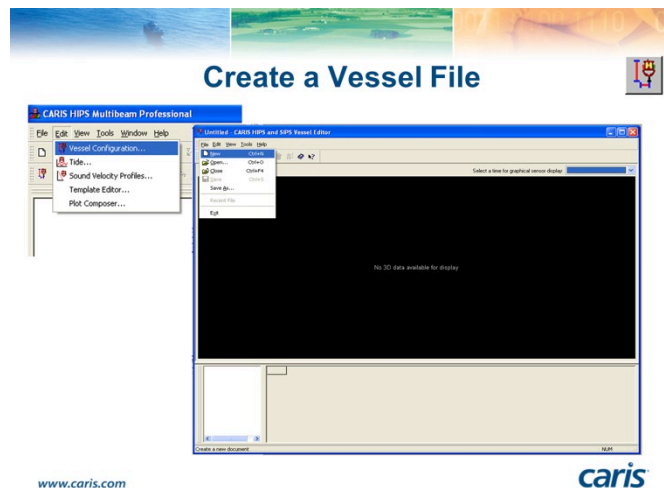

The figures below present HIPS coordinate system to be considered in the VESSEL EDITOR - SENSOR SECTIONS)

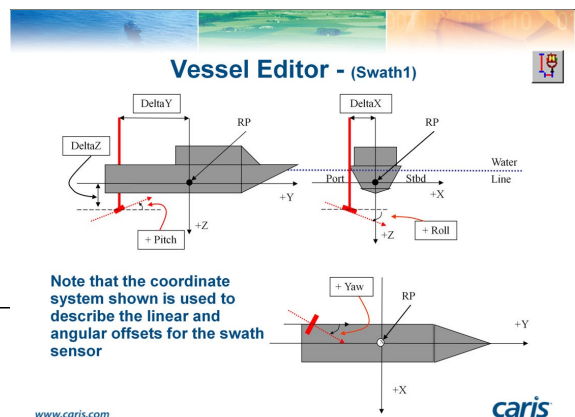

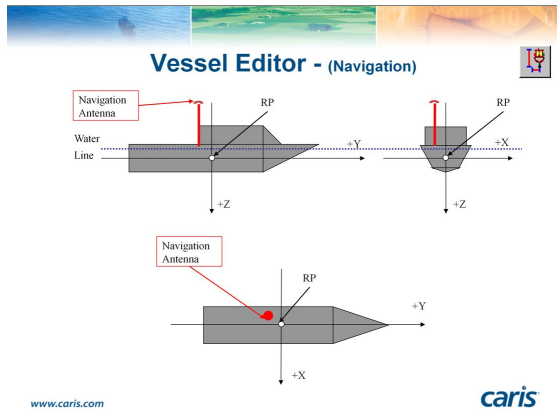

Create a New Project

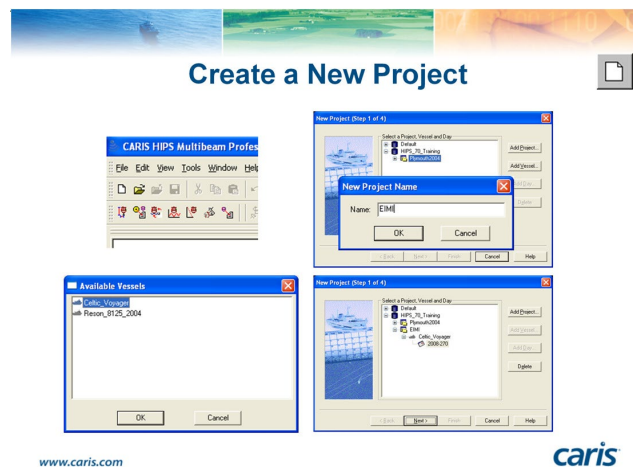

A list of existing projects will be displayed in the option **file > open project**, you can also create a new project using **file > new**.

Note: Do not use spaces in the name of the project.

In the **file > new**, highlight the project created, click the **Add Vessel...** button and select the hvf vessel file; click the **Add Day...** button. Select the geographic parameters for the project.

Note: Regions of the world appear in the **Group** list. When a group is selected, the user can select from a pre-built set of map **Zones**. These parameters are referenced by the Map Definition File (Hips\System\mapdef.dat). This file can be appended to if additional definitions are required or another file can be selected by accessing **Tool > Options** from the main HIPS menu and then selecting the **Environment** tab.

The user may also opt to have the program automatically select the appropriate UTM zone.

Define a geographic window for the project. The default region is the entire globe. If an existing project in the area is open, the **Current View** button can be used to get the extents.

Convert Raw Data

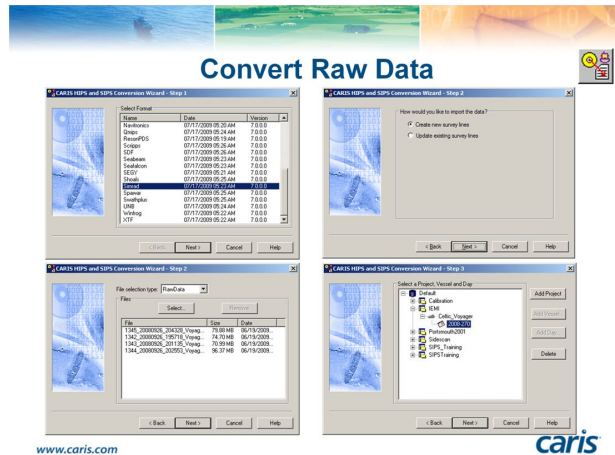

- Select the **Conversion Wizard** icon or **File > Import > Conversion Wizard...** from the menu to start the conversion wizard.
- Select **data format** from the list of formats.
- Select the **File selection type** from the list, in this case **RawData**
- Select all the lines.

Raw data files are usually stored in PreProcess so this is the default location.

- Select the destination Project, Vessel, and Day folder for the converted
- Select the geographic reference system used for the acquisition of the raw data. If Ground Coordinates are used, the appropriate zone definition needs selecting from the list. If Geographic Coordinates are used nothing more needs to be set.
- Do not set **Navigation** or **Depth** filters. The **Navigation** filter is useful to restrict data to a specific geographic region. The geographic region can be defined manually or by Project File extents. The **Depth** filter is used to reject large bathymetric spikes that fall outside of the min and max depths of the survey area.

The first five steps of the Conversion Wizard are the same for all data formats. From Step 6 the wizard differs to accommodate individual requirements for each format type.

The **<Back** button can be used to check that no mistakes have been made in the settings. Once the line data has finished converting the **<Back** button changes to **<< Restart**.

Open Survey Data

Sound Velocity

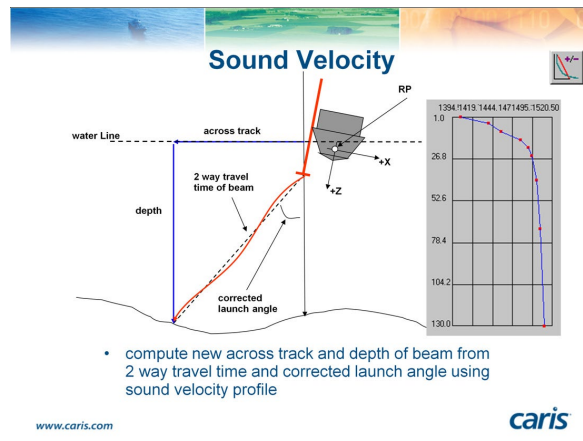

Raw data formats such as Simrad contain two-way travel time and beam launch angles. Producing a geographically referenced sounding position and depth from this data is a two-stage process.

- The procedure for calculating the length and path of the sound wave through the water column for each beam is called the Sound Velocity Correction (SVC).

The result is an along-track/across-track/depth for each beam.

- The Merge process (which is explained later) converts the along-track/across-track/depths into latitude, longitude, depth by combining the ship navigation with horizontal and vertical offsets in the HIPS vessel file.

The SVC algorithm calculates the ray path of the sound wave through the water column for each beam. In order to do this the program needs to know several things:

- Any rotations that have to be applied to the sensor head – both static (i.e., setup and calibration parameters) and dynamic (measured by the attitude sensors).
- The acoustic velocity of the water column. This information is loaded into the program as a sound velocity profile.

There are different options for applying velocity information to a swath:

- **Previous in time** – This is the method traditionally used by HIPS, which applies the profile taken immediately before the collected swath.
- **Nearest in time** – In this situation HIPS will apply the SVP with the time stamp closest to that of the collected swath.
- **Nearest in distance** – Uses the position attributes of the profile to determine the nearest profile to a given swath.
- **Nearest in distance within time** – Uses the position attributes of the profile to determine the nearest profile to a given swath within a time window which the operator has to enter.

Note:

The profile selection methods listed above are made on a swath-by-swath basis and so it is possible to have several SVPs used in the same survey line.

For Simrad data, the sound velocity and attitude corrections have been applied during acquisition, and do not need to be reapplied.

The process checks the HVF to see if the heave, pitch, and roll are set to Apply “Yes”. Since Simrad has already corrected for Sound Velocity, it does not have to be re applied. Doing so would skew the data.

Note that in this case there is no sensor called SVC to the Vessel File (hvf). This sensor would need to be configured in order to apply (or reapply) sound velocity.

Sound Velocity Correction

SV Correction and Merge

<p>Applied during SVC</p> <ul style="list-style-type: none"> •SVP (Z) •Heave •Pitch •Roll •Waterline •Dynamic Draft * •SVP 	<p style="text-align: center;">Applied During Merge</p> <table border="0" style="width: 100%;"> <tr> <td style="width: 50%; vertical-align: top;"> <p style="text-align: center;">If SVC Applied</p> <ul style="list-style-type: none"> •Swath (X, Y, time-error, Roll, Pitch and Yaw) •Gyro •Navigation •Tide •Dynamic Draft </td> <td style="width: 50%; vertical-align: top;"> <p style="text-align: center;">If SVC Not Applied</p> <ul style="list-style-type: none"> •Swath (X, Y, Z, time-error, Roll, Pitch and Yaw) •Gyro •Navigation •Heave •Pitch •Roll •Tide •Waterline •Dynamic Draft </td> </tr> </table>	<p style="text-align: center;">If SVC Applied</p> <ul style="list-style-type: none"> •Swath (X, Y, time-error, Roll, Pitch and Yaw) •Gyro •Navigation •Tide •Dynamic Draft 	<p style="text-align: center;">If SVC Not Applied</p> <ul style="list-style-type: none"> •Swath (X, Y, Z, time-error, Roll, Pitch and Yaw) •Gyro •Navigation •Heave •Pitch •Roll •Tide •Waterline •Dynamic Draft
<p style="text-align: center;">If SVC Applied</p> <ul style="list-style-type: none"> •Swath (X, Y, time-error, Roll, Pitch and Yaw) •Gyro •Navigation •Tide •Dynamic Draft 	<p style="text-align: center;">If SVC Not Applied</p> <ul style="list-style-type: none"> •Swath (X, Y, Z, time-error, Roll, Pitch and Yaw) •Gyro •Navigation •Heave •Pitch •Roll •Tide •Waterline •Dynamic Draft 		

* Used for SVC, yet not applied to depths

www.caris.com **caris**

As stated earlier, some of the parameters that are usually applied in the merge process can be applied during the SVC process.

If you sound velocity correct your raw data to produce a new observed depth, the merge process knows what has been applied and will not reapply it as SVC is optional.

The following are taken into account during SV correction:

- Travel Time - angle observations
- Sound Velocity Profile
- All entries in the SVP section.
- Water line
- Dynamic heave, pitch and roll, along with any errors. Including pitch and roll induced heave calculated from MRU lever arm offsets (X, Y and Z of motion sensor)
- Dynamic Draft - uses a table of speed versus draft values in the HVF.
- The Dynamic Draft values are only used to find the proper sound velocity layer to start SVC. The draft values will be applied to the observed depths in the Merge Process.

Note: The dynamic heave, pitch and roll will only be applied if **Apply** is set to **Yes** in the HVF for each individual parameter. However, the offset values for Roll, Pitch and Yaw entered into the Swath/SVP will always be applied.

Tide Loading

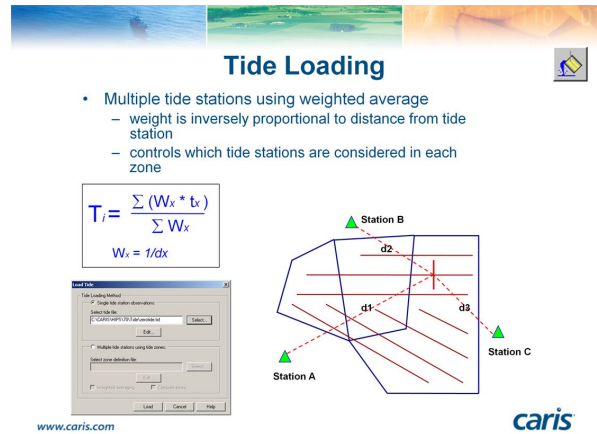
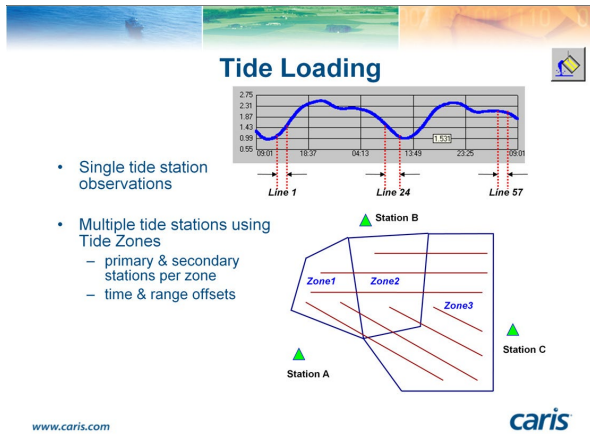

Tide data can be applied in two ways:

- The tide data from a single tide station can be applied to each survey line as a whole.
- Tide data from multiple tide stations can be compiled. The tide data is loaded for each part of a line as determined by the zone the part falls into.

To define a tide zone several parameters are required:

- Zone boundary in geographic coordinates.
- The location of the primary tide station.
- Locations of up to 3 optional secondary tide stations.
- Time offset in minutes for each station.
- Range offset / tide scalar for each station.
- Outage limit in minutes controls when data will be extracted from secondary stations.
- Interpolation interval in seconds for final interpolated tide loaded into each survey line data structure.

Note: When using data from multiple stations, a weighted average of tidal observations along the survey line is generated. This only works if the information about the tide coefficients is given in the tide zone file. The weight given to the tide data is inversely proportional to the distance between the station and the swath data, which is why the zone definition file should include latitude and longitude positions for tide stations.

To apply tide you have to select all of the lines and click on the **Load Tide** tool button or select **Process > Load Tide**.

The tide weighting formula can be expressed as the following;

T_i = The tide value for the i th profile along the line

t_x = The tide value from the x th tide station for the time and location of the i th profile

W_x = The weight of the tide value coming from the x th tide station

d_x = The distance between the i th profile along the line and the x th tide station.

GPS Tide

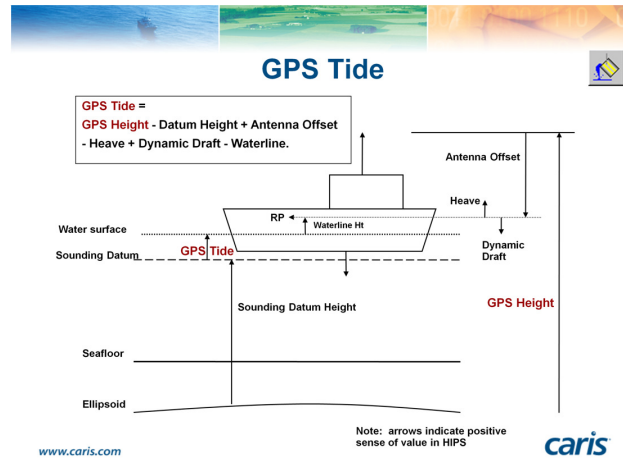

HIPS has the ability to use ellipsoid heights from GPS RTK instead of traditional tide data.

GPS Tide data is applied optionally as part of the Merge process. It is used as a direct replacement for regular tide data. The vessel configuration is used as normal with respect to transducer offsets, calibration values, application of heave, pitch, and roll, etc.

In order to apply GPS tide you first need to calculate it. This calculation is performed with the **Process > Compute GPS Tide...** command.

To be able to use the GPS height information for tidal corrections, the separation between the ellipsoid and the vertical survey datum needs to be known. When computing the GPS tide this separation can be entered as a single value or a model file can be used. Two binary sounding datum models can be used for computation of GPS tide:

- GEOID99
- EGG97 (European Gravimetric Geoid 1997)

Alternatively, an ASCII sounding datum model can be used. The data must be in the format Lat, Long, Z, for example: -33.848326,151.192435,20.4

Not in all cases raw GPS height will be recorded in the raw data files. The used acquisition system may already have made corrections on this data. To allow for this it, is possible to select which terms of the GPS tide computation should be applied and which not. If a sensor has already been applied on the GPS heights by the acquisition system, it should not be applied by HIPS. Only corrections that are selected in the Compute GPS Tide dialog will be applied in the computation.

Merge

Merge takes into consideration all of the horizontal and vertical offsets in the HVF to produce a processed sounding.

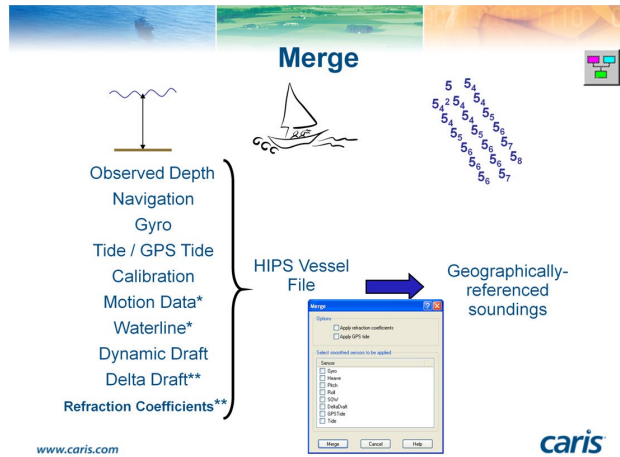

Parameters marked with an * have been applied in the SVC process. Some additional parameters need to be selected as part of the Merge process. These include:

- Apply Refraction coefficients
- Apply GPS tide
- Smooth Sensor data

Compute TPU

Compute TPU

Reduced depth uncertainty (Dp TPU)

$$\sigma_{Dp} = \sqrt{\sigma_d^2 + \sigma_{D_H}^2 + \sigma_{D_D}^2 + \sigma_{D_H}^2}$$

Total positioning uncertainty (Hz TPU)

$$\sigma_{P_{Final}} = \sqrt{\sigma_p^2 + \sigma_{p_a}^2 + \sigma_{p_r}^2}$$

In order to generate TPU values for each sounding, the definition of uncertainty estimates for each of the contributing sensor measurements has to be combined using a propagation algorithm. The result is a separate uncertainty estimate for the depth, **DpTPU**, and horizontal position of the sounding, **HZTPU**. The results are presented at the 95% confidence interval which is equivalent to 1.96 x the standard deviation.

The compute TPU function must be performed after the Sound Velocity correction. Whether it is applied before or after Merge will depend on your adopted workflow. When you compute TPU it will always be done on the Observed depths, therefore tide and draught offsets will not affect the values.

This calculation is performed with the **Compute TPU** tool button or **Process > Compute TPU**. The TPU values will be calculated for the soundings based on the errors defined in the HVF, the Total Propagation of Uncertainty algorithms and the survey specific uncertainty estimates

defined.

Defining New Field Sheets

Field sheets are essential for the creation of Weighted Grids and BASE Surfaces.

Field Sheets can be created in locations other than the directory directly under HIPS.

To create a New Field Sheet the user can use the **New Field Sheet** tool button or select **Process > New Field Sheet**.

- Enter a Name for the Field Sheet.

Note: Field Sheet names should be made up of alphanumeric characters only and should not contain spaces.

- Enter a Scale.

- Leave the default values for the **Horizontal** and **Depth Resolutions**. This will define the measurable accuracy of the coordinate and depth resolutions.

- Confirm the **UTM Zone / Mercator**

- Define Field Sheet extents by three ways:

1) Select the Current Display button to use the current display as the perimeter.

2) Define the extents with the mouse by clicking on the User Defined Area button.

3) Type in the coordinates for the bottom left and top right corners of the field sheet.

- Create a user defined Field Sheet large enough to accept all of the data in the survey area.

Once a new Field Sheet has been created it will appear as a new layer in the Layer tab of the Control Window. The display of the Field Sheet name and outline can be controlled by the Properties dialog box.

The Field Sheet icon in the Control Window is green, meaning that this is the active Field Sheet.

If you have more than one Field Sheet open then it is possible to change which is set as active.

This is achieved by right-clicking on the Field Sheet name in the Control Window and selecting the **Set as Active Field Sheet** option from the pop-up menu.

The BASE Surface

The BASE Surface

Swath Angle

- Soundings weighted using sonar geometry

Uncertainty

- Soundings weighted using uncertainty information

CUBE

- Soundings weighted using uncertainty information
- Multiple depth estimates
- Filter bathy data against generated surface

Common Attributes

- Smooth surface and contours
- Bathy detail preserved
- Ability to preserve shoals

caris

HIPS supports the ability to create three different surface types:

- the Swath angle surface,
- the Uncertainty surface, and
- the CUBE surface.

Through the BASE Surface Wizard the user can select which type will be created. The surface types use different weighting algorithms to produce gridded images of the sonar data. All three surface types will produce a smooth surface that retains the sonar resolution. The user also has the ability to preserve shoal or critical values.

The CUBE surface is also a powerful, semi-automated cleaning tool that can be used to increase processing efficiency. Both Swath and Uncertainty surfaces can also be used for cleaning to some degree.

BASE Surface

When the cursor is moved over the BASE Surface, tool tips are displayed showing the value for the nearest Base Surface node. This option can be toggled on/off in the **Tools > Options** menu option under the **General** tab.

BASE Surface nodes can also be selected and queried. To query surface node values, enable the display of the surface in the Control Window and highlight that layer. Left click and drag to select an area of nodes. Select the **Edit > Query** menu option to have the XYZ values of the selected nodes displayed in the Query window.

Note: To obtain the maximum BASE Surface resolution it is often best to create a small BASE Surface and work upwards. If working with a single resolution the first BASE Surface you create may be 1% of the average water depth. The other option is to create a surface with a resolution that varies with the water depths of the survey area.

The initial BASE Surface may contain holes; the holes represent areas where the data was not dense enough for the resolution selected. In such areas you can interpolate to fill in the holes.

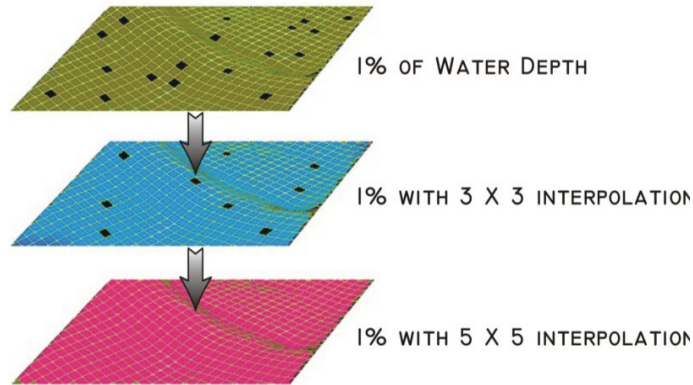

Swath Angle Surface – Theory

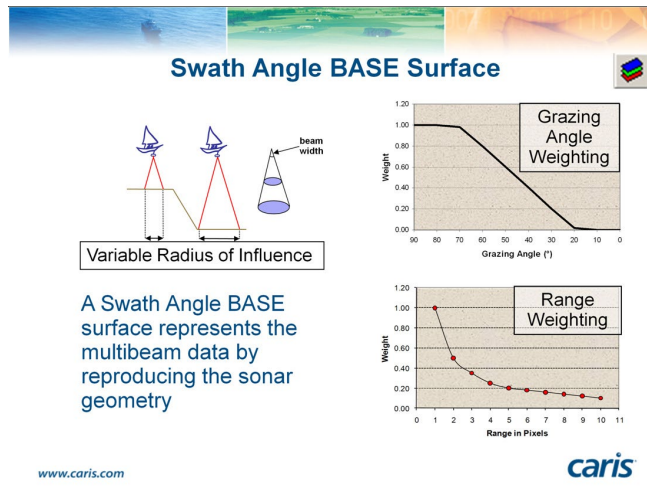

The Swath Angle BASE surface is a rasterization method specifically designed for multibeam data. It is an accurate representation of multibeam data because it considers the actual geometry of the sonar system. It does this in three ways:

Variable radius of influence - The radius of influence of each sounding is calculated from the beam width of the selected sonar, and increases with depth and grazing angle. This addresses the increase in footprint size with distance from the sonar head.

Range weighting - The range weighting for each sounding decreases with distance from a node. This lessens the effect that soundings further away from the node will have on the BASE surface.

Grazing angle weighting - Errors in multibeam data tend to increase in magnitude in the outer beams due to the longer ray path distances. This tends to magnify refraction problems and other errors. The grazing angle weight function is applied to each sounding to reduce the effects of the outer beam soundings on the BASE Surface.

This weight function is controlled in an ASCII file called `GrazingAngleWeights.txt` in the `HIPS\System` directory. This file can be modified by the user

Uncertainty Surface – Theory

Uncertainty BASE Surface

- Uncertainty BASE Surface
 - Utilizes calculated TPU values
 - Sounding contribution to each BASE Surface node is dependent on IHO S-44 survey orders

www.caris.com

As mentioned previously, the horizontal TPU (HzTPU) and depth TPU (DpTPU) values are used in the creation of an Uncertainty BASE Surface. When creating an Uncertainty BASE Surface each sounding value will have an associated depth uncertainty and horizontal uncertainty. The depth uncertainty that each sounding has increases with the horizontal distance from the surface nodes. Therefore the greater the distance, the greater the uncertainty, and the less the sounding will contribute to the node.

The point at which a sounding will no longer contribute to a node is dependent upon the IHO S-44 Order selected. A sounding will only contribute to a node if the propagated vertical uncertainty of the sounding does not exceed the vertical accuracy requirement specified by the order.

CUBE Surface – Theory

CUBE Surface

- CUBE Surface
 - Utilizes calculated TPU Uncertainty values
 - Supports multiple depth estimates at a given node
 - Filter data based on selected surface depth estimations

www.caris.com

The CUBE (Combined Uncertainty and Bathymetry Estimator) Surface can be used as a cleaning tool in the HIPS workflow, besides being an end product or for product creation.

During the CUBE Surface creation, soundings are weighted and contribute to surface grid nodes based on TPU values and distance from the nodes. The weighting method is similar to the Uncertainty BASE Surface creation.

The CUBE Surface however, allows for multiple depth estimates or hypotheses to exist at a single grid node, depending on the variation of the sounding data. CUBE then uses “Disambiguation” to determine which hypothesis at each node is the most “correct”.

Users can verify, and if necessary override, CUBE decisions in Subset Editor. Once any necessary edits have been made to the CUBE surface, the CUBE filter can be applied to the data. Any sounding data that is not in agreement with the selected hypotheses will be flagged as rejected.

Before generating a CUBE Surface, all lines to be included must be merged and TPU must be computed.

- Highlight the field sheet name and then select the **New BASE Surface** tool or select **Process > BASE Surface > New**.

- Enter a name for the BASE Surface.

Note: It is a good idea to give the grid a name that relates to the resolution. Do not use spaces or non-alphanumeric characters.

- Enter a **Resolution**.

- Select **CUBE** for the **Surface Type**.

The Depth Filter can be used to limit the depth range of the generated surface to a specific interval.

- Set **IHO S-44 Order**.

- Select **Density & Locale** as the **Disambiguation** method.

- Click the **Advanced** button and ensure that the **Default Configuration** is selected on the Advanced Options dialog.

- Ensure that the **Initialization Surface** option is deselected.

The Disambiguation method will determine the method CUBE will use to determine the most likely bathymetry estimates. In this case it will use Density but if it is not confident in a selection it will utilize the Locale method.

The Advanced Options tab allows users to select or define the parameters to be used for the CUBE Surface creation. There are several pre-configured parameter sets available for selection. The configuration selection should be made based on the water depths and seafloor complexity of the survey area.

Note: Only experienced users should adjust or define the CUBE parameters. It is also possible for CUBE can use an Initialization Surface to ensure that grossly erroneous soundings will not be utilized in the CUBE surface creation. The CUBE surface will be visible in the Display window and the surface child layers, which are created by default, will be added to the Layers tab.

The CUBE surface contains the following layers:

- **Density:** The number of soundings that contributed to the selected hypothesis.
- **Depth:** The depth estimation of the selected hypothesis.
- **Hypothesis Count:** The number of different depth estimations at the surface node.
- **Hypothesis Strength:** A value to describe how mathematically confident CUBE is that the correct hypothesis was selected during disambiguation. Like Uncertainty, lower values are better.
- **Mean:** The mean of the soundings that contributed to the selected hypothesis.

-
- **Node Standard Deviation:** The combined standard deviation of the soundings that contributed to the selected CUBE hypothesis.
 - **Standard Deviation:** The average standard deviation of the soundings that contributed to the selected CUBE hypothesis.
 - **Uncertainty:** The vertical uncertainty associated with the selected hypothesis. Lower uncertainties are better.
 - **User Nominated:** This layer indicates if the hydrographer has nominated a hypothesis during hypothesis editing. This process will be explained further in a later exercise.
 - **Guide_Depth:** This layer represents the depth values of the initialization surface but resampled and displayed at the same resolution as the CUBE surface. This layer is only displayed if an initialization surface was selected during the surface creation.
 - **Guide_Uncertainty:** This layer represents the uncertainty values of the initialization surface but resampled and displayed at the same resolution as the CUBE surface. This layer is only displayed if an initialization surface was selected during the surface creation.
 - **Bounding Polygon:** This layer is a coverage polygon representing the boundaries of the data. The polygon includes the outer boundary of the data as well as an holes in the data.

The CUBE Surface can be shaded to assist in feature recognition. This and other image manipulation tools can be accessed via the Properties tab. This window can be used to manipulate the display of the various layers displayed in the Layers tab well as change the Disambiguation method used in the CUBE surface Creation.

Furthermore, the layer selected in the Layers tab will be displayed in the **Properties** tab. The following can be accessed when a BASE surface layer is selected:

- **Colour Map** and **Colour Range** – Control the display of images using **Colour Maps** (colours defined by pixel values) or **Colour Ranges** (colours defined by surface values). Colour Maps and Colour Ranges can be edited by click the Browse button to launch their respective editors.
- **Transparency (%)** – Set a transparency percentage to be applied to the display of the image. This is useful when displaying multiple images in the HIPS Display.
- **Depth Filter** – Filter the display of surface nodes by specifying a minimum and maximum depth value.
- **Raster Legend** – Enable the display of a Raster Legend to show the correlation between the surface values and selected colours in the HIPS Display window.
- **Shading and Vertical Exaggeration** – Shade the image to bring out surface texture. The shading can be changed by moving the sun symbol or entering values for Azimuth and Angle. Use the **Vertical Exaggeration** option to control the apparent vertical height of the surface, as this can also help to distinguish features.

Whether a surface is updated when changes are made in Subset Editor is defined using the “Keep Up To Date” flag for a surface.

Data Quality Control



Data Quality Control

- Problems with sensor offsets, auxiliary sensor data, etc. become apparent in the BASE Surface
 - Analyse and, if necessary, edit problem areas highlighted in the BASE Surface.
 - Technique to improve processing efficiency

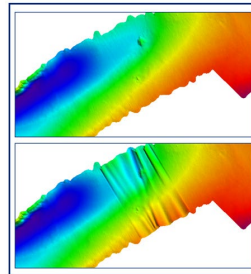

www.caris.com

caris

Prior to surface creation the auxiliary sensor data has not been investigated. The BASE surface can be used to highlight problems that may exist in the attitude and/or navigation data, problems which can be addressed using the Navigation and Attitude Editors.

By relying on the gridded data to highlight problems in the auxiliary sensors, processing efficiency can be improved, as the user is no longer required to investigate the motion and navigation of each survey line.

Note: A survey line must be selected before any of the line editors can be opened.



Data Quality Control

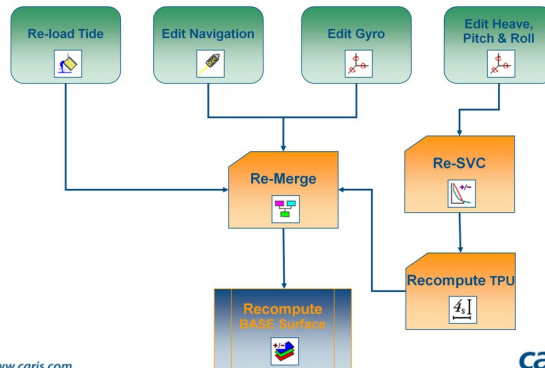

www.caris.com

caris

If changes are made to the navigation and/or motion data through the QC process it will be necessary to repeat previous steps in the HIPS workflow. The workflow diagram displayed here outlines the operations that need to be recalculated if changes are made.

Navigation Editor

The Navigation Editor lets you examine and clean individual position fixes as recorded by the vessel's positioning system.

- Select the first survey line in either the Control or Display Window.

- Select **Tools > Navigation Editor** or click on the Navigation Editor button in the Tools toolbar.

The **Navigation Editor** tab will be added to the Control window. This tab has four areas containing navigation editor controls:

-
- The **General** section allows the size of the navigation fixes to be changed. You can also specify if you want the points to be connected. You can select to display the graphs vertically or horizontally, and choose whether the minimum and maximum values displayed are for the entire line or the current view.
 - The **Interpolation method** section determines the interpolation method used. This can be either linear or a tight, medium, or loose bezier curve. These are explained on the next slide.
 - The **Spike detection** sections contain controls for finding speed jumps or time jumps.
 - The final section deals with the **Number of points that are displayed** in the Display Window, this can either be based on a zoom factor or a fixed value. Users may also enable the display of Gyro Indicators and set the length and colour to provide a visual indication for the direction that the survey line was run.

When checking navigation, keyboard shortcuts can be used to speed up the procedure.

Navigation Interpolation:

Position observations do not usually occur at exactly the same instant in time as a depth observation (ping). It is also unlikely that there is a position for every ping.

In most cases it will be necessary to interpolate positions to match the times for each ping. The interpolation method is set in the Interpolation method section of the Navigation Editor tab.

The default method is **Linear**, where interpolation between each successive position is obtained by simply connecting the positions with a straight line. Linear interpolation is suitable when the original navigation positions are clean and do not significantly deviate from the neighboring positions.

The other three options (Loose, Medium, Tight) are various degrees of **Bezier Curve**. In these cases the line of interpolation will not follow the navigation positions exactly.

Edit Navigation:

There are four main edit functions that are used when editing data in the navigation or attitude editors.

- **Accept** - This will change the status of all selected sounding positions to Accepted. This can also be activated using the **A** key as a shortcut.
- **Reject - Break Interpolation** - This will reject selected sounding fixes without trying to interpolate their position. (Navigation for the pings is interpolated from the navigation data.) This function causes all soundings between the navigation fixes immediately before and after the gap to be rejected. Use **B** as the shortcut key.
- **Reject -With Interpolation** - This rejects selected navigation fixes but interpolates a position over the gap. This can also be activated using the **W** key.
- **Query** - This gives the details of the fixes in the Worksheet window. The data can then be sorted in ascending or descending order by double-clicking the column heading. This can be useful for finding jumps and spikes. The **Q** key can also be used.

The whole line can be queried by right-clicking and selecting **Query Line** from the popup menu. This information is in memory, so it lists quickly, and the data can be pasted or saved as a text file for use in other software.

Attitude Editor

The attitude editor is used to display and edit sensor information.

You have to select a line, and then select the **Attitude Editor** tool button or **Tools > Attitude Editor**.

Gyro, Heave, Pitch and Roll sensor information is displayed by default. More sensors can be added by selecting them from the available sensors list, which can be accessed from the **Tools > Sensor Layout** menu.

Other sensor data could be GPS Tide, Side Scan Gyro, ROV Altitude etc.

The four default windows in the Attitude Editor display time series graphs for Gyro, Heave, Pitch and Roll. The tools to manipulate this data are available in the Control Window under the Attitude Editor tab.

When the cursor is placed on one of the time series graphs, the value is displayed as a tool tip.

Gyro data in CARIS HIPS is displayed as a positive value when a clockwise rotation is experienced.

Heave data in CARIS HIPS is displayed as a positive value when the vessel is heaved upwards.

Pitch data in CARIS HIPS is displayed as positive when the vessels bow is down. Roll data in CARIS HIPS is displayed as positive when the vessels starboard side is up.

Filtering:

The **Moving Average** option works by averaging data within a window. The window size can be based on seconds or number of data points. Increasing the size of the window increases the level of smoothing.

The **Fast Fourier** option takes out all frequencies which have a shorter wavelength than the box size set in points or seconds.

The **Threshold** option sets the cut-off value as a multiple of the standard deviation. The cut-off value is applied to the difference data. The **Difference** between the filter line and the sensor data is then calculated. This difference will be greater in areas in which local variability is high. Any difference values outside of the threshold limit will be rejected with interpolation.

Filtering can be applied in three ways: either the present screen only, filter to the end of the line, or filter the whole (selected) line. Filtering can be applied with or without interpolation. As in the Navigation Editor, sensor values may be **Queried**, **Accepted**, **Rejected** (with interpolation), or **Rejected** (break interpolation).

Motion data that contains high-variability noise can be addressed by using the smoothing routine. Smoothing parameters will be stored separately and applied during Sound Velocity Correction.

Swath Editor

The Swath editor is used to view and edit the multibeam swath data. This can be either a manual process or a semi-automated one using filters based on knowledge of the data.

After select the first survey line in the Project tab of the Control Window click on the **Swath Editor** button or select **Tools > Swath Editor**.

The Swath Editor has several windows:

- **Swath Editor** tab - A new tab appears in the Control Window, containing a number of sub-panels that are used to manipulate the data in the Swath Editor.
- **Plan View** - Displays the beams and swaths in plan view. The bottom of the display is the start of the line. The scroll bar can be used to page through the data.
- **Side View** - This is an along track profile of all the swaths in the Plan View viewed from the starboard side, so that forward is to the right of the window.

-
- **Profile View** - This view represents a single swath at a time viewed from the rear. The scroll bar can be used scroll through the individual profiles.
 - **Rear View** - This is the data displayed in the Plan View window viewed from the rear of the ship.
 - **Amplitude** - If the sonar data contains intensity information then it can be displayed in this window. This view can assist in feature recognition.
 - **3D View** - In addition to image manipulation in the 3D View, the data can be selected, rejected, queried and accepted.

Subset Editor

The Subset Editor is activated by either clicking on the **Subset Editor** icon or by selecting **Tools > Subset Editor > Open** from the main menu.

A new Subset tab will appear in the Control window, and an additional toolbar will be displayed. The cursor in the Display Window will change to crosshairs to define the outline of the subset to be edited.

To define a subset drag a box around the data to be included using the left mouse button.

The subset outline can be rotated by holding down the **Ctrl** key while drawing. The subset can also be resized by dragging the corner anchor points.

The yellow 2D profile window can be resized or moved by dragging the anchor points.

To move the 2D slice along the subset use the keyboard arrows.

The toolbar has the following options:

- 2D and 3D windows can be toggled on and off.
- The status of subset tiles can be set to incomplete, partially complete or complete.
- The subset can be locked, so that the no accidental resizing, moving, and rotation can take place causing a redraw. The subset can also be locked by pressing the <L> key.

The Subset Editor tab has the various Subset Editor items organized into a **Data** tree. By selecting the items in the **Data** tree, the corresponding properties will be displayed in the **Properties** section of the Subset Editor tab.

Subsets should not be too large. If they contain too many soundings they will take too long to open.

Editing windows:

The user can pan (middle mouse button) and zoom in/out (Ctrl+right mouse button) on the **2D View**. Other functionality includes:

- The **View Direction** of the data in the window is relative to the subset orientation. The yellow arrow on the subset outline in the Display points towards the top. The view direction should be selected with this in mind. Select **Automatic** to always have the 2D View display along the longest edge of the slice.
- Set the display by selecting **Auto** Exaggeration, **min/max** values or by adjusting it manually using the Vertical Exaggeration in the 2D View. You can also choose to **Include Rejected** soundings in the scaling. Soundings can be displayed as digits and graticule labels can be turned on and off.

The **3D View** is controlled in the same way as the 3D View for the Swath Editor. There are however functions that are specific to the Subset Editor.

- The **Data Display** options allow for the 3D view display **Type** to be set as Points, Spheres, Cylinders, Surface or Surface Wireframe. The Subset **Outline** and **2D view slice** can also be

enabled for display in the 3D View. **3D Dynamic Skip** reduces the number of points displayed while the 3D View is being manipulated by the user.

- Under the **Controls** the user can **Allow rotation under data**. This allows the operator to rotate the data beyond the horizontal and view the underside of the sounding data. The display of the Compass, Lighting and Exaggeration can also be enabled/disabled.

Recompute the BASE Surface

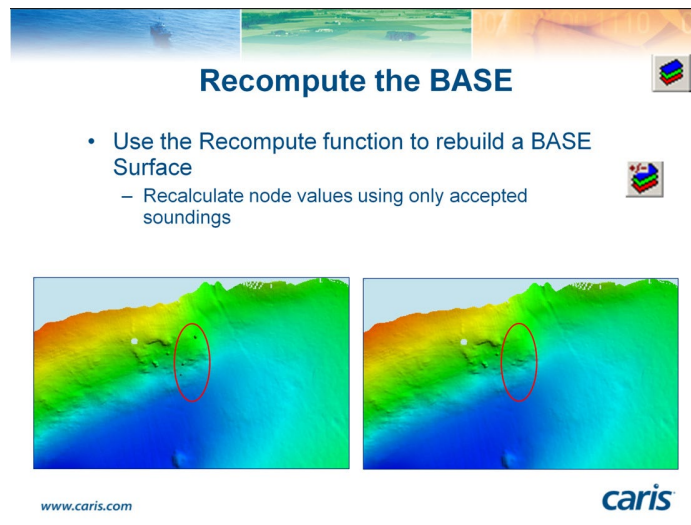

Recompute the BASE

- Use the Recompute function to rebuild a BASE Surface
 - Recalculate node values using only accepted soundings

www.caris.com caris

After you have finished editing the data in the Subset Editor and exited out, or cleaned the bathymetry using the Surface filter, the BASE Surface may appear outdated. This is indicated by a red exclamation mark on the BASE Surface icon in the Session tab of the Control Window. The **Recompute** function enables quick recomputing of a BASE Surface to update any changes that have been made.

If all manual edits had been performed in the Subset Edit with the **Automatic BASE surface update** option selected under **Tools > Options** the surface would already be up-to-date and would not need to be recomputed. **Automatic BASE surface update** recomputes small sections of the surface as the user moves across the point cloud in Subset Editor.

If the surface is outdated select the BASE Surface from the Control Window, right mouse click and select **Recompute** from the pop-up menu.

All changes made during the editing process will be applied to the BASE Surface.

The data should now be geo-referenced and cleaned.

The HIPS data can now be used to create bathymetric products. These are generated in the Field Sheet Editor.

Bathymetric products include Selected Soundings, Contours and others.

Product Surface

The first step to generating smoother contours is to create a Product Surface. The Product Surface maintains the designated soundings from the finalized BASE Surface and can be used to create more cartographically correct contours. A generalized surface is created by rolling an

imaginary ball over the BASE Surface. The user can specify the scale and radius of the ball. The ball will be rolled over the surface at the interval defined by the resolution.

The Product Surface is activated highlighting the Field Sheet layer and selecting **Process > BASE Surface > New Product Surface**.

Sounding Selection

It is impossible to display all soundings produced by a multibeam survey on a map or chart and maintain legibility. The selection of soundings that appear should be dependent on chart scale and purpose. Soundings can be created from a Tile layer or BASE Surface.

Click on the **Create Sounding Layer** icon or select the **Process > Products > Soundings > New Sounding layer**.

Soundings can be displayed in two ways, the soundings can be engineering style, with decimals, or they can appear as slanted soundings with drop decimeters.

Note: In most situations it is wise to use the same data source for soundings and for contours. This removes the possibility of producing soundings on the wrong side of contours.

Contouring

Contours are created using a three step wizard.

Open the Contouring wizard by clicking on the New Contour Layer icon or by selecting the **Process > Products > Contours > New Contour Layer**.

Contouring from different sources produces different results. The BASE Surface (swath angle method) is a mean surface, whereas tiles or bins can be shoal-biased. If you are creating products that will be used for navigation then a bin or uncertainty BASE Surface maybe a more appropriate source for building contours.

- Select the Depth layer of the generalized Product Surface as the height source.
- From the **Standard Contour** tab select an interval.
- The **Theme Number** will determine how layers are named and organised, this information can be used by CARIS GIS to differentiate the data.

Export Data

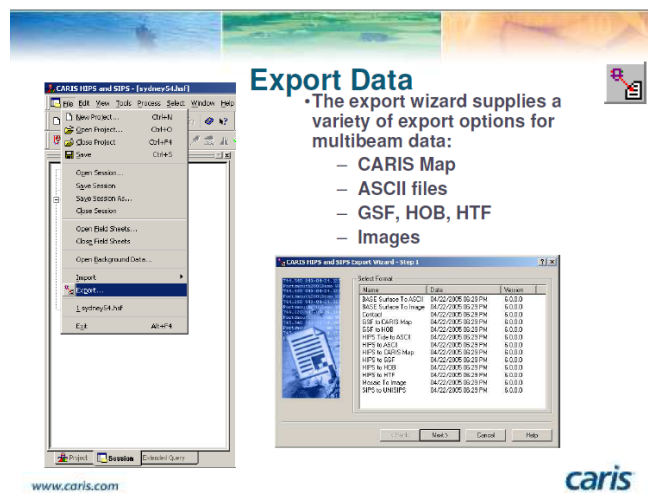

Export Data

- The export wizard supplies a variety of export options for multibeam data:
 - CARIS Map
 - ASCII files
 - GSF, HOB, HTF
 - Images

Name	Date	Values
BASE Surface To ASCII	04/22/2005 02:29 PM	0.010
BASE Surface To Image	04/22/2005 02:29 PM	0.010
Chart	04/22/2005 02:29 PM	0.010
GSF to CARIS Map	04/22/2005 02:29 PM	0.010
GSF to HOB	04/22/2005 02:29 PM	0.010
HPS To ASCII	04/22/2005 02:29 PM	0.010
HPS to GSF	04/22/2005 02:29 PM	0.010
HPS to HOB	04/22/2005 02:29 PM	0.010
HPS to HTF	04/22/2005 02:29 PM	0.010
Image To Image	04/22/2005 02:29 PM	0.010
HPS to HIPS	04/22/2005 02:29 PM	0.010

www.caris.com

This will launch the Export Wizard. There are various export options available. Data, grids, and images can all be exported using this wizard.

The BASE Surface generated in HIPS can be exported to image file or ASCII file. The user can specify the units for the exported depth values and additional sounding information can also be exported as optional attributes.

The depth can be exported as an ASCII file.

4.3 Generic Mapping Tools (GMT)

Generic Mapping Tools (GMT) (Wessel and Smith, 1998) is a collection of open source mathematical and mapping routines for use on gridded data sets, data series, and arbitrarily located data. The GMT package is available for download from the University of Hawaii website (<http://gmt.soest.hawaii.edu/>).

4.4 r2v, Surfer, Global Mapper

Contributed by John Hall, Geological Survey of Israel (Retired), Israel

Recent compilations of the Caspian Sea and the Red-Arabian Seas illustrate the preparation of high resolution grids using the r2v (www.ablesw.com), Global Mapper 12 (www.globalmapper.com), Surfer 9 (www.goldensoftware.com) software.

An overview of each of the packages follows:

4.4.1 Able Software Corporation's r2v (raster to vector)

A license for r2v costs \$395 for an academic user, or \$795 for non-academic (www.ablesw.com/rv2/price.html). A USB dongle is now employed. As used for bathymetry, a scanned map is geo-referenced, either using Global Mapper (more convenient), or r2v. Once a .tfw (true world file) exists, r2v can work in map coordinates, which are usually Mercator. Very few of r2v's capabilities are used for this work. Mainly the automatic line following is used, following conversion to grayscale, and then contrast selection to accentuate contours while eliminating background. The program will rapidly follow a line until a gap or branch is encountered. One then toggles to manual mode, passes the obstruction, and continues in automatic mode. The program gives complete control over the nodes, adding, moving, smoothing, deleting, and joining. Use of the F2 and F3 keys allows almost unlimited magnification for very steep slopes. Navigation across the map is very easy. Contour values are easy to apply, either individually, or by identifying a beginning value and increment and then drawing a line across sequential contours. For complicated contours it is possible to color code the contours. Output of r2v is generally via a .dxf vector file, or as .xyz points, although other formats are available. The program is also able to digitize points, but each point requires a

number of steps. Dr. Ted Wu is the owner of Able Software and readily answers questions. A trial version of r2v can be downloaded.

4.4.2 Global Mapper Software LLC - Global Mapper 12

A license for Global Mapper 12 is \$349 (www.bluemarblegeo.com), and somewhat less expensive for multiple licenses. Global Mapper was started in 1991 by Mike Childs, who is very responsive to additions and modifications to the program, which undergoes regular improvements. In short, GM12 is a comparatively easy to use program which deals with a wide variety of raster images, grids and vectors, especially those available on the Internet. It deals with a continually increasing number of projections and datums, as well as formats, and allows speedy conversion between them. For our purposes, GM12 allows rapid geo-referencing of charts, rapid TIN display of .xyz files prepared by r2v, projection change of .dxf files, rapid display of multiple grids, superposition of various raster and vector layers, highspeed input of grids (ASTER-GDEM, SRTM, SRTM30-Plus, GEBCO_08, IBCAO etc.), and their manipulation (cropping, clipping, translation, scaling, offsetting etc.). Global Mapper has a tight non-lossy grid format (.gmg).

Global Mapper also offers display and logging of GPS data, draping of imagery or maps on grids with 3-D display, digitization tools, contouring, view-shed and water-shed analysis, screen capture, topographic profiles with slopes, palette construction, shading options etc. It has also become an important connectivity and display tool for sophisticated multi-platform users of programs such as GMT, ArcGIS, CARIS, and IVS Fledermaus. Two features lacking on Global Mapper are the ability to convert .dxf files to xyz (which can be done with the free program [dxf2xyz](http://www.guthcad.com) from www.guthcad.com), and the use of degrees minutes and seconds for geographic coordinates output to .csv format. This is important for merging new digitized contours and shorelines with the spot soundings digitized years ago, to form a single file for interpolation by Surfer. The work-around of course is to use Cartesian meridional parts for Mercator maps, or else UTM coordinates.

4.4.3 Golden Software Inc. Surfer® Version 9

A license for Surfer's latest version 9 is \$699. Global Mapper has the 3-D display, contouring and hypsometric shading and palette selection capabilities of Surfer. However Surfer is the program of choice for interpolation of grids from the tens of thousands of points generated by r2v and the historical digitization of soundings. The Surfer gridding interface allows rapid investigation of the input files, and the Filter Data function deals with duplicates as well as averaging points that are so close that steep gradients would be formed.

Grid Construction

As an example, over 55% of the Mediterranean has now been mapped with multibeam sonar. The MediMap Group (<http://www.ciesm.org/marine/morphomap.htm>) has pooled their data and it is currently available within the group at a node spacing of 500 m. Efforts to decrease this spacing has apparently been opposed by commercial interests. Basically this coverage is sufficiently good to make a first pass at a 0.1' grid for IBCM-II. Israel is now concluding a decade of pro-active mapping with a Kongsberg-Simrad EM1002 owned by John Hall, installed on the Israeli government vessel R/V Etziona. Over 10,000 km² of the Mediterranean offshore have been surveyed, from minimum depths of 15 m to about 700m with the EM1002, and then recently out to 1,600 m depth with a rented L-3 ELAC GmbH SB3050 system. While the Israeli government regards the digital data as classified, grids of 100 m on the shelf and 50 m in deeper waters are available. Hopefully this will encourage other countries to allow use of higher definition deep water data.

The seas that are of interest follow, in order of size etc.:

Water Body	Total Area	Max Depth	Shoreline	Countries
Mediterranean	2,966,000 km ²	5267 m	46,000 km	22
Red Sea	438,000 km ²	2211 m	11,254 km	8
Black Sea	474,000 km ²	2206 m	4,340 km	7
Caspian Sea	371,000 km ²	1025m	6,397 km	4
Persian Gulf	251,000 km ²	90 m	3,334 km	8

Russian charting at about 1:200,000 covers the periphery of all these bodies. Thus grids can be obtained by first taking the land coverage at 30 m from the latest ASTER-GDEM. These come in one degree squares (called granules) and can be downloaded, up to 2000 at a time, from <http://reverb.echo.nasa.gov>. It is necessary to register, and after choosing and verifying the coverage wanted, one receives a verification and link to an ftp site. The granules can be quickly downloaded with an ftp client program like Filezilla (<http://filezilla-project.org>). The files consist of the height values (.dem format) and the number of scenes used (.num). Global Mapper 12 will rapidly ingest the height data while ignoring the .num component, and can then output single .gmg grid files with the data for the overall area. The next step is to remove the data over the sea. This can be done by using Tools>Control Center> Options>Alter Elevation Values to reject anything below 0.1 m. While this will generally work, sometimes the alternative is to single out specific granules and crop them using an area boundary in Global Mapper or a blanking file in Surfer. Such a file is usually the 0 m contour from the digitizing done in r2v.

The clipped ASTER-GDEM file gives a pretty good indication of where the land is, and for checking the marine data which often is pre-WGS84 or WGS72 datums. Older Russian charts sometimes referred to the Russian Pulkovo S42 datum of 1942, or in the case of early British surveys, relative to one of the 700 datums used in UKHO surveys. Global Mapper's ability to overlay and translate charts can correct some of these geodetic displacements.

The next step is to geo-reference the 300 dpi color scans of the charts, one at a time, using Global Mapper. The georeferencing can be checked by bringing up Tools>Configure>General>Grid Display>Lat/Long Grid and specifying the map graticule interval. Visual inspection will then indicate the quality of the georeferencing. General four

corner control points will suffice, but for a long body like the Red Sea, perhaps as many as 20 points may be necessary. Using File>Export Raster Image Format>GeoTiff allows export of a GeoTiff with .tfw true world file that can be used in r2v. At present 92 different projections can be used. Generally it is best to use Cartesian coordinate like meridinal parts or UTM.

Within r2v the coastline and available contours are digitized and their depths noted. Where inset charts at larger scale are available, the spot soundings were separately digitized, and data from them can be digitized separately and then later merged by loading the larger scale .dxf contour file into the smaller scale chart. Where necessary, spot soundings can also be picked up. In order to seamlessly place the bathymetry under the land coverage, the high elevations shown on the navigational chart may be digitized so that the kriging process will apply a landward slope commensurate with the actual topography. Inshore contours at 3, 6, 10, 20, and 50 m are often almost continuous, so that the shallows are reasonably well represented. For the southern Red Sea, where there are numerous reef areas indicated from space imagery, fictitious contours at 20 and 3 m depths help to define the reefs. In general, where ships travel, the hydrographers have soundings, but of course, regardless of what the final grid spacing is, the results must be clearly marked as "Not To Be Used For Navigation."

Coastal navigational charts generally overlap one another, so if each is digitized and then interpolated to a grid, their grids can later be cropped and stacked appropriately within Global Mapper for output as the final grid. In the case of the Red Sea, UTM grids were interpolated at 100 m for Zones 36 and 37. Global Mapper keeps the grids at the finest scale used, so with ASTER-GDEM 30 m data the default output would be 100 m.

REFERENCES

- Carron, M. J., P. R. Vogt, and W.-Y. Jung. 2001. A proposed international long-term project to systematically map the world's ocean floors from beach to trench: GOMaP (Global Ocean Mapping Program). *Int. Hydrographic Rev.*, 2, p. 49–55.
- Doytsher, Y., and Hall, J. K., 1997. Gridded affine transformation and rubber-sheeting algorithm with FORTRAN program for calibrating scanned hydrographic survey maps. *Computers & Geosciences*, 23(7), p. 785-791.
- Hardy, R. L., 1971. Multiquadric equations of topography and other irregular surfaces. *J. Geophys. Res.*, 76(8), p. 1905-1915.
- Hall, J. K., Schwartz, E., and Cleave, R. L. W., 1990. The Israeli DTM (Digital Terrain Map) Project. In: *Microcomputer Applications in Geology, II* (J. T. Hanley and D. F. Merriam, eds.). pp. 111-118.
- Computers and Geology, Vol. 6, Pergamon Press, New York. Computer program on diskette as part of the COGS (Computer Oriented Geological Society) public-domain library.
- Hall, J. K., Udintsev, G. B. and Odinokov, Yu. Yu., 1994. The bottom relief of the Levantine Sea. In: *Geological structure of the North-eastern Mediterranean (Cruise 5 of the Research Vessel*

'Akademik Nikolaj Strakhov'). (V. A. Krasheninnikov and J. K. Hall, eds.), p. 5-31. Historical Productions-Hall, Jerusalem, April 1994.

Vogt, P. R., W. -Y. Jung, and D. J. Nagel, 2000. GOMaP: A matchless resolution to start the new millennium. Eos Transactions, American Geophysical Union, 81(23), p. 254, 258. June 6, 2000.

Chapter 5.0 Gathering Data

There are many types of geophysical data available for free download from the internet. In this chapter we show where to obtain data useful for researchers desiring to create grids from publicly available bathymetric data.

5.1 NCEI and IHO DCDB Bathymetry Data

Contributed by Susan McLean, National Geophysical Data Center, USA

The National Centers for Environmental Information's (NCEI, formerly NGDC) mission is to provide long-term scientific data stewardship for marine geology and geophysical data, ensuring quality, integrity, and accessibility. This includes archiving and making available bathymetric data collected by NOAA, UNOLS (University-National Oceanographic Laboratory System), other US government agencies, and foreign entities. These data include ocean multibeam and single beam surveys, coastal multibeam and single beam surveys (hydrographic surveys), and digital elevation models compiled from various data sources. NGDC is co-located with the International Hydrographic Organization Data Center for Digital Bathymetry (IHO DCDB) which serves IHO member states and the international community by archiving and providing access to global bathymetric data.

Both Centers provide ancillary data files essential to bathymetric data processing. These files include metadata records, sound velocity profiles, navigation files, tides files, and ship logs. When provided by the chief scientist, survey derived products are also made available. However, the bulk of data archived and available to the public are raw multibeam files.

Availability of the raw data allows scientists to edit the data to any specification. Raw multibeam data require a multibeam reader/editor to produce products which are more widely interoperable. Since manipulating the raw data files can be time consuming, the centers offer products which are already edited and in a format readable by many desktop applications. One such product is the Bathymetric Attributed Grid (BAG) file. [BAG \(http://www.opennavsurf.org\)](http://www.opennavsurf.org) is a gridded, multi-dimensional bathymetric data file.

5.1.1 Discovering and Identifying Data

NCEI's [Bathymetry Data Viewer \(http://maps.ngdc.noaa.gov/viewers/bathymetry\)](http://maps.ngdc.noaa.gov/viewers/bathymetry) (Figure 5.1) is an interactive mapping application that allows discovery, identification, and access to bathymetry data archived at NCEI. Here we describe how to interact with the map to identify and obtain data from the NCEI website.

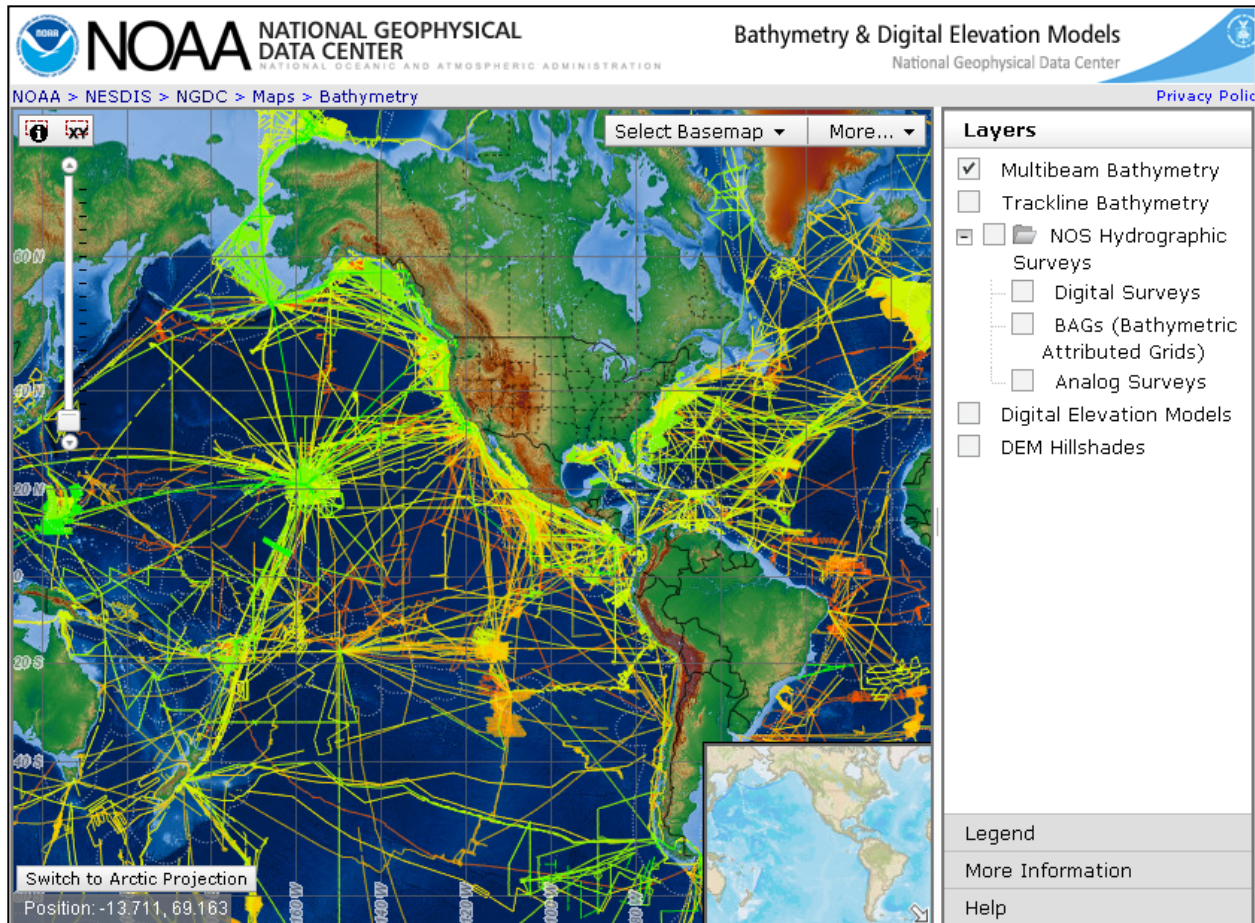

Figure 5.1 NCEI Bathymetry Data Viewer, displaying Multibeam Bathymetry Surveys. Surveys are color-coded by year (newer surveys are green and older surveys are orange).

Navigating the map:

Click and drag to pan the map.

Use the zoom slider to zoom in/out, or shift-click and drag to zoom into a box.

Toggle the different basemaps with the “Select Basemap” drop-down menu.

Toggle the boundaries/labels and graticule with the “More...” drop-down menu.

Switch to an Arctic map projection with the button in the lower-left.

Toggle the various data layers with the checkboxes in the right panel. The available layers are:
Multibeam Bathymetry surveys (shown in Figure 5.1)

Trackline (single-beam) Bathymetry surveys (shown in Figure 5.2)

NOS Hydrographic Surveys for U.S. near-shore areas. The user can toggle Digital Surveys, Analog Surveys, and Bathymetric Attributed Grids (shown in Figure 5.3)

Digital Elevation Models (shown in Figure 5.4)

DEM Hillshades: shaded-relief visualization of DEMs (also shown in Figure 5.4)

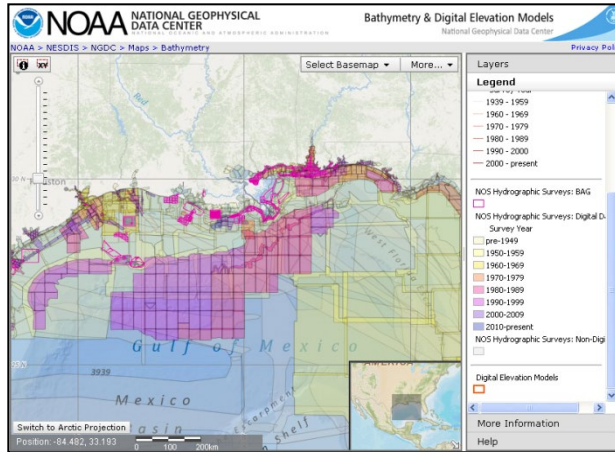

Figure 5.2 Trackline Bathymetry Surveys

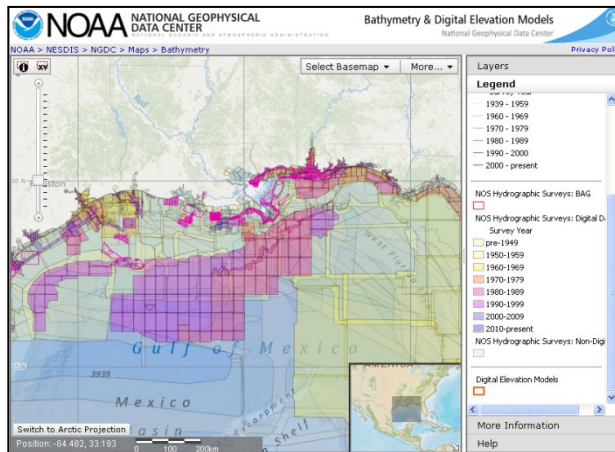

Figure 5.3 NOS Hydrographic Surveys

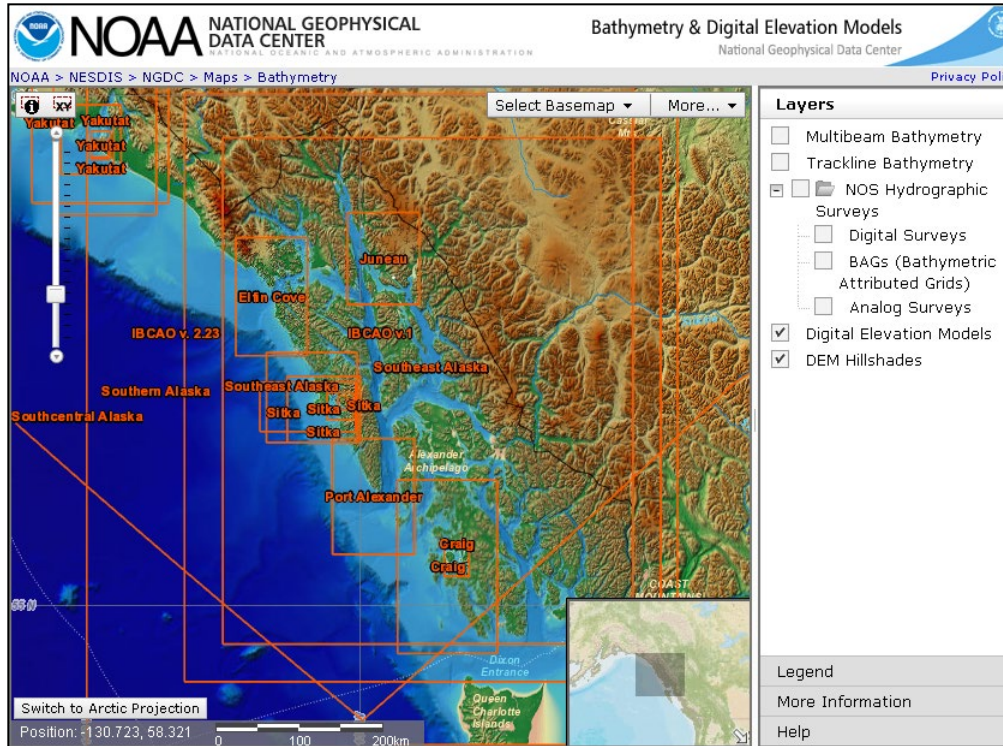



Figure 5.4 Extents of Digital Elevation Models, with shaded-relief visualizations.

Identifying data:

Click on the map to identify data at the point clicked.

Alternatively, a user may define a rectangular area using the  tool to draw a box on the map, or the  tool to define a latitude/longitude extent.

A popup will appear, displaying data near that location (Figure 5.5).

Multiple surveys may be returned near where user clicks; mouse over the list to highlight the surveys on the map.

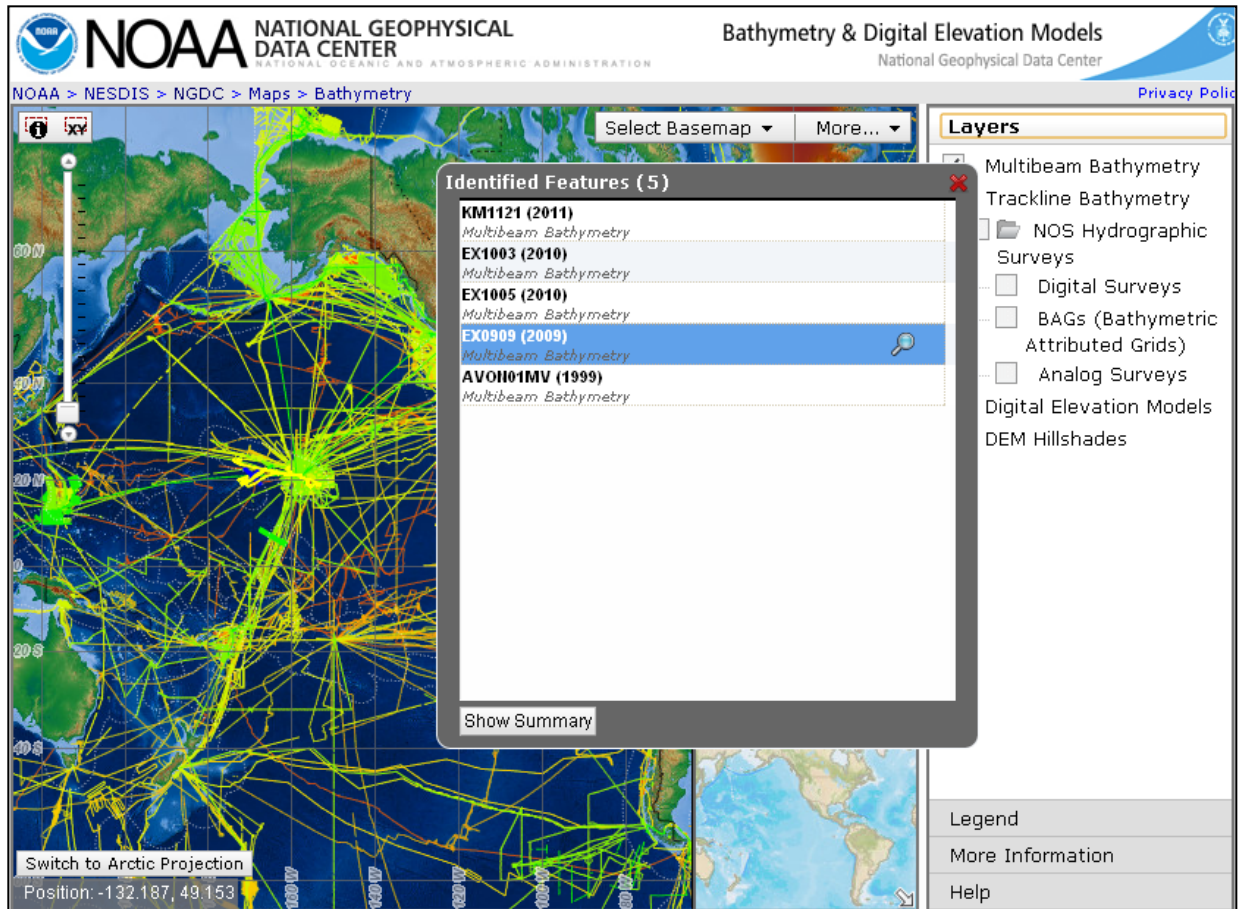

Figure 5.5 After clicking near the Hawaiian Islands, 5 surveys have been identified. EX0909 is highlighted on the map.

Zoom to the extent of a survey using the magnifying-glass icon.
Click “Show Summary” to view a summary of all surveys in the list.

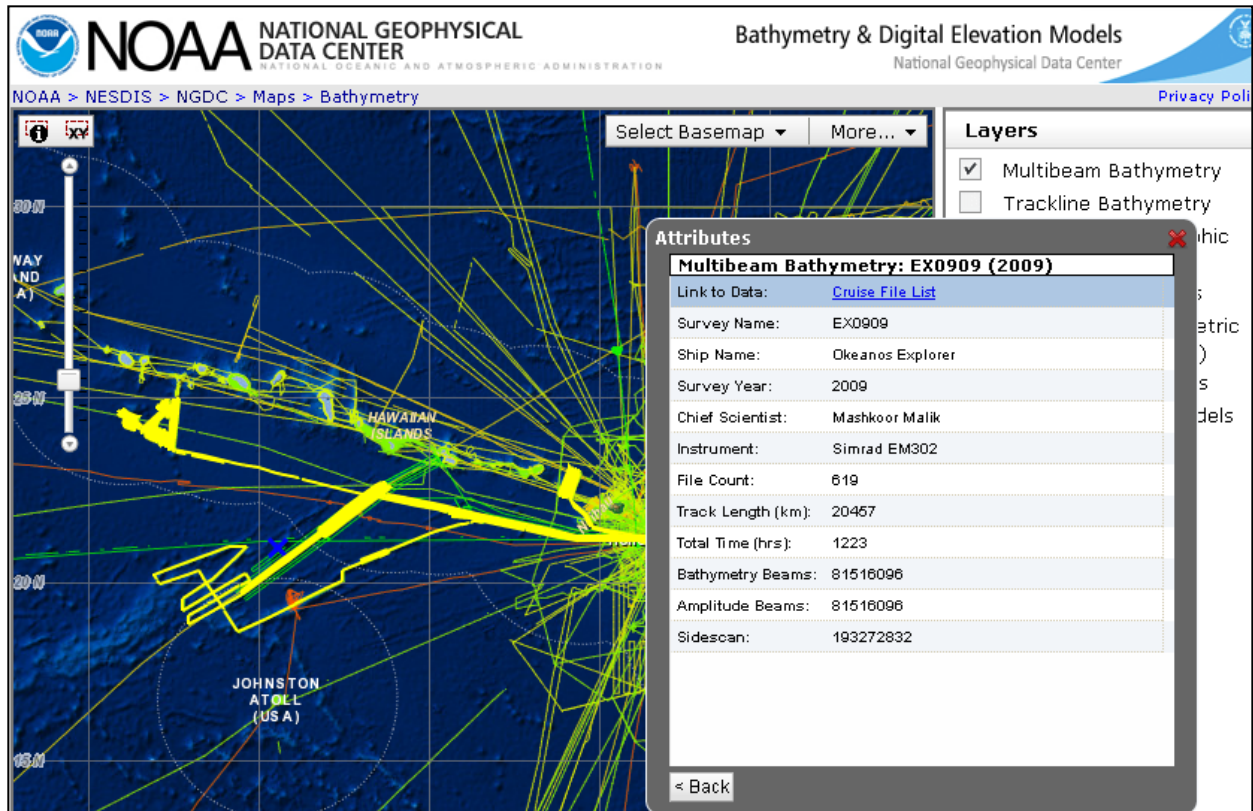

Figure 5.6 Attributes shown for survey EX0909. For multibeam surveys, click on “Cruise File List” to go to a page where data can be downloaded (described below).

Click on a row to display additional attributes for that survey (Figure 5.6). A user can follow the link to go to a page where the data can be downloaded.

Downloading Data:

After clicking the download link from the map, a list of Multibeam data files is shown (Figure 5.7) and can be downloaded either individually, or as one large package. Shown below are download pages for NOS Hydrographic Surveys (Figure 5.8), Trackline Bathymetry (Figure 5.9), and Digital Elevation Models (Figure 5.10).

EX0909 Data File List

These data are not to be used for navigation.

Downloads may take a long time, depending on file size and data transfer rates.

[Download All Files](#) <---Click here to package and download all files listed below

File Name (click to view/download)	File Size	Description
<i>Multibeam Files ---- MBSYSTEM Cruise Summary</i>		
<i>Version 1 Full Resolution----</i>		
0000_20090822_210611_EX.mb58.gz	164.4 MB	Simrad multibeam format
0000_20090825_214655_EX.mb58.gz	84.6 MB	Simrad multibeam format
0000_20090826_060627_EX.mb58.gz	75.7 MB	Simrad multibeam format
0000_20090831_215444_EX.mb58.gz	29.4 MB	Simrad multibeam format
0000_20090912_214507_EX.mb58.gz	241.3 MB	Simrad multibeam format
0000_20090915_031554_EX.mb58.gz	75.8 MB	Simrad multibeam format
0000_20090915_183202_EX.mb58.gz	69.0 MB	Simrad multibeam format
0000_20090925_194808_EX.mb58.gz	24.0 MB	Simrad multibeam format
0000_20091002_030850_EX.mb58.gz	322.7 MB	Simrad multibeam format
0000_20091003_164419_EX.mb58.gz	136.7 MB	Simrad multibeam format
0000_20091003_232450_EX.mb58.gz	26.4 MB	Simrad multibeam format
0000_20091007_160407_EX.mb58.gz	9.6 MB	Simrad multibeam format

Figure 5.7 Multibeam Data download page.



Survey Product List

These data are not to be used for navigation.
For navigation please refer to [NOS Nautical Charts](#).

Downloads may take a long time, depending on file size and data transfer rates.

File Name (click to view/download)	File Size	Description
FGDC Metadata ----		
gov.noaa.nos:H11272		NOAA/NOS FGDC/RSE metadata record Usually presented as an XML document, which captures the basic characteristics of a data or information resource.
Descriptive Report ----		
H11272.pdf	3.1 MB	NOAA/NOS Descriptive Report in PDF format The report may be viewed using a free Adobe Reader.
Bathymetry Attributed Grid (BAG) ----		
<input type="checkbox"/> Select / Unselect All BAG files for conversion to XYZ text format. <input type="checkbox"/> Check here to include Uncertainty Data <input type="button" value="Select Data"/>		
<input type="checkbox"/> H11272_10m_Combined_MLLW_3of3.bag.gz	12.4 MB	NOAA/NOS Bathymetry Attributed Grid (BAG) file The BAG is a gridded, multi-dimensional bathymetric data file. (http://www.opennavsurf.org/). Free Viewer
<input type="checkbox"/> H11272_10m_MLLW_2of3.bag.gz	10.2 MB	NOAA/NOS Bathymetry Attributed Grid (BAG) file The BAG is a gridded, multi-dimensional bathymetric data file. (http://www.opennavsurf.org/). Free Viewer

Figure 5.8 NOS Hydrographic Survey download page. BAG files are available for this survey.



* DATA SEARCH * Survey: SI933001 KEY:GE174122 2011/12/14

DATABASE: Marine Trackline Geophysics Data

searching for analog and digital data

Geophysical Data Summary in nautical miles

Survey	Nav	US Navy Naval Oceanog			ss/ref	m77-recs	data
		Bath	Mag	Grav Seismics			
SI933001	8910	8720	8310	0	8910	0	9650 data metadata plot

GEODAS Search Complete!

1.2 Megabytes needed to store standard MGD77 data from this SEARCH

[Digital Data with Format Options](#)

[disclaimers](#) | [questions](#)

Website of the US Dept of Commerce/NOAA/NESDIS/NGDC, last update Jan 10, 2006
page maintained by: Dan.R.Metzger@noaa.gov

Figure 5.9 Trackline Bathymetry data download page (GEODAS).



[Start New Search](#)

Santa Monica, CA 1/3 arc-second MHW DEM

The Santa Monica MHW DEM covers the coastal area surrounding Santa Monica, California including the communities of Los Angeles, Malibu, Marina del Rey, Redondo Beach, Long Beach, and Huntington Beach. The coordinate boundaries are 117.80° to 119.14°W and 33.20°N to 34.20°N.

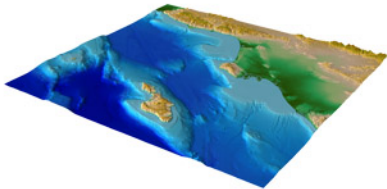

<i>Name</i>	Santa Monica																									
<i>States</i>	California																									
<i>Region</i>	West Coast																									
<i>Extent</i>	<table border="0" style="margin-left: 20px;"> <tr> <td></td> <td></td> <td style="text-align: center;">34.2</td> <td></td> <td></td> </tr> <tr> <td></td> <td style="text-align: center;">N</td> <td></td> <td style="text-align: center;">E</td> <td></td> </tr> <tr> <td style="text-align: center;">-119.14</td> <td style="text-align: center;">W</td> <td style="text-align: center;">+</td> <td style="text-align: center;">+</td> <td style="text-align: center;">-117.8</td> </tr> <tr> <td></td> <td style="text-align: center;">S</td> <td></td> <td></td> <td></td> </tr> <tr> <td></td> <td></td> <td style="text-align: center;">33.2</td> <td></td> <td></td> </tr> </table>			34.2				N		E		-119.14	W	+	+	-117.8		S						33.2		
		34.2																								
	N		E																							
-119.14	W	+	+	-117.8																						
	S																									
		33.2																								
<i>Date Completed</i>	2010-03-12																									
<i>Type</i>	Tsunami Inundation																									
<i>Horizontal Datum</i>	WGS 84																									
<i>Projection</i>	Geographic																									
<i>Vertical Datum</i>	MHW (meters)																									
<i>Coverage</i>	Bathy-topo																									
<i>Cell Size</i>	1/3 arc-second																									
<i>Registration</i>	Grid-node																									
<i>Version</i>	1																									
<i>Source</i>	NOAA / NGDC / MGG																									
<i>Project</i>	NOAA Tsunami Inundation																									
<i>Contact</i>	Barry W Eakins @ NOAA / NGDC																									

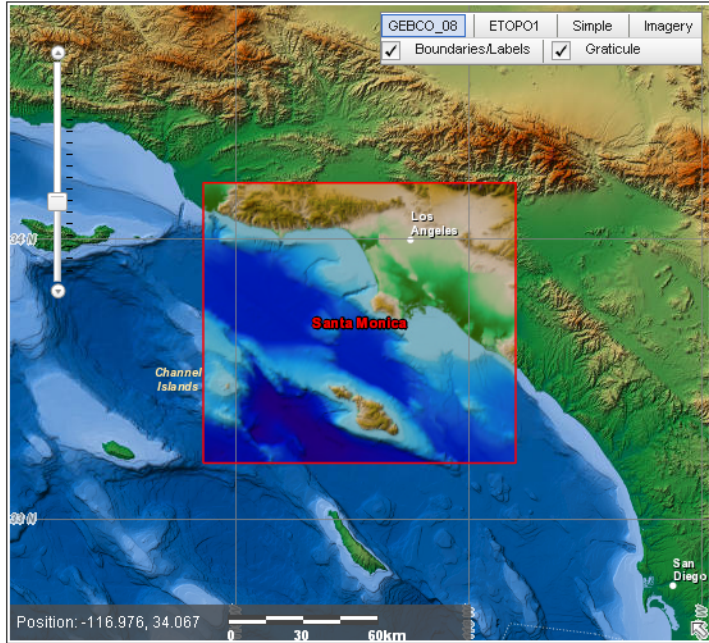

Downloads

- [DEM Development Report \(20.7 MB, pdf\)](#)
- [Santa Monica CA 1-3 arc-second MHW DEM.zip \(490.9 MB, ESRI Arc ASCII\)](#)
- [DEM Metadata Record](#)

Related DEMs

- [Santa Monica, CA 1/3 arc-second NAVD 88 DEM](#)

DEM Restrictions

WARNING: DEM not to be used for navigation.

How to cite this DEM

Please cite the DEM development report.

Figure 5.10 DEM Download Page. Data is provided in ESRI Arc ASCII format.

5.2 JAMSTEC Data

Contributed by K. M. Marks, NOAA Laboratory for Satellite Altimetry, USA

Many types of geophysical data are available for download from the JAMSTEC website (<http://www.godac.jamstec.go.jp/cruisedata/e/>), which is shown in Figure 5.11. Users who make use of the JAMSTEC website are requested to register (click on “User Registration” tab). Here we demonstrate how to obtain multibeam data from the JAMSTEC website.

JAMSTEC Data Site for Research Cruises
JAMSTEC 観測航海データサイト

Japanese

[Data Policy](#) | [JAMSTEC Top Page](#)

[Terms and Conditions](#) | [User Registration](#) | [Application for Data and Samples](#) | [Contact Us](#)

[JAMSTEC Top Page](#) > [Databases](#) > JAMSTEC Data Site for Research Cruises

NATSUSHIMA data archives

KAIYO data archives

YOKOSUKA data archives

MIRAI data archives

KAIREI data archives

Search by Area
(JAMSTEC Data Search Portal)

What's new [Go to list](#)

- 2010/10/08 NT10-13 Leg2 was registered.
- 2010/10/07 KY10-11 Leg1 was registered.
- 2010/10/01 KY10-10 was registered.
- 2010/09/30 YK08-E05: Three component magnetometer data and Gravity data were registered.
- 2010/09/30 NT08-20: XBT data was registered.
- 2010/09/30 XBT data and Bathymetry data were registered. NT08-19, NT08-21 Leg1, Leg2
- 2010/09/30 KY08-09: CTD data and XCTD data were registered.
- 2010/09/30 KR08-11: XBT data, XCTD data, Bathymetry data and Three component magnetometer data were registered.
- 2010/09/30 KR08-10: XBT data, Bathymetry data, Three component magnetometer data and Proton magnetometer data were registered.
- 2010/09/30 YK10-08 was registered.

[Site Policy](#) | [Privacy Policy](#)

Copyright 2008 Japan Agency for Marine-Earth Science and Technology

JAMSTEC 独立行政法人 海洋研究開発機構
JAPAN AGENCY FOR MARINE-EARTH SCIENCE AND TECHNOLOGY

Figure 5.11 JAMSTEC Data Site for Research Cruises.

Multibeam data may be downloaded from the JAMSTEC website as follows. The user first selects the “data archives” link for one of the five research vessels on the main JAMSTEC website (Fig. 5.11). The link opens a global map of cruises color-coded by collection year (Fig. 5.12). The user selects the desired year, and then the cruise ID. Selecting “Apply” opens the individual cruise web page (Fig. 5.13). To reach the bathymetry web page, the user selects “Bathymetry” from the right side of the cruise web page (see Fig. 5.13).

The screenshot displays the 'JAMSTEC Data Site for Research Cruises' interface. At the top, there is a header with the JAMSTEC logo and the text 'JAMSTEC 観測航海データサイト'. A language selector is set to 'Japanese'. Navigation links include 'Data Policy' and 'JAMSTEC Top Page'. A menu bar contains 'Terms and Conditions', 'User Registration', 'Application for Data and Samples', and 'Contact Us'. The main content area is titled 'KAIREI Research Data' and features a 'Selection of Cruise' section with instructions: 'Please choose "Year" of the cruise, and then "Cruise ID"'. Below this are two dropdown menus for 'Year' and 'Cruise ID', and an 'Apply' button. A world map shows cruise tracks for various years (2001-2010) color-coded by year. A right-hand sidebar contains 'About KAIREI' with links for 'Description of the vessel', 'Equipments', and 'Publication list'. The footer includes 'Copyright 2008 Japan Agency for Marine-Earth Science and Technology', 'Site Policy', 'Privacy Policy', and the JAMSTEC logo with its full name in Japanese and English.

Figure 5.12 KAIREI Research Data web page.

JAMSTEC Data Site for Research Cruises Japanese
 JAMSTEC 観測航海データサイト

[Data Policy](#) | [JAMSTEC Top Page](#)

[Terms and Conditions](#) | [User Registration](#) | [Application for Data and Samples](#) | [Contact Us](#)

[JAMSTEC Data Site for Research Cruises](#) > [KAIREI Research Data](#) > KR05-01

KAIREI Data Site : KR05-01

KR05-01
 Period : 05 Jan., 2005 - 24 Jan., 2005
 Chief Scientist : Millard F. Coffin (The University of Tokyo)

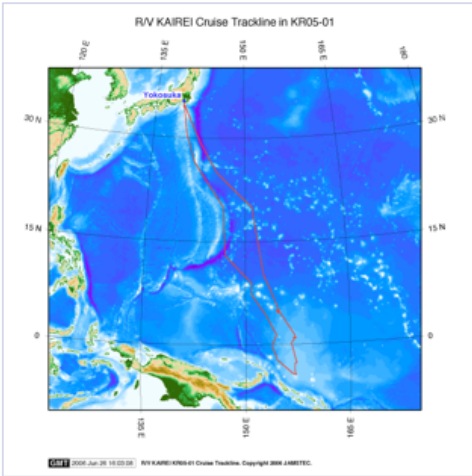

R/V KAIREI Cruise Trackline in KR05-01

© 2005 Jan 20 15:03:38 R/V KAIREI-KR05-01 Cruise Trackline. Copyright 2008 JAMSTEC.

[Enlarge Image](#)

↓ Cruise Report and Data Set

- [PDF Cruise Summary \(Japanese\)](#)
- [Cruise Report](#)
- [Navigation](#)
- [XBT](#)
- [Bathymetry](#)
- [Three component magnetometer](#)
- [Gravity](#)

[Site Policy](#) | [Privacy Policy](#)

Copyright 2008 Japan Agency for Marine-Earth Science and Technology



JAMSTEC 独立行政法人
海洋研究開発機構
JAPAN AGENCY FOR MARINE-EARTH SCIENCE AND TECHNOLOGY

Figure 5.13 KR05-01 Cruise web page.

Bathymetry data may be downloaded from the bathymetry web page (Fig. 5.14) via the “Data” link, as well as information on the instruments, data format, and collection system details (i.e., the “Instruments,” “Format description,” and “Readme” links, respectively). The bathymetry data may be downloaded as a number of compressed files in “zip” format (see Fig. 5.15) that need to be uncompressed (“unzipped”) and then assembled sequentially into a single file. The bathymetry data are ASCII *xyz* (longitude, latitude, depth) multibeam echo sounder ping records. There may not be data along the entire track plot shown on the bathymetry web page and making a plot of the coverage will reveal any gaps.

 **JAMSTEC Data Site for Research Cruises**
 JAMSTEC 観測航海データサイト Japanese

[Data Policy](#) | [JAMSTEC Top Page](#)

[Terms and Conditions](#) | [User Registration](#) | [Application for Data and Samples](#) | [Contact Us](#)

[JAMSTEC Data Site for Research Cruises](#) > [KAIREI Research Data](#) > [KR05-01](#) > Bathymetry Data

KAIREI Data Site : KR05-01 Bathymetry Data Last Modified : 22 Feb., 2008

Processed Data

[Instruments](#) | [Format description](#) | [Readme](#) | [Data](#)

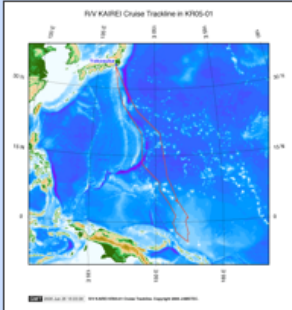

Cruise information

- Period : 05 Jan., 2005 - 24 Jan., 2005
- Chief Scientist : Millard F. Coffin (The University of Tokyo)

[Site Policy](#) | [Privacy Policy](#)

Copyright 2008 Japan Agency for Marine-Earth Science and Technology  **JAMSTEC** 独立行政法人 海洋研究開発機構
 JAPAN AGENCY FOR MARINE-EARTH SCIENCE AND TECHNOLOGY

Figure 5.14 KR05-01 Bathymetry Data web page.

JAMSTEC Data Site for Research Cruises
JAMSTEC 観測航海データサイト

Japanese

[Data Policy](#) | [JAMSTEC Top Page](#)

[Terms and Conditions](#) | [User Registration](#) | [Application for Data and Samples](#) | [Contact Us](#)

[JAMSTEC Data Site for Research Cruises](#) > [KAIREI Research Data](#) > [KR05-01](#) > [Bathymetry Data](#) > Processed Data

KAIREI Data Site : KR05-01 Bathymetry Data : Processed Data

◆ [Data Files](#)

File name : YYYYMMDD.dat
YYYY: year, MM : month, DD: day
* These data are compressed in zip format, please use that after unpacking.

File name	Size	Date
20050106.zip	0.14 MB	06 Jan., 2005
20050107.zip	3.76 MB	07 Jan., 2005
20050108.zip	4.91 MB	08 Jan., 2005
20050109.zip	3.86 MB	09 Jan., 2005
20050110.zip	4.23 MB	10 Jan., 2005
20050111.zip	6.71 MB	11 Jan., 2005
20050112.zip	7.37 MB	12 Jan., 2005
20050113.zip	8.67 MB	13 Jan., 2005
20050114.zip	9.06 MB	14 Jan., 2005
20050115.zip	11.38 MB	15 Jan., 2005
20050116.zip	10.46 MB	16 Jan., 2005
20050117.zip	6.63 MB	17 Jan., 2005
20050118.zip	5.77 MB	18 Jan., 2005
20050119.zip	2.51 MB	19 Jan., 2005

[Site Policy](#) | [Privacy Policy](#)

Copyright 2008 Japan Agency for Marine-Earth Science and Technology

Figure 5.15 KR05-01 Bathymetry Data files available for download.

An alternate way to reach bathymetry web pages is for the user to click on the “JAMSTEC Data Search Portal” tool (see Fig. 5.11). This accesses instructions on how to use the tool as well as provides an entryway to the tool’s ArcIMS interface (see Fig. 5.16). On the ArcIMS interface, the user may drag the red box on the global map (upper left corner) to the desired study location, then select “Quick Search” to drag a box on the main map. This brings up a search result panel (see Fig. 5.17) that lists the cruises that traverse the study box. The bathymetry web page for the cruise of interest can then be reached by clicking on “Jump.”

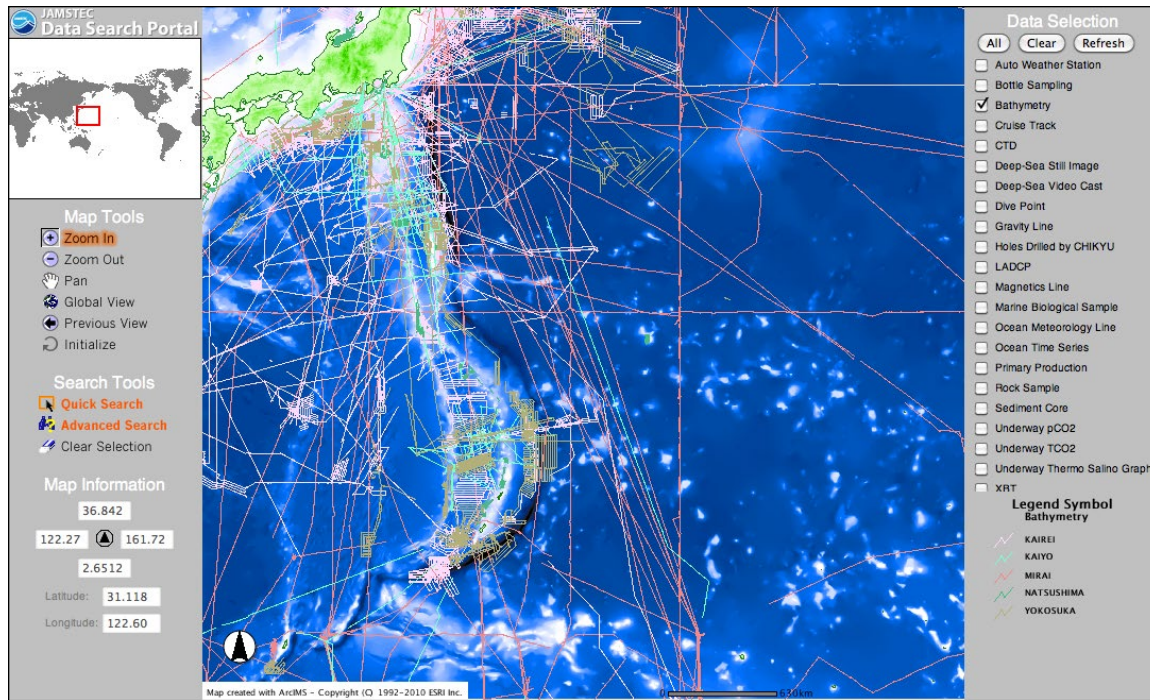

Figure 5.16 JAMSTEC Data Search Portal.

Search Result (Select Data Set : Bathymetry) 16 Selected

No.	Data ID	Latitude	Longitude	Period (start)	Period (end)	Ship Name	Cruise ID	DSRV Name	Dive No.	Web Site
1	0013-0000027			2002/02/20	2002/03/29	MIRAI	MR02-K02			Jump
2	0013-0000035			2003/02/19	2003/03/29	MIRAI	MR03-K01			Jump
3	0013-0000052			2004/11/16	2004/12/08	MIRAI	MR04-07			Jump
4	0013-0000054			2005/01/13	2005/02/18	MIRAI	MR04-08_leg2			Jump
5	0013-0000056			2005/05/24	2005/06/30	MIRAI	MR05-02			Jump
6	0013-0000064			2006/02/04	2006/03/17	MIRAI	MR06-01			Jump
7	0013-0000073			2007/02/15	2007/03/25	MIRAI	MR07-01			Jump
8	0013-0000075			2007/05/30	2007/07/13	MIRAI	MR07-03			Jump
9	0013-0000085			2008/07/01	2008/08/05	MIRAI	MR08-03			Jump
10	0013-0000211			2005/01/04	2005/01/23	KAIREI	KR05-01			Jump
11	0013-0000228			2005/12/09	2005/12/24	KAIREI	KR05-17			Jump
12	0013-0000242			2006/09/11	2006/09/22	KAIREI	KR06-12			
13	0013-0000264			2007/11/22	2007/12/01	KAIREI	KR07-16			Jump
14	0013-0000326			2002/09/29	2002/10/14	KAIYO	KY02-10_leg1			
15	0013-0000639			2001/01/03	2001/01/14	YOKOSUKA	YK01-01			
16	0013-0000915			2009/11/02	2009/12/11	MIRAI	MR09-04			

Figure 5.17 Data Search Portal Results.

Chapter 6.0 Data Cleaning

6.1 Quality Assessment

Contributed by Barry Eakins, NOAA-CIRES, Rob Hare, Canadian Hydrographic Service, and Martin Jakobsson, Stockholm University, Sweden

6.1.1 Sources of uncertainty

Elevation value

Instruments such as multibeam swath sonars and airborne lidar do not actually measure elevation, but rather travel time (of sound or light, respectively). Many different sources therefore contribute to the uncertainty of a calculated depth/elevation value. Although the following text focuses on uncertainties in data acquired with multibeam swath sonar systems, it should be noted that it is in principle applicable to data acquired with any elevation measurement system; a single-beam echosounder is just a special case of a multibeam echosounder (i.e. nadir beam only). Agencies conducting surveys are encouraged to provide uncertainty budgets, or total propagated uncertainty (TPU) estimates for their own systems.

- i. *Sound or light speed uncertainty – how accurately was sensor measurement or time converted into a depth/elevation value?*

Multibeam swath sonar systems rely on frequent measurements of sound speed, typically taken an XBT (expendable bathythermograph) or CTD (conductivity-temperature-depth package), and sometimes measured directly using an SVP (sound speed profiler). These measurements should be taken at least daily, or with changing weather conditions, as longer time intervals decrease the accuracy of the soundings due to improper ray-tracing. Measurements should be taken more frequently in areas of known oceanographic fronts and off the mouths of major rivers.

The sound speed profile is used to calculate depth for each beam, via ray tracing, and is embedded in the binary sonar files. The profiles can be extracted and replaced with different profiles using multibeam processing software such as MB-System, which can recalculate depths and positions for each beam footprint.

Because sound travels farthest for the outermost, lowest grazing angle beams, especially in deep water, and because ray bending increases as the tangent of the beam angle, these beams have the largest depth uncertainty due to sound speed uncertainty caused by ray bending, and often contain anomalous values inconsistent with other, overlapping data. As such, they are frequently flagged for exclusion. If sound speed profiles cannot be taken at a rate which minimizes the uncertainty due to refraction, then line spacing should be decreased in order to increase the overlapping region, and provide additional confidence in the bathymetry with many of the outer beams eliminated from the gridding process.

Uncertainty in the measurement of vessel roll will also contribute significantly to the TPU of depth in the outer beams.

ii. *Position uncertainty – how well known was the position of the sensor?*

With swath sonar systems the distance between the sounding on the seafloor and the positioning system antenna can be very large, especially in deep water. Because of this, sounding position uncertainty is a function of the errors in vessel heading, beam angle solution, refraction correction model and the water depth, in addition to the uncertainty of the positioning system itself.

Roll and pitch errors will also contribute to the uncertainty in the positions of soundings. Overall, it may be very difficult to determine the position uncertainty for each sounding as a function of depth. The uncertainties are a function not only of the swath system but also of the location of, offsets to and accuracies of the auxiliary sensors.

The use of non-vertical beams introduces additional uncertainties caused by incorrect knowledge of the ship's orientation at the time of transmission and at time of reception of sonar echoes.

Uncertainty associated with the calculated depth of an individual swath sonar beam will include the following components:

- a) Positioning system uncertainty (e.g. of the GPS antenna)
- b) Sensor location uncertainty (of the sonar's transducer and hydrophones relative to the GPS antenna)
- c) Beam angle uncertainty (relative to the sensor), including beam steering uncertainty when sound speed at the transducer face is not directly measured
- d) Uncertainty associated with beam detection of seabed reflection echo (angle or time)
- e) Uncertainty in the orientation of the vertical motion sensor (relative to the sonar); pitch bias and roll bias
- f) Vessel motion sensor uncertainty, i.e. roll, pitch and heave
- g) Uncertainty in vessel heading (distinct from path over ground)
- h) Uncertainty associated with the ray path model (including the sound speed profile)
- i) Sensor offset uncertainty (relative to local water level)
- j) Ellipsoidal / vertical datum transformation model uncertainty (if applicable)
- k) Time synchronization / latency between all of the systems

All uncertainties should be combined statistically to obtain a *total vertical uncertainty* (TVU).

Morphologic change since data collection

Morphologic change is an ongoing process that will, over time, decrease the accuracy of survey data. In the coastal zone especially, the movement of sand alters seabed morphology. This may occur as the result of a major storm, or long-term sediment dispersal or accumulation. Regional tectonic uplift or subsidence may also play a role. The older the data is the greater its uncertainty, with the greatest rates of change occurring in shallow water.

Data not measuring ground surface

Not all instrument measurements detect Earth's solid surface. Many individual sonar depths may actually reflect water column noise. Spikes often occur directly along the ship track, where the sound energy returning to the transducer is strongest. Returns from the water surface or from

tree canopy are also common in topographic lidar. These values need to be identified and deleted.

6.1.2 How to determine data uncertainty

a. Typical for modern data types

i. Lidar [*Fugro Earthdata*, 2007]

Point spacing	Vertical accuracy (RMSE)
1 m	0.09 m
2 m	0.20 m
3 m	0.30 m
4 m	0.40 m
5 m	0.51 m

ii. Multibeam swath sonar

iii. Hydrographic surveys undertaken prior to 1998

Depth	Vertical accuracy
< 30 m	0.3 m
> 30 m	1% of depth

b. Estimating navigation uncertainty for older data

c. Comparison with other data

6.2 Data Cleaning Techniques

Contributed by Rob Hare and Paola Travaglini, Canadian Hydrographic Service, and Martin Jakobsson, Stockholm University, Sweden

6.2.1 Automatic (non-interactive) data cleaning

During this stage, the coordinates (i.e. positions and depths) obtained should be controlled automatically by a program using suitable statistical algorithms which have been documented, tested and demonstrated to produce repeatable and accurate results. When selecting an algorithm, robust estimation techniques should be taken into consideration as their adequacy has been confirmed. Many high-density bathymetry processing packages have built-in statistical processing tools for detecting and displaying outliers. Generally speaking, higher-density data sets with large amounts of overlap between lines provide an increased likelihood of detecting blunders. In addition to statistics, threshold values for survey data can be used to facilitate the detection of blunders. Each agency is responsible for the validation of the algorithm used and the procedures adopted.

All blunders and erroneous and doubtful data should be flagged for subsequent operator control. The type of flag used should indicate that it was set during the automatic stage.

6.2.2 Manual (interactive) data cleaning

Following automated processing procedures, there is a requirement for an experienced and responsible hydrographer to review the automated results and validate those results and/or resolve any remaining ambiguities.

For this stage the use of 3-D visualization tools is strongly recommended. Decision making about whether to accept or reject apparently spurious soundings can often be enhanced by viewing combined data sets in three dimensions. These tools should allow viewing the data using a zoom facility. The interactive processing system should also offer different display modes for visualization, e.g. depth plot, uncertainty plot, single profile, single beam, backscatter imagery etc. and should allow for the visualization of the survey data in conjunction with other useful information e.g. shoreline, wrecks, aids to navigation etc. Editing the data should be possible in all modes and include an audit trail. When editing sounding data, it can often be useful to understand the spatial context of the examined data points. What may appear to be bad soundings (blunders) out of context may be recognized as real seafloor artifacts (submerged piles, wrecks, etc.) when viewed in the context of a chart backdrop for example. If feasible, data displays should be geo-referenced. The ability to compare surfaces from newly collected data to ones generated from historical information can often be useful in validating the quality of the new information, or alternatively, for notifying the collecting agency of an unresolved systematic bias that requires immediate attention.

If feasible, these tools should include the reconciliation of normalized backscatter imagery with bathymetry and, provided that automated object detection tools were used, the display of flagged data for both data modes should be possible.

The rules to be observed by operators during this stage should be documented.

The flags set during the automatic stage, which correspond to depths shallower than the surrounding area, should require explicit operator action, at least, for Special Order and Order 1 a/b surveys. If the operator overrules flags set during the automatic stage, this should be documented. If a flag is set by the operator, the type of flag used should indicate this.

It can be helpful to create a map plotting ship track and date/time to assist with correcting anomalies discovered during visualization.

6.2.3 Clipping to polygon or elevation value (e.g., zero)

6.2.4 Common multibeam swath sonar errors

Spikes under nadir

Spikes may be present directly under nadir for many multibeam swath sonar systems, especially older systems. This appears to result from excessive sound energy reflected back toward the sonar and being received in the side lobes of non-nadir beams. Care should be taken when flagging these values as actual seafloor features may appear similar to these spikes.

Tracking water-column noise

Modern multibeam swath sonar systems generally include automated bottom tracking algorithms. Such algorithms search for seafloor echoes in a window centered on the previous (or adjacent) ping's depths. However, the system can begin to track water column noise, and may continue to do so if the system is not actively monitored. Depth variability between pings can be large, the across-track depth profiles are not consistent with seafloor topography, and most of the beams/pings should be discarded.

Roll-over on inward-facing steep slopes

In areas of steep slopes, especially where the seafloor rises towards the sea surface, some sonar systems have a tendency to “roll over” the outermost beams to create a backside or lip. These values must be flagged. These errors can often be detected when editing the data in the context of a priori knowledge of the seabed shape, especially man-made vertical structures or known topography of canyons or fjord walls.

Anomalies on outward-facing slopes

Where steep hills and seamounts are located off ship track, little sound energy from the sonar pulse that strikes the outward-facing slope may be reflected toward the sensor, and the quality of the returning echo is severely degraded. In such cases, the along-track distance between beams is significantly increased, and the variability in depths between pings can be large. Most of these values should be flagged. These types of errors can often be easily discovered when comparing against the overlapping deeper water swaths.

Navigation missing on first ping

In some cases, the first ping of a sonar file may be missing the associated position information supplied by the ship's onboard navigation system. This is generally a time synchronization issue, resulting from the sonar system having not yet received the position from the GPS system. This can be corrected by editing the sonar file's navigation and extrapolating the latitude and longitude backward from subsequent pings.

Inaccurate sound speed profile used

If an inaccurate sound speed profile was used in ray-tracing, the resulting across-track depth profiles tend to tilt upwards on the outermost beams on both sides (“smiles”) or downwards (“frowns”). These data require the application of a better sound speed profile, which might be obtained from other, nearby sonar data, or historical averages for the region. In any event, the uncertainty in the resulting depths is expected to be large, especially on the outermost beams.

Some processing software packages have the facility to modify the observed sound speed profile in order to bend the outer beams of multiple overlapping swaths until a best fit is achieved in the overlap area.

6.2.5 Common lidar errors

Bomb craters

Most lidar data sets contain scattered too-low points, or negative blunders, perhaps produced when a specular reflection or too-close ground saturates the detector and produces an internal echo. If vegetation reflections are removed by a find-the-lowest-point-in-the-vicinity algorithm, true ground points adjacent to the negative blunders may be misidentified as vegetation reflections and removed. The result can be a conical crater that is entirely an artifact. (from [Puget Sound Lidar Consortium](#), 2011).

Vegetation and buildings

First returns in lidar surveys commonly come from the tops of tree canopies, buildings, etc., not ground surface. The lidar data need to be classified, allowing removal of all non-bare earth returns. Some lidar systems provide backscatter intensity values that can be used to validate assumptions about types of ground cover. If geo-registered colour imagery is available, this should also be used to validate assumptions about types of ground cover.

Water-surface values

Lidar surveys (topographic) at the coast are typically flown at low tide for surveying of the inter-tidal zone. As such, water-surface values over the ocean are common, and individual waves may be identifiable. A lidar classification schema may be used to remove these values (water surface returns are generally of low intensity). Alternatively, the data may be clipped to a coastline, though clipping to a high-water coastline may eliminate valid measurements in the exposed inter-tidal zone. As a last resort, edit the data manually by paying attention to where the slope of the inter-tidal zone transitions to wave caps and troughs.

6.3 Data Validation

Contributed by Rob Hare and Paola Travaglini, Canadian Hydrographic Service, and Martin Jakobsson, Stockholm University, Sweden

The final survey data should be subject to independent in-house validation employing documented quality control procedures.

6.3.1 Internal self-consistency

comparison with other survey soundings (e.g., from overlapping swaths) on the same survey

6.3.2 External consistency

comparison with other datasets (e.g., systematic offsets), checklines from independent systems (or vessels, or dates)

6.3.3 Comparison with reported survey specifications

analysis of statistics at cross check points/lines, or in grid cells over flat seafloor, provided a sufficient number of points are available in each cell to compute reliable statistics.

References

Fugro Earthdata, 2007. Lidar Mapping Fact Sheet.

International Hydrographic Bureau, 2008. *IHO Standards for Hydrographic Surveys, 5th ed., Special Pub. No. 44*, Monaco. http://iho.int/iho_pubs/standard/S-44_5E.pdf

Puget Sound Lidar Consortium, 2011. *Lidar artifacts*, Seattle. <http://pugetsoundlidar.ess.washington.edu>

The following has been extracted from 5th Edition, S-44 (2008) Annex B by Rob Hare and edited for context

6.4 Use of uncertainty surfaces

Many statistical bathymetry processing packages also have the ability to generate an *uncertainty surface* associated with the bathymetry using either input error estimates or by generating spatial statistics within grid cells. Displaying and codifying these *uncertainty surfaces* is one method of determining whether the entire survey area has met the required specifications. If some areas fall outside the specifications, these areas can be targeted for further data collection or use of alternative systems in order to reduce the uncertainty to within an acceptable tolerance. When performed in real-time, the sampling strategy can be adapted as the survey progresses, ensuring the collected data are of an acceptable quality for the intended use. Each agency is responsible for the validation of these processing capabilities prior to use.

6.5 Validation Procedures

The final data should be subject to independent in-house validation employing documented quality control procedures.

Chapter 7.0 Metadata Documentation

The following has been extracted from 5th Edition, S-44 (2008) Chapter 5 by Rob Hare and edited for context

7.1 Introduction

To allow a comprehensive assessment of the quality of survey data it is necessary to record or document certain information together with the survey data. Such information is important to allow exploitation of survey data by a variety of users with different requirements, especially as requirements may not be known when the survey data is collected.

7.2 Metadata

Metadata should be comprehensive but should comprise, as a minimum, information on:

- the survey in general e.g. purpose, date, area, equipment used, name of survey platform;
- the geodetic reference system used, i.e. horizontal and vertical datum including ties to a geodetic reference frame based on ITRF (e.g. WGS84) if a local datum is used;
- calibration procedures and results;
- sound speed *correction* method;
- tidal datum and reduction;
- uncertainties achieved and the respective *confidence levels*;
- any special or exceptional circumstances;
- rules and mechanisms employed for data thinning.

Metadata should preferably be an integral part of the digital survey record and conform to the “IHO S-100 Discovery Metadata Standard”, when this is adopted. Prior to the adoption of S-100, ISO 19115 can be used as a model for the metadata. If this is not feasible similar information should be included in the documentation of a survey.

Agencies responsible for the survey quality should develop and document a list of *metadata* used for their survey data.

7.3 Point Data Attribution

All data should be attributed with its *uncertainty estimate* at the 95% *confidence level* for both position and, if relevant, depth. The computed or assumed scale factor applied to the standard deviation in order to determine the uncertainty at the 95% *confidence level*, and/or the assumed statistical distribution of errors should be recorded in the survey’s metadata. (For example, assuming a Normal distribution for a 1D quantity, such as depth, the scale factor is 1.96 for 95% confidence. A statement such as “Uncertainties have been computed at 95% confidence assuming a standard deviation scale factor of 1.96 (1D) or 2.45 (2D), corresponding to the assumption of a Normal distribution of errors,” would be adequate in the metadata.) For soundings this should preferably be done for each individual sounding; however a single uncertainty estimate may be recorded for a number of soundings or even for an area, provided the difference between the individual *uncertainty* estimates can be safely expected to be

negligible. The attribution should, as a minimum, be sufficient to demonstrate that the requirements of these Standards have been met.

7.4 Bathymetric Model Attribution

If a *Bathymetric Model* is required, *metadata* should include: the model resolution; the computation method; the underlying data density; uncertainty estimate/*uncertainty surface* for the model; and a description of the underlying data.

Chapter 8.0 **Gridding Data**

8.1 Introduction to gridding

TEXT IN PREPARATION

8.1.1 *Polynomials*

TEXT IN PREPARATION

8.1.2 *Near-neighbor searches*

TEXT IN PREPARATION

8.1.3 *Triangulation*

TEXT IN PREPARATION

8.1.4 *Splines*

TEXT IN PREPARATION

8.1.5 *Kriging*

TEXT IN PREPARATION

8.2 Examples of gridding methods

8.2.1 *Gridding JAMSTEC multibeam data*

Contributed by K. M. Marks, NOAA Laboratory for Satellite Altimetry, USA

A grid can be formed from the individual multibeam *xyz* points downloaded from the JAMSTEC website (see Figure 5.4). Because there are so many data points it is advantageous to first take

their block average using GMT routine “blockmedian,” calculating the median z (at the x, y location of the median z) for every non-empty grid cell on a 6 arc-second mesh. The next step is to use GMT routine “surface,” an adjustable tension continuous curvature surface gridding algorithm, to form a grid at 6 arc-second spacing in longitude and latitude from the median depths. Routine “grdmask” is then used to create a mask that is applied to the grid using “grdmath” so that it holds values only in cells that contain one or more of the original xyz points. Below we list the GMT routines used to create the grid from KR05-01 xyz multibeam points that is shown in Figure 8.1. We also list the GMT routines used to produce Figure 8.1.

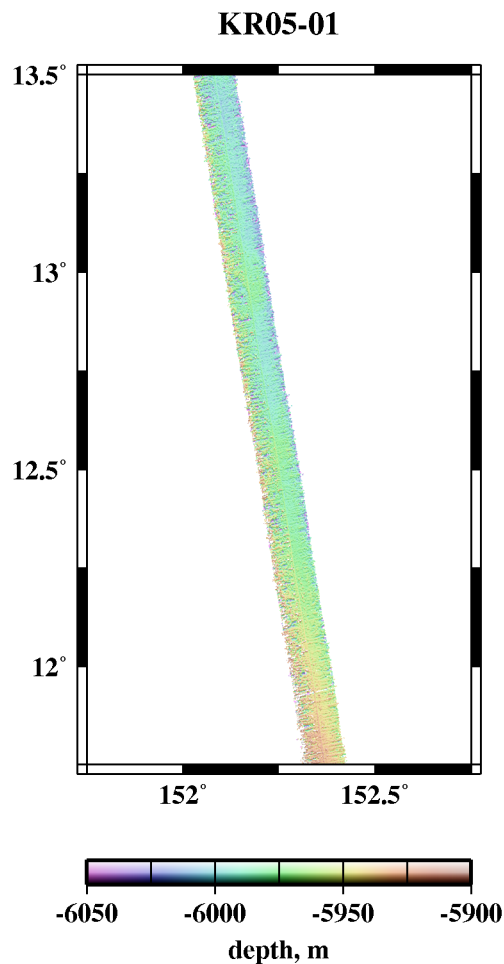

Figure 8.1 Color shaded-relief image of gridded KR05-01 multibeam points. GMT routines that created the grid shown in Figure 8.1:

```
blockmedian KR05-01.xyz -R151.75/152.75/11.75/13.5 -I6c -Q > KR05-01.blockmedian.6c.xyz
surface KR05-01.blockmedian.6c.xyz -R151.75/152.75/11.75/13.5 -I6c -T0.25 -GKR05-01.surf.6c_grd
grdmask KR05-01.xyz -GKR05-01.mask_grd -R151.75/152.75/11.75/13.5 -I6c -NNaN/1/1 -S6c
grdmath KR05-01.surf.6c_grd KR05-01.mask_grd OR = KR05-01.surf.6c.nan_grd
```

Figure 8.1 (above) was produced with the following GMT commands:

```

grdgradient KR05-01.surf.6c.nan_grd -A0 -Ne0.2 -Ggradient_grd
grdimage KR05-01.surf.6c.nan_grd -lgradient_grd -Cmb.cpt -Jm2 -K > Fig.8.1.ps
psbasemap -R151.75/152.75/11.75/13.5 -Jm2 -Ba.5f.25:"KR05-01":WeSn -O -K >> Fig.8.1.ps
psscale -D1/-.5/2/.125h -Cmb.cpt -Ba50g25:"depth, m": -l -N300 -O >> Fig.8.1.ps

```

8.2.2 GMT Surface and Nearneighbor

We used depth values from the constrained grid cells from V12.1* in the study area as input into different gridding algorithms: GMT routine “surface,” employed with the tension set to “0” and set to “1,” and GMT routine “nearneighbor.” Surface tension set to “0” gives the minimum curvature solution, and set to “1” gives a harmonic surface where maxima and minima are only possible at control points. “Nearneighbor” uses a nearest neighbor algorithm to assign an average value within a radius centered on a node. The GMT command lines used to produce the gridding solutions shown in Figure 8.2 are listed below.

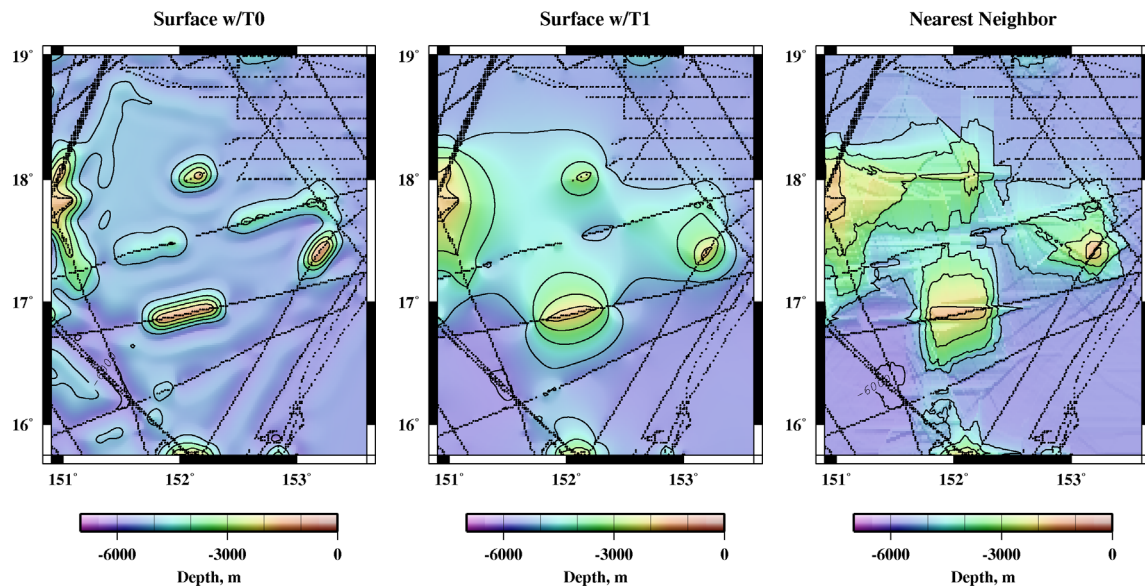

Figure 8.2 Results of gridding depths from V12.1* at constrained grid cells (black dots): GMT “surface” gridding routine with tension set to 0 (left) and set to 1 (middle), and “nearneighbor” gridding routine (right).

Gridding solutions shown in Figure 8.2 were produced with the following GMT commands:

```

img2grd -R149/154/14/19 topo_12.1*.img -Gtopo_12.1*.controls_grd -T2 -m1 -D
surface topo_12.1.nojamstec.controls.xyz -R0/2.7/0/3.41666666667 -l1m -T0 -Gsurface.t0_grd
surface topo_12.1.nojamstec.controls.xyz -R0/2.7/0/3.41666666667 -l1m -T1 -Gsurface.t1_grd
nearneighbor topo_12.1.nojamstec.controls.xyz -R0/2.7/0/3.41666666667 -N4/1 -S100k -l1m
-Gnearneighbor.1m_grd

```

8.2.3 *GMT Triangulate*

TEXT IN PREPARATION

8.2.4 *Spline pyramid*

TEXT IN PREPARATION

8.2.5 *Kriging*

TEXT IN PREPARATION

8.2.6 *Spline Interpolation*

Contributed by Chris Amante and Matt Love, NOAA National Centers for Environmental Information (NCEI)

Spline interpolation estimates elevation values using a mathematical function to create a continuous surface that passes exactly through all input elevations while minimizing the overall squared curvature. Oscillation effects of a minimum curvature surface can be reduced by using tension. The surface can be thought of as a flexible rubber plate that can be adjusted using tension, with a tension of zero corresponding to the minimum curvature surface. Two open-source software programs, the Generic Mapping Tools (GMT; <http://www.soest.hawaii.edu/gmt/>), and MB-System (<http://www.ldeo.columbia.edu/res/pi/MB-System/>), offer spline gridding algorithms, ‘surface’ and ‘mbgrid,’ respectively.

Prior to using GMT’s ‘surface,’ it is recommended that the user pre-process the data with GMT ‘blockmean’, ‘blockmedian’, or ‘blockmode’ to avoid spatial aliasing and to eliminate redundant data. As an example, for two adjacent NOS surveys in xyz format, H10393, and H10394, pre-process the data using ‘blockmedian’. Required user defined parameters include the input xyz file(s), the grid spacing (-I), the region of interest (-R), and the name of the output xyz file. Numerous other options can be specified (See GMT Manual Pages).

GMT ‘blockmedian’ example:

```
blockmedian H10393.xyz H10394.xyz -I1c/1c -R-88.13/-88.02/30.07/30.15 >  
blockmedian.xyz
```

Required user defined parameters for GMT ‘surface’ include the xyz input data, the name of the output binary 2-D .grd file (-G), the grid spacing (-I), and the region of interest (-R). Numerous other options can be specified (See GMT Manual Pages). Most notably, the user can define a tension value between 0 and 1 (-T). A tension value equal to zero indicates a minimum curvature solution.

GMT ‘surface’ example:

surface blockmedian.xyz -Gsurface_example.grd -I1c/1c -R-88.13/-88.02/30.07/30.15 -T0.25

Required user defined parameters for MB-System’s ‘mbgrid’ include the name of the datalist containing a list of the input data files and their format (-I), and the character string to be used as the root of the output filenames (-O). There are numerous other user-defined parameters (See MB-System Manual Pages). Most notably, the user can define the datatype (-A), the distance from the data that the spline interpolation may be applied and the interpolation mode (-C), the grid spacing (-E), the gridding algorithm mode (-F), the format of the output grid file (-G), the region of interest (-R), the tension value between 0 and infinity (-T), and the extension of the internal grid so that the output grid is a subset from the center of a larger grid allowing for data outside of the output grid to guide the spline interpolation at the edge of the output grid (-X).

MB-System ‘mbgrid’ example:

**mbgrid -Igebco.datalist -Ombgrid_example -A2 -C10/2
-E0.00027777778/0.00027777778/degrees! -F1 -G3 -R-88.13/-88.02/30.07/30.15 -T100
-X0.05**

8.2.7 Global Mapper

TEXT IN PREPARATION

8.2.8 r2v

TEXT IN PREPARATION

8.2.9 Surfer

TEXT IN PREPARATION

8.2.10 Gridding in ArcMap

Contributed by Anastasia Abramova, Geological Institute Russian Academy of Sciences, Russia

Here we present step by step example on how to open .xyz space delimited column data in ArcMap and to interpolate data points into a grid of appropriate resolution. As an example .xyz file with Latitude, Longitude and Depth in Geographic projection covering area between 2-11E and 72-74N is used. We would like to create a grid in UTM projection with appropriate cell resolution using Inverse Distance Weighting Interpolation algorithm. The procedure of reprojecting the data, assessing the data density to choose suitable grid size is described. Tools available in ArcMap in order to select optimal interpolation parameters and to compare resultant surface with original data points are discussed. In order to be able to carry out above noted you will need to have Spatial Analyst and Geostatistical Analyst extensions.

Importing .XYZ file in ArcMap

In order to open .xyz file in Arc, you need to modify it: text file needs to have header, data should be comma separated and file name should not have spaces in it.

In order to modify .xyz text file, import it into MS Excel:

- File>Open .xyz
-
- Select Delimiters that you then press Finish

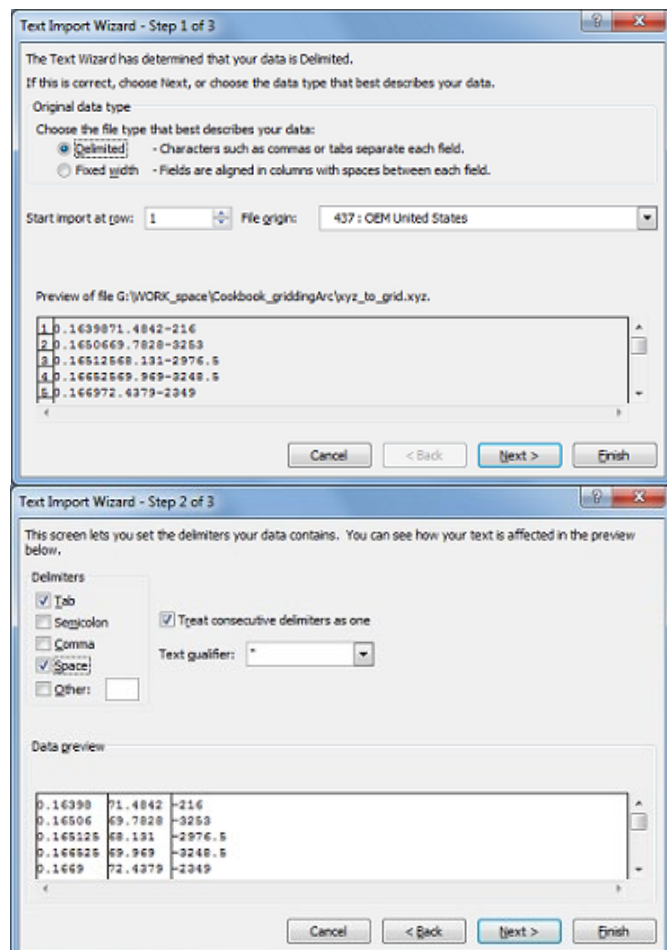

have

- Insert header row, type header name for each column (no spaces!)
- File> Save as .CSV (Comma delimited)
- Close file In MS Excel! (Arc doesn't want to open it if it is opened somewhere else)

	A	B	C	D
1	Latitude	Longitude	Depth	
2	0.16398	71.4842	-216	
3	0.16506	69.7828	-3253	
4	0.165125	68.131	-2976.5	
5	0.166525	69.969	-3248.5	
6	0.1669	72.4379	-2349	
7	0.1679	73.6308	-3081.5	
8	0.16886	72.188	-2339	
9	0.169775	73.5958	-3097.5	
10	0.17001	70.535	-2652	
11	0.170925	72.1687	-2458	

- Open ArcMap: File> New > Blank Document
- Select Add Data from Standard Toolbar (Or go to File> Add Data) and add your .csv file
- To display your data right click on the layer> Display XY Data

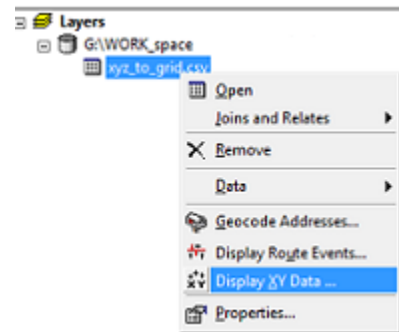
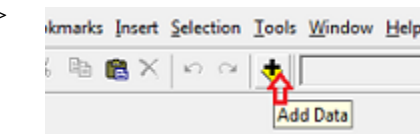

- Select the appropriate fields: X as Latitude and Y as Longitude. In order to define the input data projection: press Edit > Select> Geographic> World > WGS 1984. Press Ok

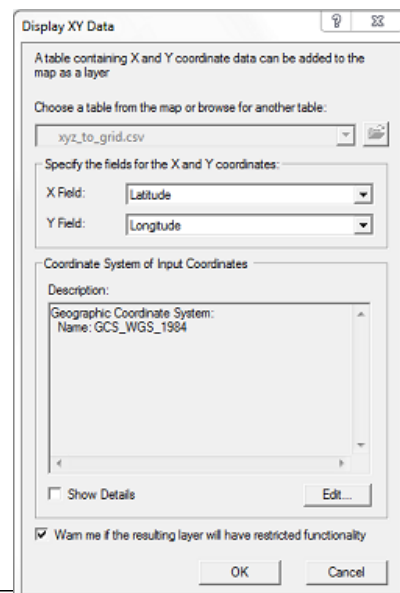

- In order to save file as ArcMap shape file, right click on the layer> Data> Export Data> Save as .shp file

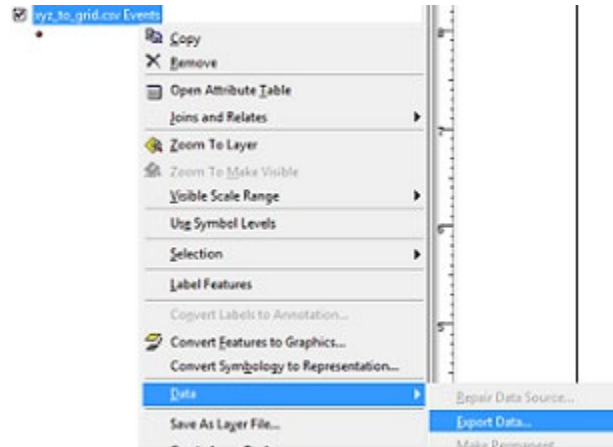

Reprojecting the data

- We would like to create a grid in UTM projection with units in meters, instead of degrees. For that we need to reproject our data.
- Click on Show/Hide ArcToolbox:
- In opened ArcToolbox choose Data Management Tools> Projections and Transformations> Feature> Project

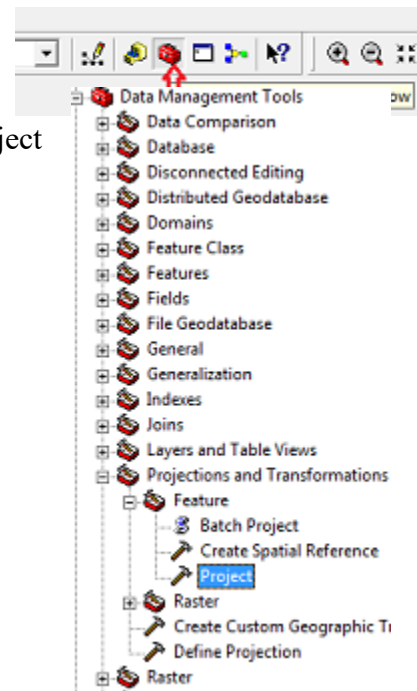

- Define the Input and Output files and Output Coordinate System (In our case it is WGS 1984, UTM Zone 30N). Press Ok.

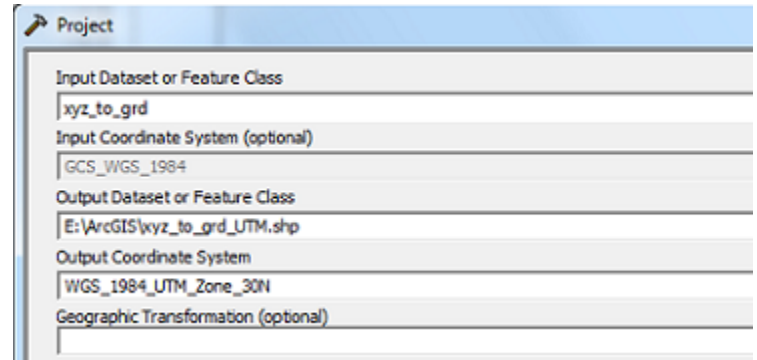

- You might want to change the data frame projection view from Geographic to UTM_Zone_30N now (projection in the data frame view is defined by projection of the first opened file). Right click on Layers> Properties> Coordinate Systems. Select from Predefined list Projected> UTM> WGS 1984> UTM Zone 30N. Press Ok. Now data frame view has the same projection as reprojected file.

- Finally our added data looks like this. As you can notice, the data point density varies over the area



Defining cell resolution for the grid

- The choice of grid resolution depends on your purposes. Meanwhile, data distribution, density, complexity of modeled terrain and scale of the final map should be taken into account as well.
- We would like to create grid with 2 km cell resolution. Here we show how to identify the percentage of cells which values will be defined by interpolation and how to estimate the data density within each cell for the chosen grid size.
- Make sure that Spatial Analyst Extension is activated: go to Tools> Extensions> check Spatial Analyst. Also, add Spatial Analyst toolbar: go to View> Toolbars> check Spatial Analyst.

- From Spatial Analyst toolbar select Convert > Features to Raster

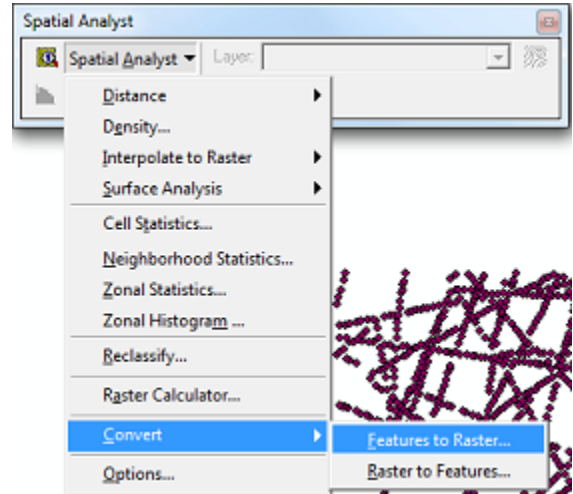

- Select appropriate field and cell resolution:

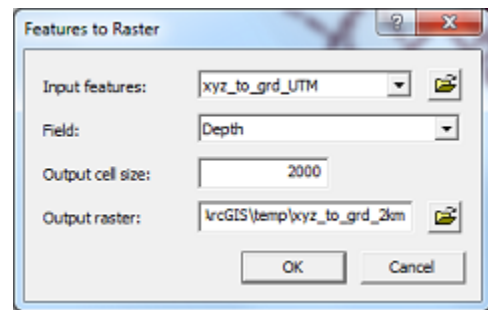

- As you can see, in the created raster, only cells with data points in it have non zero values:

- xyz_to_grd2km
 <VALUE>
 - 3,814 - -3,238
 - 3,237.999999 - -2,914
 - 2,913.999999 - -2,614
 - 2,613.999999 - -2,390.5
 - 2,390.499999 - -2,185
 - 2,184.999999 - -1,908
 - 1,907.999999 - -714

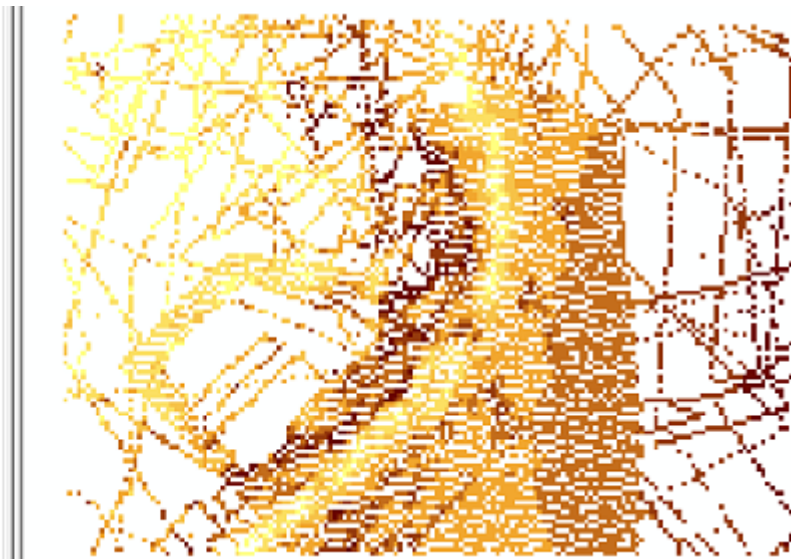

- In order to find out what is the percentage of cells with “no data values”, go to Layer> Properties> Source. Here you can look up the total number of cells in the grid created by multiplying total number of rows by number of columns (157*116=18212)

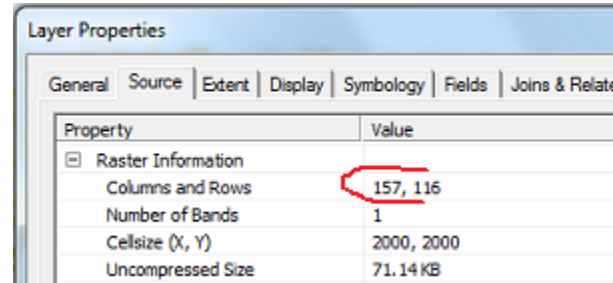

- In order to find out how many cells have non zero values, go to Symbology tab in Layer Properties window and click on Classified. Select Classify tab. The classification table will appear. In Classification Statistics Window, Count will tell the amount of non zero cells (6661). This is approximately 36 % of total amount of cells. Therefore, the values for 64% of cells will have to be estimated by interpolation.

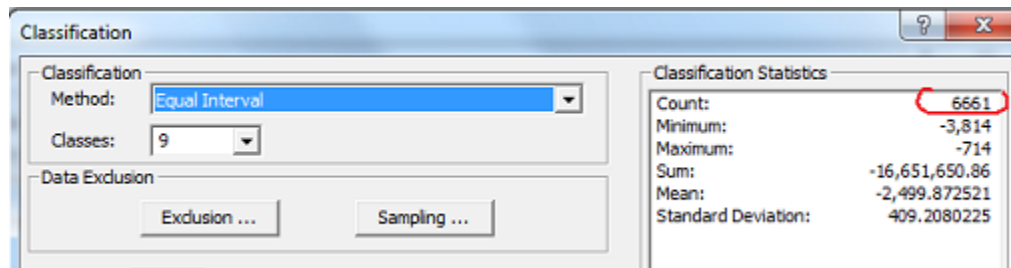

- Now we would like to find out what is the maximum density of data points per cell for the chosen grid size (we don't want it to be too small or too big - although in the end it depends on your purpose).

- From Spatial Analyst toolbar select Density:

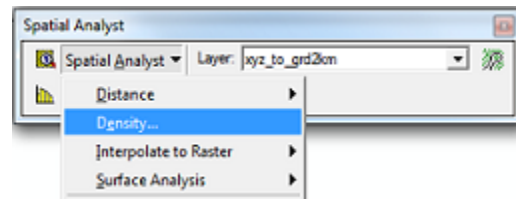

- Leave population field to “None”, define search radius and output cells size in projection units (meters), and desired output area units (square km)
For more information on how the density tools work go to:

http://help.arcgis.com/en/arcgisdesktop/10.0/help/index.html#/An_overview_of_the_Density_tools/009z000000r000000/

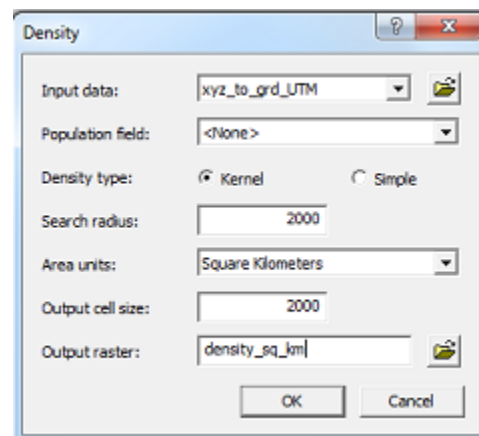

- Calculated result represents density of data points per unit area (squared km) within the neighborhood of defined search radius (2000 by 2000 square meters).
- In order to calculate amount of data points per grid cell of chosen resolution, go to Spatial Analyst toolbar and select Raster Calculator.
- In Raster Calculator syntax is very important. For more information on map algebra rules and on how to use raster calculator:

http://help.arcgis.com/en/arcgisdesktop/10.0/help/index.html#/An_overview_of_the_rules_for_Map_Algebra/00p600000006000000/
<http://help.arcgis.com/en/arcgisdesktop/10.0/help/index.html#/009z000000z7000000.htm>

- We would like to create a new raster layer with the name [point_per_pixel] (put layer name into square brackets and better avoid spaces in the names). We would calculate number of points per cell from the density layer by multiplying it by the area of search radius (2000 by 2000 square meters). Note that units should be the same as units in the density layer: density map was in km squared, therefore we multiply density layer by 2*2 km sq:

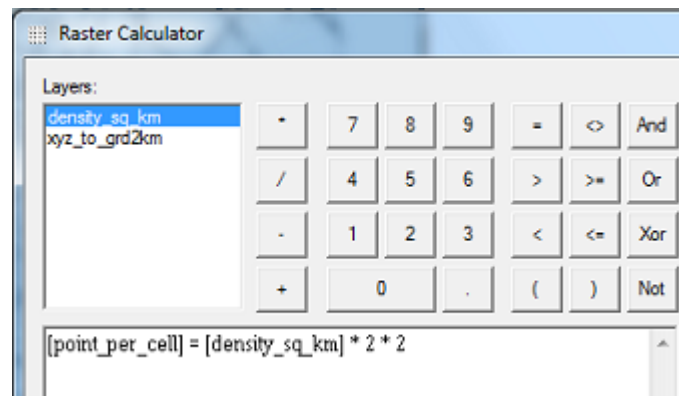

- As a result we get the following raster:

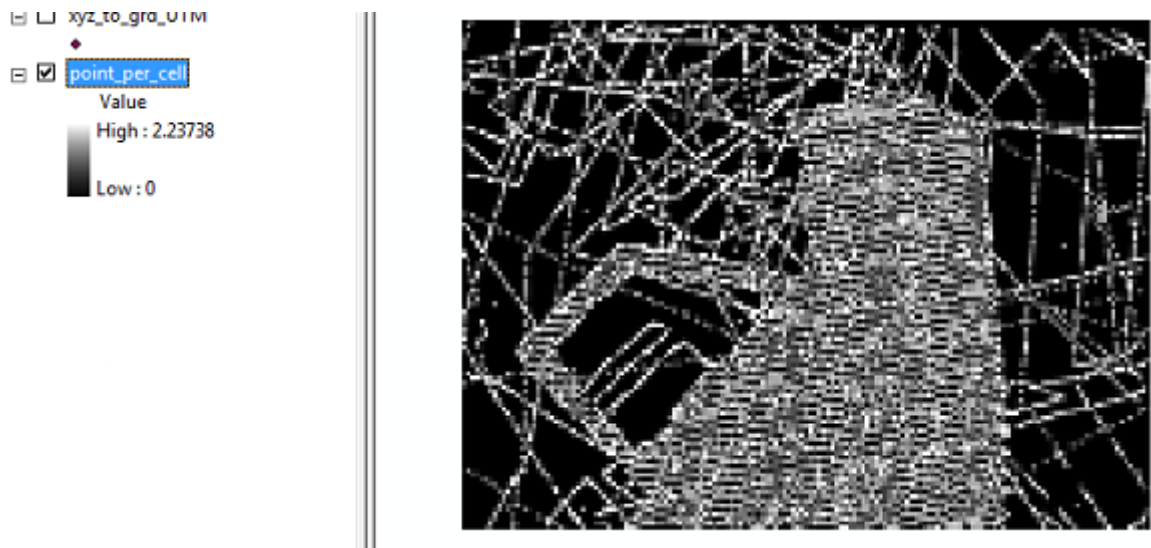

- As you can see, density of points is maximum 2.2 points per grid cell. This can be considered not enough; therefore you might want to change grid size to coarser resolution. We will use this grid spacing in our example.

Creating a gridded surface

- There are several interpolation algorithms available in ArcMap, these include Global and Local Polynomials, Kriging, Spline, Natural Neighbor and Inverse Distance Weighting available within Spatial Analyst and 3D extensions . The description of these interpolation algorithms can be found in other sections of Chapter 8.2. More information on interpolation from point to surface methods can be found:
- http://webhelp.esri.com/arcgisdesktop/9.2/index.cfm?TopicName=An_overview_of_the_Raster_Interpolation_toolset
http://webhelp.esri.com/arcgisdesktop/9.2/index.cfm?TopicName=An_overview_of_the_Interpolation_toolset
- Here we will present how to create a gridded surface using Inverse Distance Weighting (IDW) algorithm. IDW can be a good choice for fast interpolation of sparse data. IDW interpolation predicts values at unmeasured locations according to the values from the surrounding data points. Points which are closer to the prediction location have more influence (weight) on prediction than those which are further away. For more information on IDW see:
- http://webhelp.esri.com/arcgisdesktop/9.2/index.cfm?id=3304&pid=3302&topicname=How_Inverse_Distance_Weighted_%28IDW%29_interpolation_works

- IDW is available through ArcToolbox Spatial Analyst Tools> Interpolation>IDW (or through Spatial Analyst toolbar> Interpolate To Raster> Inverse Distance Weighting). The IDW window will appear.

- As you can see several parameters need to be defined. *Power* defines the distance weight given to each data point in the interpolation process. The higher the power, the faster the weights decrease with distance. *The number of points* defines number of points with known values to be used for prediction of the unknown value.

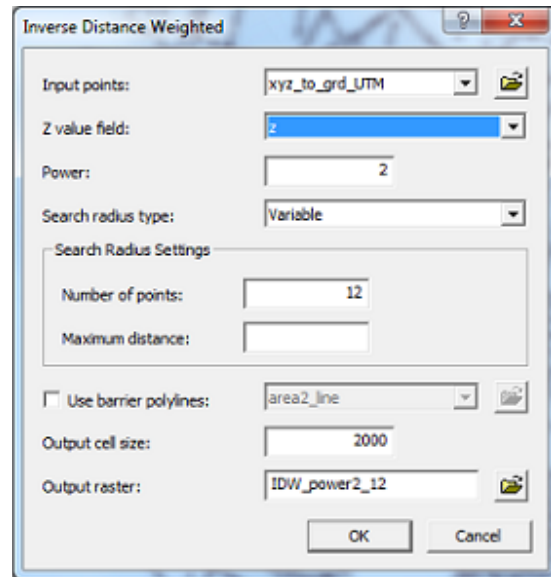

- In order to choose optimal parameters for interpolation, you can use Geostatistical Analyst toolbox. Activate the extension through Tools> Extensions> check Geostatistical Analyst. Also add it to your display through View> Toolbars> Geostatistical Analyst.
- Geostatistical Analyst> Geostatistical Wizard provides cross-validation of your model according to parameters chosen. The wizard allows you to manipulate parameters and to look at the output statistics for the created model. For more information see:

http://webhelp.esri.com/arcgisdesktop/9.2/index.cfm?id=3355&pid=3334&topicname=Performing_cross-validation_and_validation

- In Geostatistical Analyst open Geostatistical Wizard. Select input data point layer and attribute (Depth)

- As an example we will use Power 2.5, and minimum number of points 10. Click next.

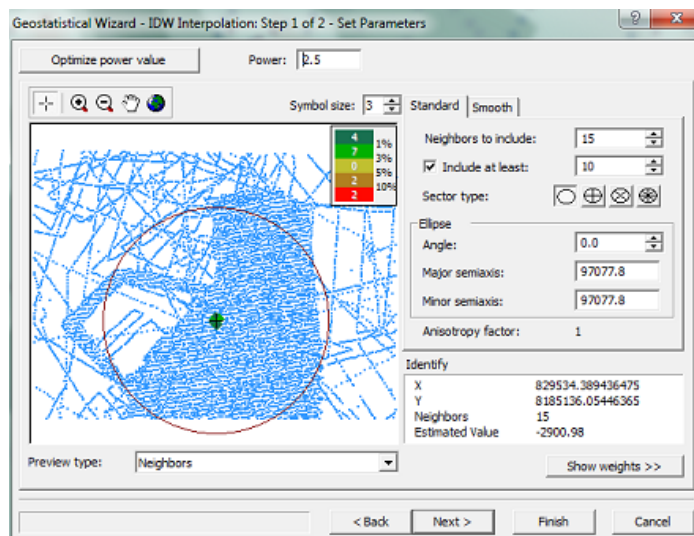

- You can see from the figure below results of our cross-validation. The root mean square error is more than 100 meters. This can be explained by low density of data points (see figure above) and overall uncertainty of depth in the area (average depth of 2000m, with uncertainty of around ... water depth). You can vary interpolation parameters and see how they affect on the model fit.

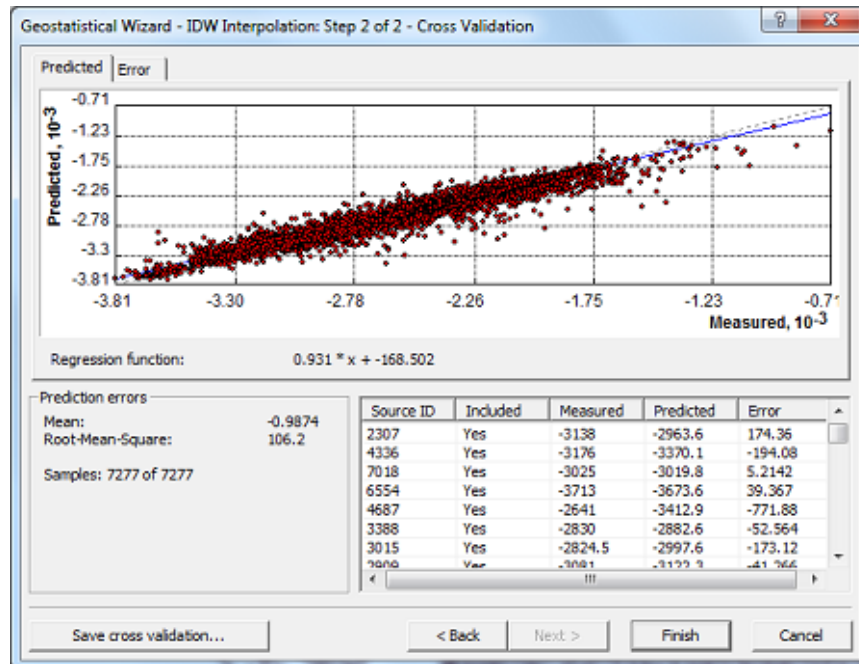

- Our final surface using above described parameters look like that:

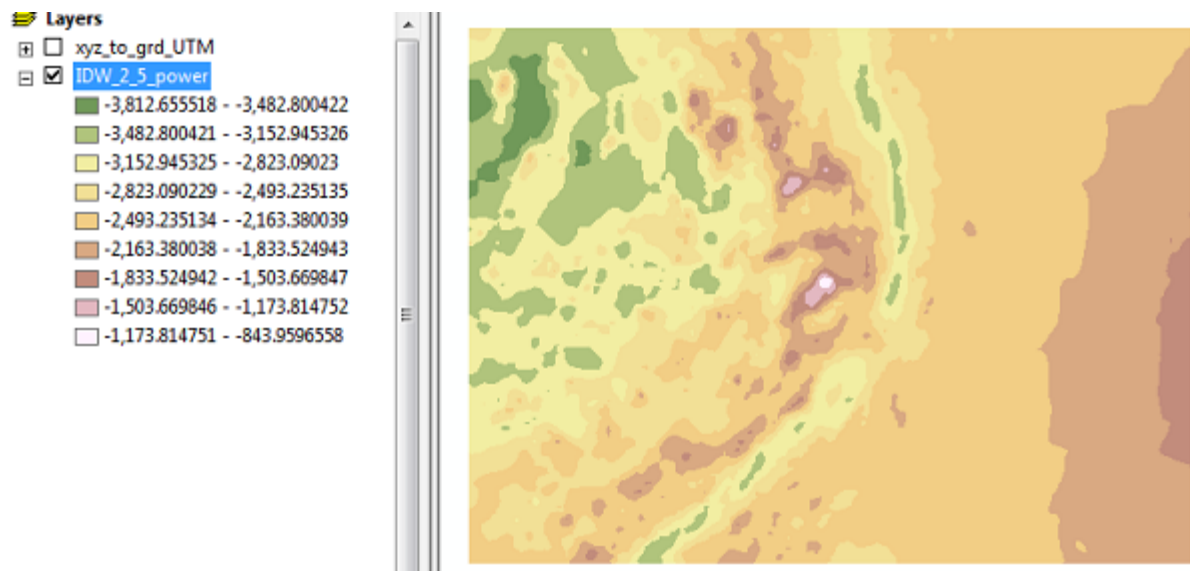

Comparison with original data values

- Here we present how to compare the original data point values with created surface. This could be useful in order to investigate spatial distribution of misfit between model and the measured points. For more information on quality assessment of grids see section 9.2.1.
- You can extract values from the gridded surface corresponding to original data points with Spatial Analyst Tools> Extract Values to Points. Where Input point features are your original .xyz data points and Input raster is your interpolated raster :

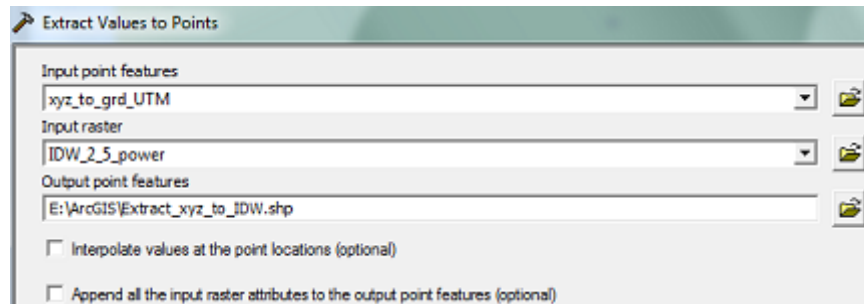

- As a result, a point feature layer is created (we call it Extract_xyz_to_IDW).
- You can view the Attribute table of the layer by right click on the layer> Open attribute table:

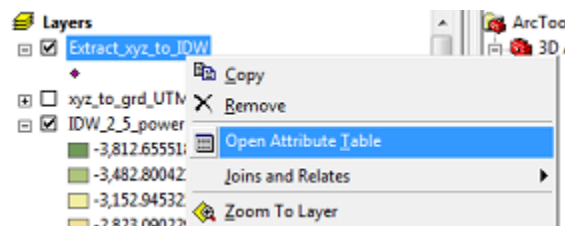

- As you can see from the table it contains information for original data points (x,y,z) and corresponding depth values from our gridded surface (RASTERVALU) for each original data point:

FID	Shape *	X	Y	Z	RASTERVALU
0	Point	8.87392	72.6518	-2353	-2353.928467
1	Point	6.80331	72.7645	-2472.5	-2426.821777
2	Point	9.61194	72.6063	-2248	-2248.000488
3	Point	11.0081	72.5118	-2011.5	-2011.499756
4	Point	8.59257	72.6888	-2387.5	-2388.124756
5	Point	5.31349	72.8319	-2473	-2468.607422
6	Point	11.3085	72.4905	-1953	-1952.330444
7	Point	7.41697	72.7341	-2535	-2533.513672
8	Point	9.0517	72.842	-2328	-2331.982158

- You can calculate differences between these values and visualize them.

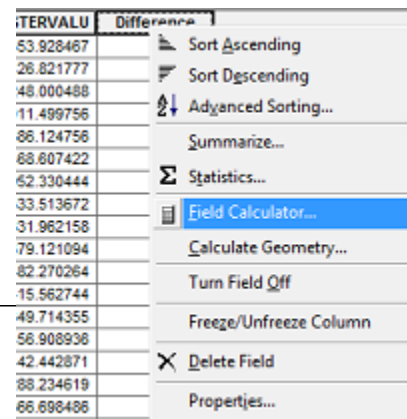

- Go to Options inside the Attribute table and select Add Field option. We will call the new column as “Difference”. After the column is created, right click on the header of new created column and select Field Calculator

- Inside the Field calculator we can define expression for the new column values: a difference between Z and RASTERVALUE columns. After clicking Ok, the values are calculated. Close the attribute table

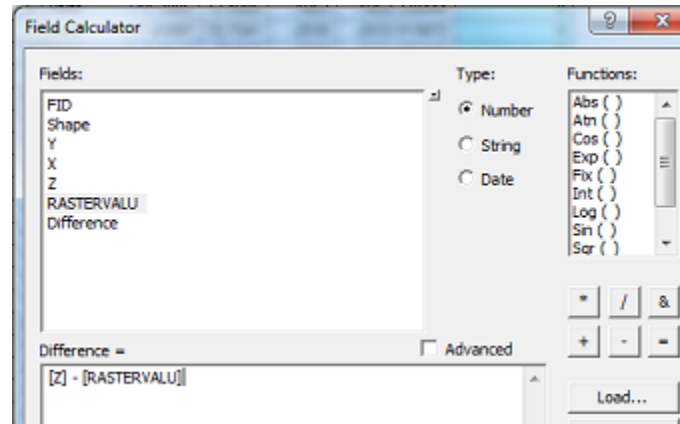

- Now you can visualize the Difference by right clicking on the point layer (Extract_xyz_to_IDW)> Properties. Go to Symbology tab. Select Quantities> Graduated colors. Select the Value Fields as Difference, select the color ramp and number of classes, and click OK.

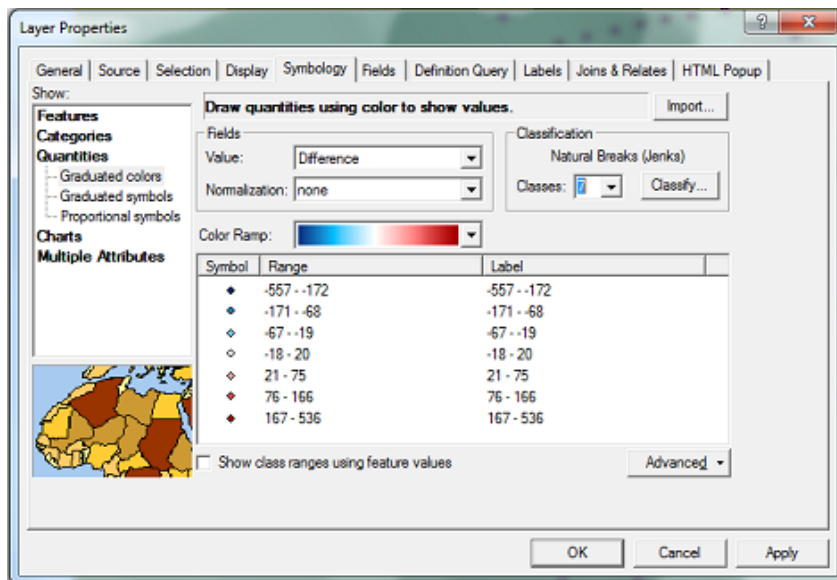

- Now you can see overlaid difference results over the created gridded surface and investigate the regions where differences seem to be significant:

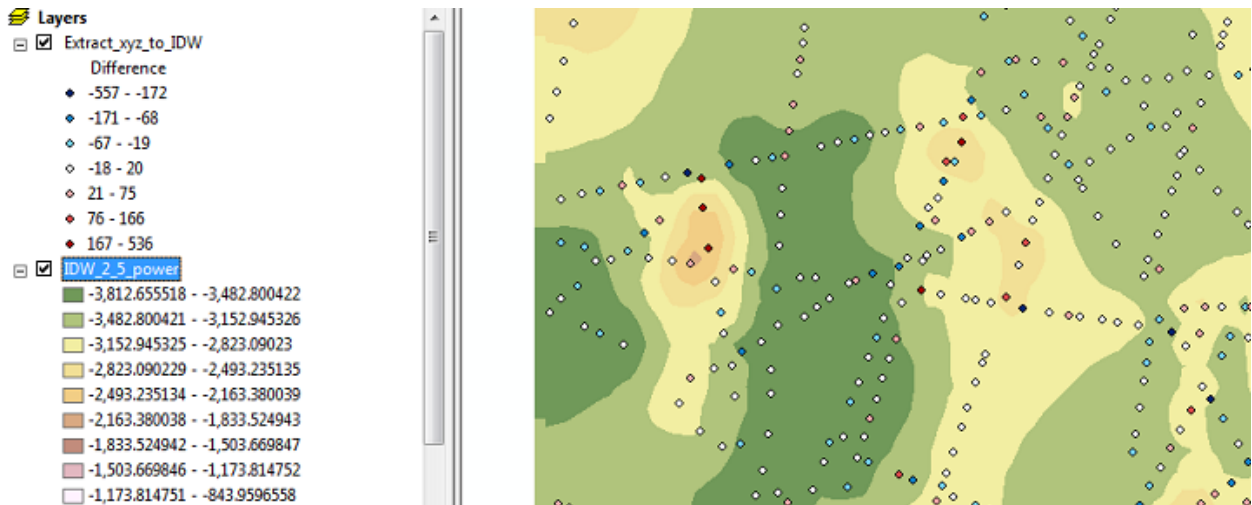

- For more information on analyzing gridded surfaces that you create go to:

http://webhelp.esri.com/arcgisdesktop/9.2/index.cfm?TopicName=About_analyzing_raster_data

http://webhelp.esri.com/arcgisdesktop/9.2/index.cfm?id=603&pid=598&topicname=Surface_creation_and_analysis

See more on interpolation error analyses in other sections 8.3.

8.2.11 Gridding the International Bathymetric Chart of the Arctic Ocean (IBCAO) Version 3.0

¹Martin Jakobsson, ¹Benjamin Hell, ¹Rezwan Mohammad, ²Pauline Weatherall and ³IBCAO Compilation Team

¹ Department of Geological Sciences, Stockholm University, 106 91 Stockholm Sweden

² British Oceanographic Data Centre (BODC), 6 Brownlow Street, Liverpool, UK

³ See Appendix III

Introduction

This Chapter of the IHO-IOC GEBCO Cook Book describes the process used to generate Version 3.0 of the IBCAO grid – a terrain model for the Arctic Ocean region (Jakobsson et al., 2012). The description is aimed to provide the general principles of the gridding and the provided scripts can be adapted and used to generate bathymetric grids for other geographic areas.

Creating a bathymetric grid from source data sets with extreme variations in data density, e.g. sparse ship-track soundings and multibeam grids poses specific problems. Gridding routines are required that can sub-sample high resolution source data while preserving as much detail as

possible in these areas and at the same time, interpolating in areas of sparse data coverage without generating gridding artifacts.

To address these issues, the IBCAO 3.0 grid has been generated in a two-stage process. Firstly a grid is created, using all the available bathymetric data, at a larger grid cell size than required for the final grid. This step helps to address the issue of generating artifacts through interpolation in areas of sparse data coverage. This grid is then sampled to the required grid cell size creating a ‘base grid’. In a final step, the high resolution data sets are added on top of the ‘base grid’, using the remove-restore procedure, which was first developed and used by Forsberg (1993) and Forsberg and Tscherning (1981), and later implemented by Hell and Jakobsson (2011) and Smith and Sandwell (1997), in order to preserve the detail in these areas.

The gridding work is done using routines from the Generic Mapping Tools (GMT) software suite (Wessel and Smith, 1991), <http://gmt.soest.hawaii.edu/>. In the examples given below, the GMT routines are embedded in script files for ease of use. However, if preferred, the individual GMT routines can be run separately.

The generation of the IBCAO 3.0 grid is described in the following sections:

Background to the IBCAO

IBCAO 3.0 Compilation

Workflow overview

Data preparation and merging – workflow step A

Comparing the input data sets – the disambiguation process

Generating ASCII xyz files for use in the gridding process

Gridding – workflow steps B and C

Generating the ‘base grid’ – procedure and gridding script

Remove-restore – workflow step D

Appendix 1: Python script I - Procedure for generating the ‘base grid’ from all available source data

Appendix 2: Python script II - The remove-restore procedure

Background to the IBCAO

The International Bathymetric Chart of the Arctic Ocean (IBCAO) project was initiated in St Petersburg, Russia, in 1997 (Macnab and Grikurov, 1997). The main goal was to create an up-to-date bathymetric portrayal of the Arctic Ocean seafloor north of 64°N. This geographic limit was chosen because the IBCAO aimed to replace the Polar Stereographic Fifth Edition GEBCO Sheet 5.17 (Johnson et al., 1979), extending from 64°N to the North Pole.

At the time that the IBCAO was initiated, Digital Bathymetric Models (DBM) were rapidly becoming the standard bathymetric database used in Geographic Information Systems (GIS) and other mapping analysis software. For this reason, a limit at 64°N was not practical for a DBM compiled on a Polar Stereographic projection with a Cartesian xy-coordinate system, so the IBCAO was extended to cover a rectangular area as shown in Figure 8.3.

The first IBCAO was released into the public domain in 2000 and was referred to as the “Beta version” (Jakobsson et al., 2000). This version was compiled using all the bathymetric data

available at that time including soundings acquired along ship and submarine tracks, spot soundings, and digitized depth contours from published maps. Land topography was included and taken from the USGS GTOPO30 topographic model (U.S. Geological Survey, 1997), except for over Greenland where the topographic grid developed by *Ekholm* (1996) was used.

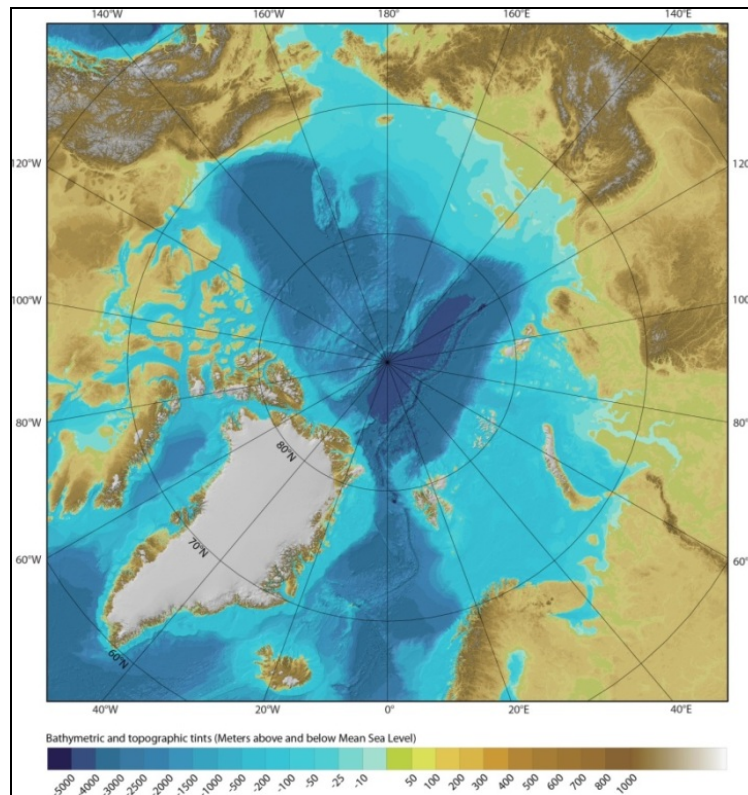

Figure 8.3 The extent of the IBCAO DBM. Projection: Polar Stereographic, true scale at 75° N, WGS 84 horizontal datum. Depths are referenced to Mean Sea Level.

The grid-resolution of the first IBCAO DBM was 2500 x 2500 m on the adopted Polar Stereographic projection. Since this first release, three major updates have been completed; Version 1.0 (Jakobsson and IBCAO Editorial Board Members, 2001), 2.0 (Jakobsson et al., 2008) and 3.0 (Jakobsson et al., 2012).

With specific emphasis on the actual gridding of the bathymetric data, this chapter explains the compilation methods used for generating the IBCAO Version 3.0, from now on referred to as IBCAO 3.0. The DBM grid resolution has been increased to 500 x 500 m and the compilations methods are improved since the Beta version from 2000.

IBCAO 3.0 Compilation

Workflow overview

IBCAO 3.0, is compiled using gridding algorithms and various data processing and filtering tools available in Generic Mapping Tools (GMT), <http://gmt.soest.hawaii.edu/>. GMT version

4.5.8 was used to compile IBCAO 3.0. These GMT routings are embedded in Python scripts (<http://www.python.org/>).

The compilation method is briefly described in the auxiliary material of Jakobsson et al. (2012). The explanation given here complements previously published method descriptions. The aim is to provide a comprehensive guide to the complete grid compilation process. The main gridding workflow of the IBCAO 3.0 is summarized in Figure 8.4. The text below explains each of the steps, A-F, in this workflow.

Compared to the previously released IBCAO 2.0 (Jakobsson et al., 2008), the gridding of Version 3.0 has been enhanced with adding source data with a spatial horizontal resolution equal to, or better than, 500 m and in a final step using the **remove-restore** method (Forsberg, 1993; Forsberg and Tscherning 1981), described in Appendix 2. This generates a grid that preserves the details to the scale of 500 m horizontally in areas with dense source data, i.e. mainly in areas covered by multibeam surveys.

In addition, a source identification grid (SID) is generated allowing users to identify the type of bathymetric source data that contributed to a particular grid cell's depth value. The generation of the source grid is not described in this chapter.

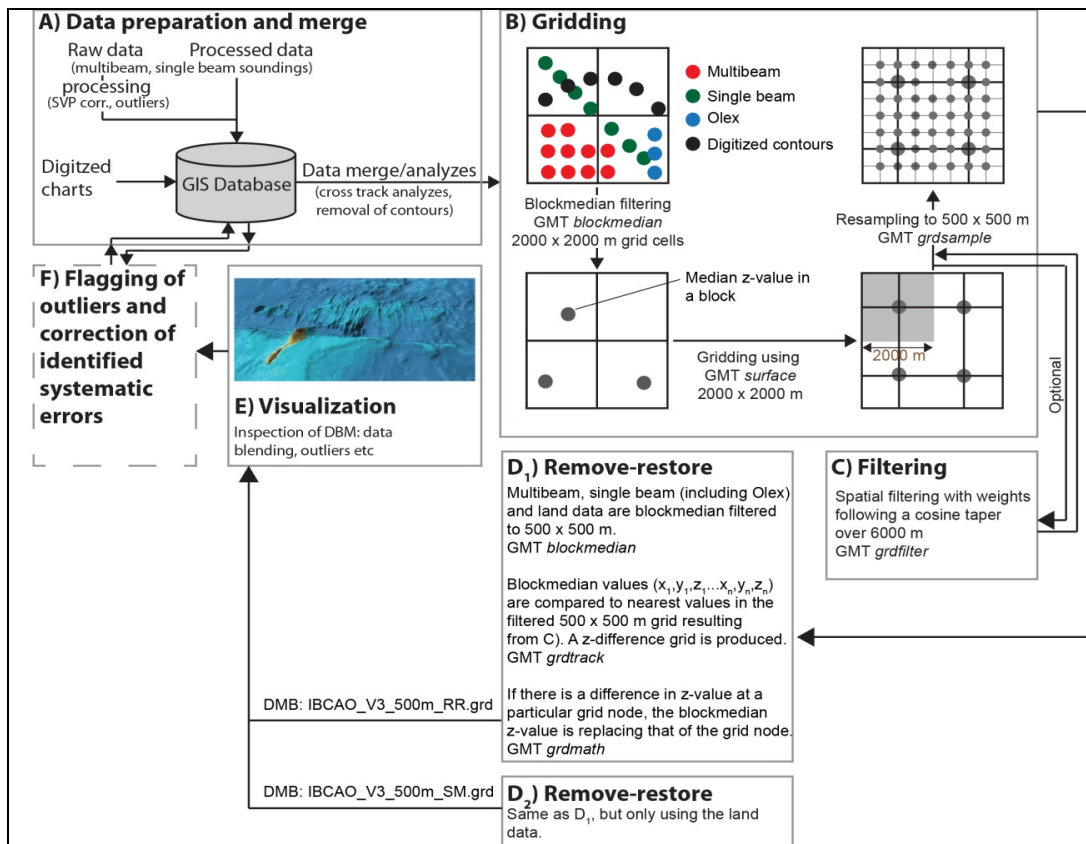

Figure 8.4 Panels A-F describes the most important components in the IBCAO 3.0 compilation process. Figure is modified from Jakobsson et al. (2012).

Data preparation and merging – workflow step A

Preprocessing of all the source bathymetric data to be used in the gridding process is done depending on the data type and origin. This will not be described further here; instead we will focus on the grid generation procedure from the point where the main preprocessing of the data has already been done.

The “clean” bathymetric source data, in the form of high resolution grids, depths soundings along ship tracks, or spot soundings are merged into a GIS database. In addition, digitized depth contours from published maps are imported as line features (polygons) into the database.

In the case of the IBCAO, Intergraph’s *GeoMedia Professional* is used to visualize and analyze all the bathymetric data (Figure 8.5). It should be noted that any GIS capable of visualizing and analyzing very large amounts of point and line features with assigned z-values (depth values) and associated metadata can be used for this process.

Relevant metadata are imported along with the bathymetric data to the GIS database. For a more comprehensive discussion on metadata, the reader is referred to the relevant chapters in this Cook Book.

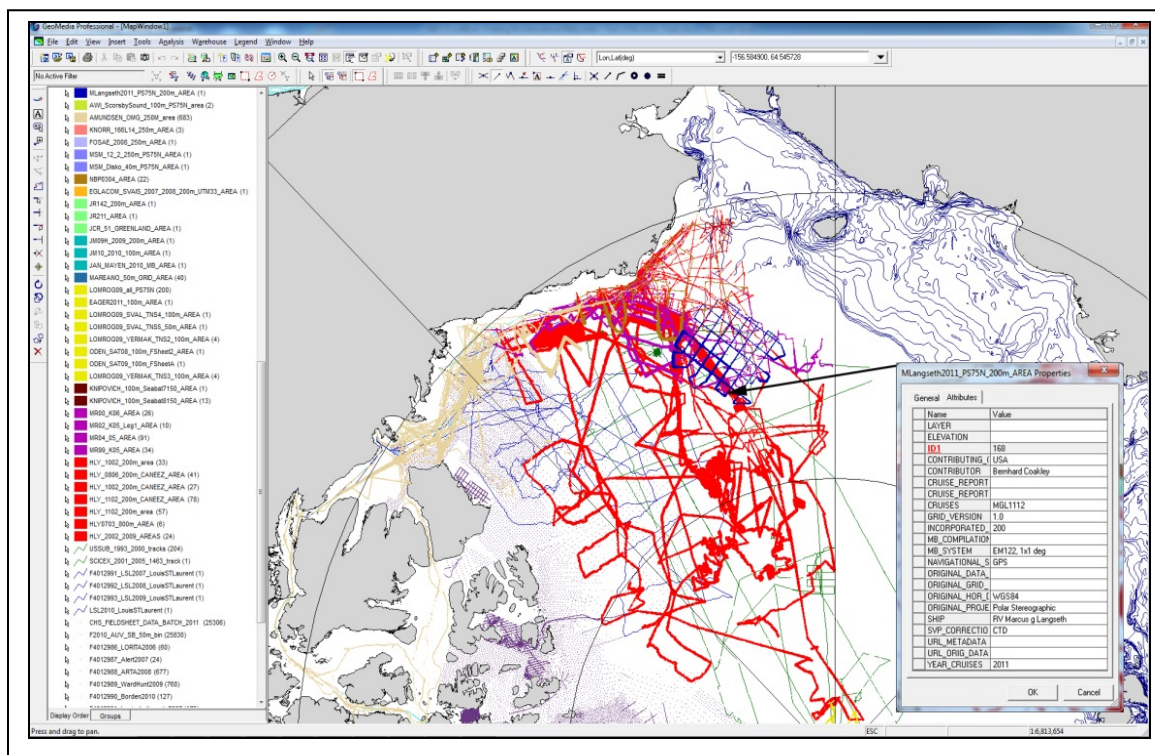

Figure 8.5 Screen view of the GeoMedia Professional GIS workspace with some of the IBCAO source data displayed. The source database resides in several databases that are accessed using GeoMedia Professional. Stored depth data with associated metadata can be displayed and analyzed. In this screen view individual soundings stored as point features are displayed as well as polygons enclosing grids contributed from multibeam surveys. The metadata of the multibeam survey with RV Marcus Langseth 2011 is shown.

The IBCAO compilation has aimed to include as a minimum the metadata listed in Table 8.1, although even this limited set of information has not been available for all bathymetric soundings used in the gridding process. The metadata may be critical for various quality assurance analyses, for example, in the estimation of random errors (Elmore et al., 2012; Jakobsson et al., 2002). The GIS database structure, including how the metadata is linked to soundings, is a comprehensive topic in itself (Hell and Jakobsson, 2008), which will not be described further here.

Although the IBCAO workflow, shown in Figure 8.4, is centered on the use of a GIS database, the actual grid compilation algorithms (B-D) operate on a suite of exported ASCII xyz flat files. This means that a grid compilation project can be setup to use the gridding procedure described here without using a GIS database as a central warehouse for bathymetric data storage.

Minimum metadata requested for contributed bathymetric grids

1. CONTRIBUTOR: (Institution, company, organization etc.)
2. CONTRIBUTING_COUNTRY: (Country codes, ISO_3166)
3. URL_ORIG_DATA: (URL to website describing the grid if available)
4. URL_METADATA: (URL to metadata by the contributor if available)
5. GRID_VERSION: (Version, could be a compilation date)
6. ORIGINAL_GRID_RESOLUTION: (Original horizontal resolution, i.e. grid cell size)
7. INCORPORATED_GRID_RESOLUTION: (Horizontal resolution of the incorporated grid)
8. ORIGINAL_PROJECTION: (Projection of the contributed grid, Mercator, UTM etc.)
9. ORIGINAL_HOR_DATUM: (Horizontal datum of the contributed grid, i.e. WGS 84, NAD1983 etc.)
10. VERTICAL_DATUM: (Vertical datum of the contributed grid, i.e. MSL, MLLW etc.)
11. ORIGINAL_DATA_SOURCES: (Multibeam/Singlebeam/Mixed etc.)

Minimum metadata requested for contributed multibeam grids

As for the contributed bathymetric grids (described above), but with the following additions:

12. MB_SYSTEM: (Brand, model and frequency)
13. SVP_CORRECTION: (CTD, XBT, uncorrected nominal sound speed etc.)
14. SHIP: (Ship name)
15. NAVIGATIONAL_SYSTEM: (RTK GPS, DGPS, GPS etc.)
16. CRUISES: (If the contributed multibeam grid is compiled from more cruises these are listed)
17. YEAR_CRUISES: (Cruise year(s))
18. PI: (Cruise PI(s))

Minimum metadata requested for contributed single beam soundings

As for multibeam grids, except for non-relevant parameters, such as grid cell size etc.

Table 8.1 Minimum metadata requested for bathymetric data contributed for inclusion in the IBCAO

Comparing the input data sets – the disambiguation process

Available GIS tools in *GeoMedia Professional* are used to compare the input data sets in a disambiguation process involving, for example, analyzes of cross-tracks and the match between digitized contours and soundings (Figure 8.6). Systematic errors are identified during this process and corrected if possible. The most commonly found systematic error is due to the sound velocity applied during the conversion from travel time to depth of echo soundings.

IBCAO has adopted the criteria that the DBM grid should contain so-called “corrected depths”, i.e. each depth should be derived from travel time using a proper harmonic mean of the water column’s sound velocity. However, several contributed bathymetric surveys were carried out using a flat nominal sound velocity of 1500 m/s, and if that not is stated in the metadata, the depths values will systematically be different from corrected depths. This inconsistency is commonly found from cross track analyzes. When such a systematic difference has been identified, a correction has been carried out using the capability of performing calculations in the GIS environment. For example, during the compilation of IBCAO 2.0 systematic differences between the included soundings from US nuclear submarine cruises were identified and adjusted (Jakobsson et al., 2008).

The digitized depth contours from bathymetric maps were used in the compilation of the first IBCAO Beta version. Since then, one of the main goals has been to remove these contours from the grid compilation and instead grid directly from the sounding database where data density permits (Figure 8.6). However, IBCAO still relies on gridding using digitized depth contours from published maps in areas of the Arctic where original soundings either are too sparse to grid or not have been made available to the IBCAO Compilation Team.

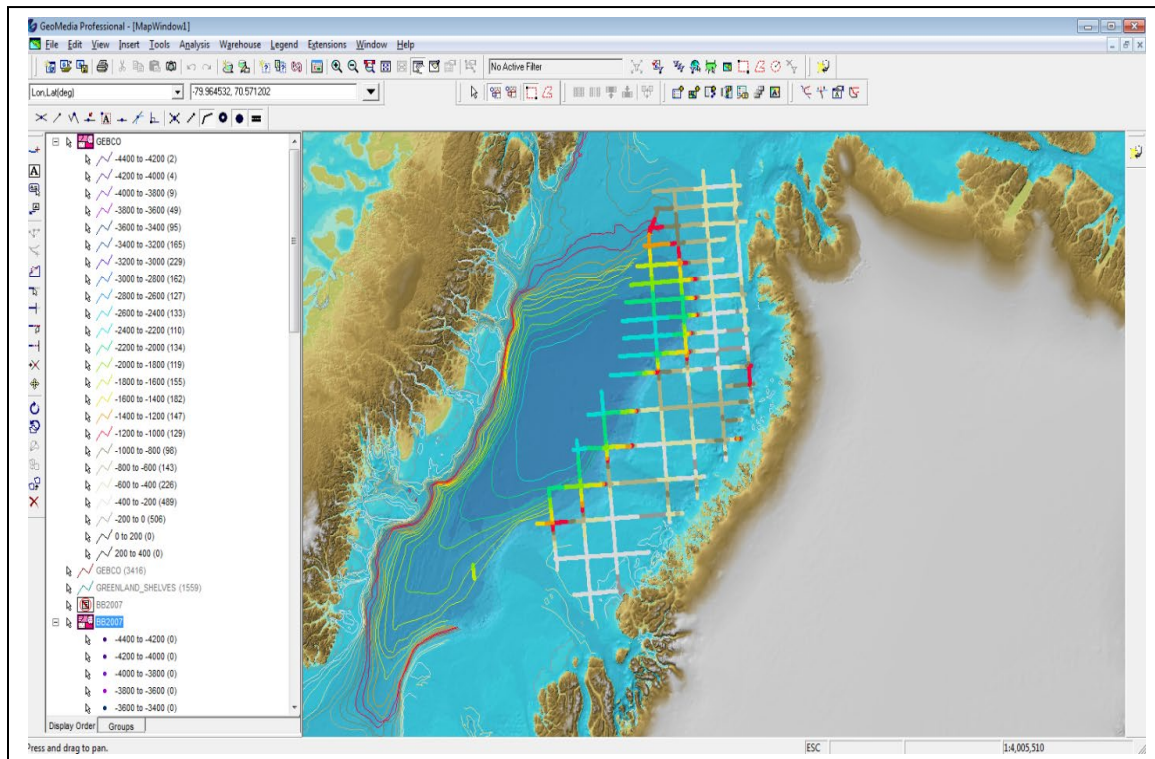

Figure 8.6 Screen view of the GeoMedia Professional GIS workspace with depth contours from GEBCO shown together with echo soundings from a seismic reflection survey contributed to IBCAO through the Geological Survey of Denmark and Greenland (GEUS). The color coding represents depths. Note how the contours are cropped at the edge of the echo sounding data. If there are noticeable mismatches between soundings and contours, edgematching may have to be carried out by moving the contours to fit the soundings. The general goal for IBCAO has been to remove contours from the compilation and instead grid directly from sounding data.

The GIS capability has also been used to carry out spatial queries to find single beam and spot soundings that reside within the boundaries of areas mapped with multibeam. When this is the case, the single beam and spot soundings are flagged and removed from the gridding process.

Generating ASCII xyz files for use in the gridding process

After the time consuming disambiguation process, all data that pass the set criteria for use in the gridding process are exported from the GIS database as xyz points. In the case of depth contours, the xyz values of their nodes are exported.

The horizontal datum of the IBCAO is WGS84 and the projection is Polar Stereographic with a true scale at 75°N. Therefore, the xy-coordinates for each exported depth (z-value) are based on this projection and datum.

Each multibeam or single beam survey, digitized contours from a bathymetric map, or collection of spot soundings is exported to separate ASCII files. This permits the generation of the SID grid and the option to use different kinds of data in the different gridding steps shown in Figure 8.4 B-D.

Gridding – Workflow steps B and C

The IBCAO gridding is done using GMT routines that are embedded in two Python scripts. Other scripting languages such as Perl or AWK can be used or you can run the GMT commands individually without embedding them in a script.

However, there are numerous advantages to using a scripting language. For example, it is possible to work with variables and the script programming language allows the user to construct their own data processing routines.

We use two Python scripts:

- One for the main gridding procedure to develop the ‘base grid’
- One for the remove-restore procedure to add the higher-resolution data sets on top of the ‘base grid’.

IBCAO was gridded on a computer with Windows 7 (64-bit). The Python scripts are executed in a DOS-prompt, and the GMT specific commands are executed in Python using:

```
os.system('gmtcommand')
```

Both GMT and Python are available for other operating systems, and the procedure described here is not limited to Windows.

A simplified version of the IBCAO Python gridding script is supplied in Appendix 1. The simplification consists of removing several internal data checking procedures in order to make the gridding recipe easier to follow.

Generating the ‘base grid’ – the gridding script

Explanations of the components of this script are given below and are numbered to match the corresponding sections in the script outlined in Appendix 1.

1) Setup the input variables

There are numerous variables that are defined here to be used in the Python script. The concept has been that instead of changing, for example the grid cell size, boundary box or data path in all the individual GMT routines that will use these parameters, variables are set so it is necessary to change their values only in one place. The different variables are described in Appendix 1.

2) Creation of a list of input files for use in the gridding process

A list of all the individual ASCII xyz-files that will be used in the gridding process is assembled as in the example Python script below:

```
FILElist=['file1_SB.xyz', 'file2_MB.xyz', 'file3_CONT.xyz', 'file4_TOPO.xyz']
```

In this example, four xyz files are listed for use in the gridding process. Further files can be added to this list.

At this stage, we do not separate the data files depending on their data type, e.g. multibeam, spot soundings, contour or grid etc. there is no separation of the different data categories as the first grid created will constitute a “base grid” developed from all the available data.

A separation is made later in the process where remove-restore is used to add all the higher resolution single beam, multibeam and topography data on top of the “base grid”.

3) Check data consistency and merge files

When large amounts of data are exported from a database, there may occasionally be some problems with data inconsistency such as, for example, an empty line, a missing coordinate, or missing depth value. Therefore a simple loop is included that goes through every line in the input files and check if three xyz values are included. This loop can be extended with additional criteria, such as maximum allowable depth or height etc.

The output from this loop is one large file of data merged from the individual input files. The name of this merged file is set by variable **DATAstr**, defined in the ‘set variables’ section of the Python script file.

4) Segment the data into regions to handle large data amounts with GMT "blockmedian"

This tiling of the data set may only be necessary when working with large volumes of data. For too large datasets, the GMT program **blockmedian** may not be able to allocate enough memory.

It was noted that when the data set is comprised of more than approximately 100 million soundings, and the spatial area to be gridded is as large as the IBCAO, then the available RAM became an issue. The exact limitation has not been investigated. To further boost the available memory the following two DOS commands have been added to the script:

```
set EMM=RAM  
  
set dos=high, umb
```

Within the Python script, the GMT routine **gmtselect** is used to cut the data into four tiles.

The following example shows the use of **gmtselect** to extract a subset from the IBCAO source data set – generating file R1.xyz

Routine as shown in python script I:

```
os.system('gmtselect -R%s -V %s\\%s > %s\\%s' % (BM_R1,DIRstr, DATAstr, DIRstr, R1))
```

Version using parameters from the ‘setup variables’ section of python script I:

```
gmtselect -R0/2910000/0/2910000 -V C:\\IBCAOData\\IBCAOinput.xyz > C:\\IBCAOData\\R1.xyz
```

5) Block median filtering

Block median filtering is shown as the first step in the gridding process in Figure 8.4B. This is required as a data preprocessing step before the subsequent surface spline in tension gridding is carried out using the GMT routine **surface** (Smith and Wessel, 1990).

Block median filtering provides a way of decimating the input data so that a maximum of one z-value remains for each grid cell. This step is done as it is not possible to fit a surface exactly through more than one point at each grid node; the surface is then simply over determined.

There are several ways to decimate your data, in the case of developing a bathymetric grid, one of the reasons for using the median value within every non-empty cell is that this will decrease the influence of potential outliers compared to if the mean is used.

There are a number of options available with the GMT routine **blockmedian**. For developing the, IBCAO 3.0 the option **-Q** is used. This finds the median z-value within the defined grid cell size and uses its xy coordinates. Blockmedian’s default is that the median x and median y is found independently of median z.

In the case of the IBCAO 3.0, the grid cell size in the block median filtering processing was set, with the option **-I**, to 2000 m. This should be the same as the cell size that will be used when gridding the data with the GMT **surface** command.

The following example shows the use of **blockmedian** to median filter the subset of the IBCAO source data set.

Routine as shown in python script I:

```
os.system('blockmedian -R%s -I%s -V -Q %s\\%s > %s\\%s' % (BM_R1,BM_I, DIRstr, R1, DIRstr, BM_OUTPUT1))
```

Version using parameters from the ‘setup variables’ section of python script I

```
blockmedian -R0/2910000/0/2910000 -I2000 -V -Q C:\\IBCAOData\\R1.xyz > C:\\IBCAOData\\OUTFILE_BM1.xyz
```

6) Merge the GMT Blockmedian filtered segments into one file

This step consists of Python loops that open each of the four files of block median values and merges them all into one file that will be used as input to the gridding process using GMT’s **surface**.

7) Gridding, crop, filter and re-sampling

This section covers the gridding, filtering and re-sampling of the ‘base grid’, generated from all the available source data. The first step consists of gridding all the data that have been filtered with blockmedian with the GMT routine **surface**. The following key parameters are set for **surface**:

-
- R** This sets the geographic limits of the grid and should be same as the combined subset regions created in step 4. Note that a slightly larger area is gridded than is required for the final grid. It may be enough to extend the gridded region with a few grid cells in all directions. Edge effects often occur during the gridding, and by applying a larger area here the outer edges may be cropped subsequently.
 - I** Grid cell size in the same units as the data, in the case of the IBCAO this is meters. The cell size should be the same as used in the **blockmedian** filtering process. IBCAO 3.0 used 2000 m.
 - N** Maximum number of iterations in each gridding cycle. The default is 250. Complex data may require more than 250 iterations in order to allow the surface to fully converge to the data points. For IBCAO 3.0 compilation `-N5000` was used.
 - T** Tension of the minimum curvature surface. A value of 0 applies no tension and gives a minimum curvature smooth solution while a value of 1 applies maximum tension, which gives a harmonic spline solution where local max/min z-values only occur at real data points. Trial and error has resulted in the IBCAO grids being compiled using values between 0.32 and 0.4.
 - Lu** The parameter has recently been added to the GMT surface routine. It allows the user to constrain the range of the output grid, in this case, setting an upper limit of the z range of the grid. *For the IBCAO V3.0, this was set to -0.1.* IBCAO is gridded with both topography and bathymetry data in order to get a good representation of the coastline. However, the grid created in this first step is limited to only contain values below the coastline. The topography is later merged onto this grid using the remove-restore concept.

An example of the use of the GMT **surface** routine for gridding the blockmedian filtered data:

Routine as shown in python script I:

```
os.system('surface %s\\%s -R%s -I%s -N%s -T%s -G%s\\%s -Lu%s -V' % (DIRstr, BM_OUTPUT, BM_R, S_I, N_I, S_T, DIRstr, S_grd_out, LU))
```

Version using parameters from the 'setup variables' section of python script I:

```
surface C:\\IBCAOData\\OUTFILE_BM.xyz -R-2910000/2910000/-2910000/2910000 -I2000 -N5000 -T0.32 -G C:\\IBCAOData\\out_grd.grd -Lu-0.1 -V
```

The grid generated with the GMT **surface** command above is cropped to its final extent using **grdcut** and filtered using **grdfilter**. The latter is optional, and has been implement specifically as all the high resolution data will again be merged onto this "base grid" using remove-restore.

An example of using GMT's **grdcut** to crop the grid generated using **surface**:

Routine as shown in python script I:

```
grdcut %s\\%s -R%s -G%s\\%s' % (DIRstr, S_grd_out, CUT_R, DIRstr, CUT_grd_out
```

Version using parameters from the 'setup variables' section of python script I:

```
grdcut C:\\IBCAOData\\out_grd.grd -R-2904000/2904000/-2904000/2904000 -G C:\\IBCAOData\\out_grd01.grd
```

There are several types of spatial filters to choose between. For IBCAO 3.0 a cosine arch was selected with `-Fc6000`. This means that a weighted averaging with cosine arc weights are applied over 6000 m. The parameter `-D0` means that the set filter width is in the same unit as the grid.

An example of using GMT's **grdfilter** to filter the cropped grid:

Routine as shown in python script I:

```
'grdfilter %s\\%s -G%s\\%s -R%s -D0 -Fc%s' % (DIRstr, CUT_grd_out, DIRstr, FILT_grd_out, CUT_R, FILT))
```

Version using parameters from the 'setup variables' section of python script I:

```
grdfilter C:\\IBCAOData\\out_grd01.grd -G C:\\IBCAOData\\filt_grd01.grd -R-2904000/2904000/-2904000/2904000 -D0 -F6000
```

The final step of the gridding procedure, shown in Figure 8.4B, consists of resampling the grid to a higher resolution using GMT's **grdsample**. This resolution should match the desired resolution of your final grid. In the case of IBCAO 3.0 the grid is resampled to 500x500 m.

An example of using GMT's **grdsample** to sample the cropped/filtered grid to the desired resolution of your final grid:

Routine as shown in python script I:

```
os.system('grdsample %s\\%s -G%s\\%s -R%s -I%s -V' % (DIRstr, FILT_grd_out, DIRstr, RESAMP_grd_out, CUT_R, R_))
```

Version using parameters from the 'setup variables' section of python script I:

```
grdsample C:\\IBCAOData\\filt_grd01.grd -GC:\\IBCAOData\\resamp_grd01.grd -R-2904000/2904000/-2904000/2904000 -I500 -V
```

This re-sampled grid is now the '**base grid**' to be used as a base for in the remove-restore process described below.

Remove-restore – Workflow step D

The gridding steps and algorithms used to develop the IBCAO 2.0 are nearly identical to those described above. However, for the generation of the IBCAO 3.0, a final of step of adding the multibeam, dense single beam echo soundings and land topography on top of the 'base grid' using the **remove-restore** method was included (Forsberg, 1993; Forsberg and Tscherning, 1981).

This final step, generates a grid that preserves the detail to the scale of 500 m horizontally in areas with dense source data, i.e. mainly in areas covered by multibeam surveys. The value of the predicted bathymetry is added back to the interpolated difference.

The **remove-restore** procedure uses a set of GMT routines. The first step is to calculate the difference between two gridded data sets. These difference values are then gridded and added on top of the base grid. This preserves the resolution of the input data.

For the IBCAO V3.0 grid generation work, dense single beam echo soundings refers to a spatial coverage where the soundings are closer to or less than 500 m apart. This is because the target resolution of the final grid is 500 x 500 m. Sparse random tracklines are omitted from the remove-restore process.

The grid used in this step is the 500 x 500 m ‘base grid’ created from re-sampling of the filtered 2000 x 2000 m grid, Box C in Figure 8.4.

The following gives a description of the components of the **remove-restore** python script in Appendix 2. The description is organized so that each numbered explanation is marked with a corresponding number in the script. The numbering starts from 8 in order to avoid confusion with the description of the script in Appendix 1.

8) Setup the input variables

As described in section 1 above, the variables to be used in the GMT routines and Python script are setup. These variables are defined in the script in Appendix 2.

9) Merge all the input data

The separate files of multibeam and dense single beam echo soundings and land topography data are merged into one file. In the case of the IBCAO 3.0, this also includes the Olex echo sounding data collected primarily by fishing vessels (see Jakobsson et al., 2012).

The merge is done by reading all the input files and checking that there are three variable provided (this procedure is described in section 2 above). One merged output file is written containing all the data that will be added onto the input ‘base grid’ grid using remove-restore.

10) Cut the data set into sub-regions

This step may only be necessary when working with large volumes of data which may cause memory issues when using the GMT routine **blockmedian**. See explanation 4 above.

In this example, the outputs from this segmentation process are the files R1_RR.xyz..... R4_RR.xyz. Note that the number and geographic division of the regions can be modified to fit the data volume and spatial distribution.

11) Block median filtering

Block median filtering provides a way of decimating the input data so that a maximum of one z-value remains for each grid cell. This step is done as it is not possible to fit a surface exactly through more than one point at each grid node; the surface is then simply over determined. See explanation 5 above.

Routine as shown in python script II:

```
os.system("blockmedian -R%s -I%s -V -Q %s\\%s > %s\\%s' % (BM_R1,BM_I, DIRstr, R1, DIRstr, BM_RR_OUTPUT1))
```

Version using parameters from the ‘setup variables’ section of python script II:

```
blockmedian -R'0/2910000/0/2910000' -I500 -V -Q m:\my_data\R1_RR.xyz > C:\IBCAOData\OUTFILE_RR_BM_1.xyz
```

12) Merge the blockmedian filtered segments

One output file is created from this process. The name of the file is set by variable IBCAO_RR_SEGMENT. For further details, see explanation 6 above.

13) Find the depth in the ‘base grid’ at the location of the blockmedian filtered data points

This next step finds the depth in the ‘base grid’ at the location of the blockmedian filtered data points. This is done so we can compare the difference in z-values between the high resolution data that were blockmedian filtered and the resampled 500 x 500 m base grid.

The following line in the script will take the merged blockmedian filtered data, the resampled 500 x 500 m grid and interpolate from the grid at the points in the input file.

Routine as shown in python script II:

```
os.system('grdtrack %s -G%s -V -S > %s' % (IBCAO_RR_SEGMENT, IBCAO_resamp, IBCAO_resamp_predict))
```

Version using parameters from the ‘setup variables’ section of python script II:

```
grdtrack IBCAO_RR_SEGMENT.xyz -Gresamp_grd01.grd -V -S > resamp_grd01_pred.xyzz
```

The resulting output ASCII file, “resamp_grd01_pred.xyzz” , looks like:

x_1	y_1	z_{1bm}	z_{1i}
..
x_n	y_n	z_{nbm}	z_{ni}

where x_1, y_1 , are the coordinates for a blockmedian depth z_{1bm} created in step 11) and z_{1i} the depth retrieved from the 500 x 500 m grid at this location.

14) Compute the difference in z-values between the blockmedian filtered data and the base grid That is the difference between z_{1bm} and z_{1i} in the example above. If the depth difference here is bigger than a threshold set in the script detailed in Appendix 2 (variable DIFF_P) it is written to a file: IBCAO_diff.xyz

15) Create a difference grid

A grid is created, using the GMT nearneighbor routine, that consist of the differences between the blockmedian filtered data and the resampled 500 x 500 m base grid. The neighbor routines reads x,y,z from an input file and uses a nearest neighbor algorithm to assign an average value to each node that have one or more points within a radius centered on the node.

An example is given below of gridding with nearneighbor:

Routine as shown in python script II:

```
os.system('nearneighbor %s -G%s -R%s -I%s -S1000 -N4 -E0 -V' % (IBCAO_resamp_diff, IBCAO_resamp_diff_GRD, BM_R, BM_I))
```

Version using parameters from the ‘setup variables’ section of python script II:

```
neareighbor IBCAO_diff.xyz -GIBCAO_diff.grd -R-2904000/2904000/-2904000/2904000 -I500 -S1000 -N4 -E0 -V
```

16) Merge the difference grid on top of the base grid

The difference grid, from step 15, above is ‘added’ to the base grid using the GMT routine **grdmath** to create the final grid. In the example given below, the final grid file is called `IBCAO_final_RR.grd`.

Routine as shown in python script II:

```
os.system('grdmath %s %s ADD = %s' % (IBCAO_resamp,IBCAO_resamp_diff_GRD,IBCAO_final))
```

Version using parameters from the ‘setup variables’ section of python script II:

```
grdmath resamp_grd01.grd IBCAO_diff.grd ADD = IBCAO_final_RR.grd
```

References

- Ekholm, S., 1996, A full coverage, high-resolution, topographic model of Greenland computed from a variety of digital elevation data: *Journal of Geophysical Research*, v. 101, no. B10, p. 21961-21972
- Elmore, P. A., Fabre, D. H., Sawyer, R. T., and Ladner, R. W., 2012, Uncertainty estimation for databased bathymetry using a Bayesian network approach: *Geochem. Geophys. Geosyst.*, v. 13, p. Q09011.
- Forsberg, R. 1993, Modelling the fine-structure of the geoid: methods, data requirements and some results: *Surveys of Geophysics*, v. 14, no. 4, p. 403-418.
- Forsberg, R., and Tscherning, C., 1981, The use of height data in gravity field approximation by collocation: *Journal of Geophysical Research*, v. 86, no. B9, 7843-7854.
- Hell, B., and Jakobsson, M., 2008, Data Model and Processing Environment for Compiling Heterogeneous Bathymetric Data: *International Hydrographic Review*, v. 9, no. 1, p. 23-33.
- Hell, B., and Jakobsson, M., 2011, Gridding heterogeneous bathymetric data sets with stacked continuous curvature splines in tension: *Marine Geophysical Research*, v. 32, no. 4, p. 493-501.
- Jakobsson, M., Calder, B., and Mayer, L., 2002, On the effect of random errors in gridded bathymetric compilations: *Journal of geophysical research*, v. 107, no. B12, 2358, p. 1 - 11.
- Jakobsson, M., Cherkis, N., Woodward, J., Macnab, R., and Coakley, B., 2000, New grid of Arctic bathymetry aids scientists and mapmakers: *EOS, Transactions American Geophysical Union*, v. 81, p. 89, 93, 96.
- Jakobsson, M., and IBCAO Editorial Board Members, 2001, Improvement to the International Bathymetric Chart of the Arctic Ocean (IBCAO): Updating the Data Base and the Grid Model, *in* Union, A. G., ed., *American Geophysical Union Fall Meeting, Volume 82: San Francisco, CA, USA, EOS Transactions*, p. OS11B-0371.

-
- Jakobsson, M., Macnab, R., Mayer, L., Anderson, R., Edwards, M., Hatzky, J., Schenke, H. W., and Johnson, P., 2008, An improved bathymetric portrayal of the Arctic Ocean: Implications for ocean modeling and geological, geophysical and oceanographic analyses: *Geophysical Research Letters*, v. 35, p. L07602.
- Jakobsson, M., Mayer, L., Coakley, B., Dowdeswell, J. A., Forbes, S., Fridman, B., Hodnesdal, H., Noormets, R., Pedersen, R., Rebesco, M., Schenke, H. W., Zarayskaya, Y., Accettella, D., Armstrong, A., Anderson, R. M., Bienhoff, P., Camerlenghi, A., Church, I., Edwards, M., Gardner, J. V., Hall, J. K., Hell, B., Hestvik, O., Kristoffersen, Y., Marcussen, C., Mohammad, R., Mosher, D., Nghiem, S. V., Pedrosa, M. T., Travaglini, P. G., and Weatherall, P., 2012, The International Bathymetric Chart of the Arctic Ocean (IBCAO) Version 3.0: *Geophys. Res. Lett.*, v. 39, no. 12, p. L12609.
- Macnab, R., and Grikurov, G., 1997, Report: Arctic Bathymetry Workshop: Institute for Geology and Mineral Resources of the Ocean (VNIIOkeangeologia).
- Smith, W. H. F., and Sandwell, D. T., 1997, Global seafloor topography from satellite altimetry and ship depth soundings: *Science*, v. 277, p. 1957-1962.
- Smith, W. H. F., and Wessel, P., 1990, Gridding with continuous curvature splines in tension: *Geophysics*, v. 55, p. 293-305.
- U.S. Geological Survey, 1997, GTOPO30 Digital Elevation Model: US Geological Survey, 0.5-minute Global Topography grid.
- Wessel, P., and Smith, W. H. F., 1991, Free software helps map and display data: *EOS Transactions, American Geophysical Union*, v. 72, no. 41, p. 441, 445-446.

Appendix 1: Python script I

Procedure for generating the 'base grid' from all available source data

```
# -*- coding: cp1252 -*-
#####
# GEBCO Cook Book Appendix 1 "Stage 1: generating a base grid for the International Bathymetric Chart of the Arctic
# Ocean (IBCAO) Version 3.0"
#
# This script contains the procedure used in stage 1 of the IBCAO 3.0 grid generation process. It covers the generation
# of a base grid based on all the available bathymetric source data. Stage 2 of the process involves adding high density data
# on top of the base grid using the 'remove-restore' procedure. This is covered in a separate script.
#
# This script is setup with example values included. The example values were used to grid IBCAO 3.0.
# The script will perform the following:
# 1. Setup of variables
# 2. Creation of file list for input to gridding
# 3. Check data consistency and merge files
# 4. Segment the data set into regions to handle large data amounts with GMT "blockmedian"
# 5. Block median filtering
# 6. Merge block median filtered segments into one file
# 7. Gridding, crop, filter, and resampling
#     7.1. Gridding using surface.
#     7.2. Crop and filter the grid
#     7.3 Resampling of the grid.
#
# Written by Martin Jakobsson
# Department of Geological Sciences
# Stockholm University
#
# September 23, 2012
#
#
#
#####
#####

from __future__ import division #This line includes the true division avoiding problems with unwanted floor division
import fileinput
import os

#####
# 1: Setup of variables
#####
Cint=0 #Counter for loop in section 3
DIRstr='C:\\IBCAOData\\' #Path to data files
DATAstr='IBCAOinput.xyz' #Main file holding the source data for gridding. It consists of a merge of all input files.

# GMT input variables
BM_I='2000' # Blockmedian filter bin size, this should be the same as will be used for the gridding work,
BM_R='-2910000/2910000/-2910000/2910000' #Blockmedian region set for GMT. This is the regional set in
Polarstereographic coordinates for the IBCAO gridding.
#The user must change this to the appropriate region for the task. It could be set in any coordinate system or lat lon if a
geographic grid is created. Note that this region should extend slightly outside of the final grid boundaries to account for
edge effects.

BM_R1='0/2910000/0/2910000' #Region 1 for subset tiling. This tiling is only required for very large data sets (100
million soundings or more).
BM_R2='0/2910000/-2910000/0' #Region 2 for subset tiling
```

```

BM_R3='-2910000/0/-2910000/0' #Region 3 for subset tiling
BM_R4='-2910000/0/0/2910000' #Region 4 for subset tiling

#Output files from the subset tiling
R1='R1.xyz'
R2='R2.xyz'
R3='R3.xyz'
R4='R4.xyz'

#Output files from the Blockmedian filtering of the different regions
BM_OUTPUT1='OUTFILE_BM1.xyz'
BM_OUTPUT2='OUTFILE_BM2.xyz'
BM_OUTPUT3='OUTFILE_BM3.xyz'
BM_OUTPUT4='OUTFILE_BM4.xyz'
BM_OUTPUT='OUTFILE_BM.xyz' #Output file of the entire region

S_I='2000' #Gridding cell size. Value is set as used for IBCAO 3.0
R_I='500' #Resampling grid size
FILT='6000' #Filter size for smoothing
S_T='0.32' #Tension parameter, for use with GMT's surface
N_I='5000' #Max iterations in each gridding cycle. Default is set to 250
LU='5000' #Value constraining the upper limit of the grid
S_grd_out='out_grd.grd' #Grid output file, unfiltered
CUT_R='-2904000/2904000/-2904000/2904000' #Geographic region of the final grid
CUT_grd_out='out_grd01.grd' #Cropped grid
FILT_grd_out='filt_grd01.grd' #Filtered grid
RESAMP_grd_out='resamp_grd01.grd' #Resampled grid at the spacing set by R_I

#####
# Point 2: Creation of filelist for input to the gridding procedure
# Note that there is not a separation of the data here into different categories, this is done in the remove-restore
# procedure
#####
#Input files are listed below, for additional files increase the list
FILElist=['file1_SB.xyz', 'file2_MB.xyz', 'file3_CONT.xyz', 'file4_TOPO.xyz']
print FILElist[1]

#####
# Point 7: Gridding , crop, filter and resampling
#####
def grid():

    #####
    # 7.1. Grid the data using GMT surface
    os.system('surface %s\\%s -R%s -I%s -N%s -T%s -G%s\\%s -Lu%s -V' % (DIRstr, BM_OUTPUT, BM_R,
S_I, N_I, S_T, DIRstr, S_grd_out, LU))

    #####
    # 7.2. Crop and filter the grid
    os.system('grdcut %s\\%s -R%s -G%s\\%s' % (DIRstr, S_grd_out, CUT_R, DIRstr, CUT_grd_out))
    os.system('grdfilter %s\\%s -G%s\\%s -R%s -D0 -Fc%s' % (DIRstr, CUT_grd_out, DIRstr, FILT_grd_out,
CUT_R, FILT))

    #####
    # 7.3 Resampling of the IBCAO grid
    os.system('grdsample %s\\%s -G%s\\%s -R%s -I%s -V' % (DIRstr, FILT_grd_out, DIRstr, RESAMP_grd_out,
CUT_R, R_I))

    #####

```

```

exit()

#####
# Point 3: Check the data for consistency (no empty lines or large outliers) and file merge
#####

F=open(r'%s\\%s' % (DIRstr,DATAstr), 'w+' )

print 'input file directory %s\n' % (DIRstr)
print '1. The following files will scanned and checked for consistency\n'
print '%s' % (FILElist)

while Cint <= len(FILElist)-1:
    G=open('%s%s' % (DIRstr,FILElist[Cint]), 'r' )
    while 1:
        line=G.readline()
        line_items=line.split()
        if not line: break
        if len(line_items) == 3:
            F.write(line)
    Cint +=1
    G.close()

F.close()

#####
# Point 4: Segment the data set into regions to handle large data amounts with GMT "blockmedian"
#####

os.system('set EMM=RAM')
os.system('set dos=high, umb')
os.system('gmtselect -R%s -V %s\\%s > %s\\%s' % (BM_R1,DIRstr, DATAstr, DIRstr, R1))
os.system('gmtselect -R%s -V %s\\%s > %s\\%s' % (BM_R2,DIRstr, DATAstr, DIRstr, R2))
os.system('gmtselect -R%s -V %s\\%s > %s\\%s' % (BM_R3,DIRstr, DATAstr, DIRstr, R3))
os.system('gmtselect -R%s -V %s\\%s > %s\\%s' % (BM_R4,DIRstr, DATAstr, DIRstr, R4))

# #####
# Point 5: Block median filtering
# #####

os.system('set EMM=RAM')
os.system('set dos=high, umb')
os.system('blockmedian -R%s -I%s -V -Q %s\\%s > %s\\%s' % (BM_R1,BM_I, DIRstr, R1, DIRstr,
BM_OUTPUT1))
os.system('blockmedian -R%s -I%s -V -Q %s\\%s > %s\\%s' % (BM_R2,BM_I, DIRstr, R2, DIRstr,
BM_OUTPUT2))
os.system('blockmedian -R%s -I%s -V -Q %s\\%s > %s\\%s' % (BM_R3,BM_I, DIRstr, R3, DIRstr,
BM_OUTPUT3))
os.system('blockmedian -R%s -I%s -V -Q %s\\%s > %s\\%s' % (BM_R4,BM_I, DIRstr, R4, DIRstr,
BM_OUTPUT4))
#os.system('blockmedian -R%s -I%s -V -Q %s\\%s > %s\\%s' % (BM_R,BM_I, DIRstr, DATAstr, DIRstr, BM_OUTPUT))
#If only one region is used, the lines above should be commented out and this line used instead.

#####
# Point 6 in the explanation. Merge all the block median data into one file
#####
I=open(r'%s\\%s' % (DIRstr,BM_OUTPUT), 'w+' )
H=open('%s%s' % (DIRstr,BM_OUTPUT1), 'r' )
while 1:

```

```
    line=H.readline()
    if not line: break
    I.write(line)
H.close()

J=open('%s%s' % (DIRstr,BM_OUTPUT2), 'r' )
while 1:
    line=J.readline()
    if not line: break
    I.write(line)
J.close()

K=open('%s%s' % (DIRstr,BM_OUTPUT3), 'r' )
while 1:
    line=K.readline()
    if not line: break
    I.write(line)
K.close()

L=open('%s%s' % (DIRstr,BM_OUTPUT4), 'r' )
while 1:
    line=L.readline()
    if not line: break
    I.write(line)
L.close()

I.close()

#####
# Point 7 in the explanation, see function in the beginning of the script.
#####

grid()
```

Appendix 2: Python script II: the remove-restore procedure

The following script details the procedure for adding the higher resolution source data sets, such as multibeam, dense single beam echo soundings and land topography on top of the 'base grid' using the remove-restore method

The script is written in Python and uses embedded GMT routines.

```
# -*- coding: cp1252 -*-
#
# GEBCO Cook Book Appendix 2 "Step 2 in the process of gridding the International Bathymetric Chart of the
# Arctic Ocean (IBCAO) Version 3.0"
#
# This script is stage two in the procedure used in generating IBCAO 3.0. It uses embedded GMT routines.
# The script uses a number of variables which are setup in Point 8. These example values were used to grid
# IBCAO 3.0. The user should modify these variables to match their own gridding project.
#
# The script will perform the following:
# 8. Setup of the variables
# 9. Creation of an input file for gridding
# 10. Segment the data into regions to handle large data amounts with GMT "blockmedian"
# 11. Block median filtering
# 12. Merge block median filtered segments into one file
# 13. Find the depth in the 'base grid' at the location of the block median filtered data points
# 14. Compute the difference in z-values between the block median data and the base grid
# 15. Create a difference grid
# 16. Merge the difference grid on top of the base grid
#
# This script originated from the remove-restore script written by D. Sandwell 08/08/07
# Written by Martin Jakobsson November 27 2011
#
#
#
#
from __future__ import division #This line includes the true division avoiding problems with unwanted floor
division
import fileinput
import os

#####
# Point 8: Setup of the variables
#####

DIRstr='C:\\IBCAOData\\' #Directory path to the data files, change to your path
BM_R='-2904000/2904000/-2904000/2904000' #Blockmedian region set in GMT, this must fit the
geographic extent of the grid which is going to be updated
```

#It could be any coordinate system, the main point is that the region fits the geographic region of the base grid to be updated

#The following are the output files from the Blockmedian filtering from each of the segmented regions for use in remove restore

```
BM_RR_OUTPUT1='OUTFILE_RR_BM_1.xyz'  
BM_RR_OUTPUT2='OUTFILE_RR_BM_2.xyz'  
BM_RR_OUTPUT3='OUTFILE_RR_BM_3.xyz'  
BM_RR_OUTPUT4='OUTFILE_RR_BM_4.xyz'
```

```
BM_I='500' # Blockmedian filter bin size, this should be the same as the cell size of the resampled base grid.  
IBCAO_resamp='resamp_grd01.grd' #The base grid  
IBCAO_RR='IBCAO_RR.xyz' #The input ASCII file of all multibeam and dense single beam echo soundings and land topography.  
IBCAO_RR_SEGMENT='IBCAO_RR_SEGMENT.xyz' #This is a file that consists of all merged blockmedian files.
```

```
IBCAO_resamp_predict='resamp_grd01_pred.xyyz' #This is the interpolated values output from grdtrack  
IBCAO_resamp_diff='IBCAO_diff.xyz' #Points that are different when from the old IBCAO after check with grdtrack against the new data  
IBCAO_resamp_diff_GRD='IBCAO_diff.grd'  
IBCAO_final='IBCAO_final_RR.grd' #The final grid file  
DIFF_P='0.5' #the difference criteria that need to be passed for updating of grid. In other words, the data sets need to be different by at least this amount for an update to take place
```

```
S_C='0.001' #Iteration parameter  
S_T='0.32' #Tension variable for use with the GMT surface gridding command
```

#In order to handle large volumes of data with Blockmedian, it may be necessary to cut the full area into sections. The user must change the values given here to those appropriate for their own gridding project. Values can be set in any coordinate system or latitude or longitude if a geographic grid is created. Note that this region should extend slightly outside of the final grid boundaries to account for edge effects.

```
BM_R1='0/2910000/0/2910000' #Region 1 for subset tiling. This tiling is only required for very large data sets (100 million soundings or more).  
BM_R2='0/2910000/-2910000/0' #Region 2 for subset tiling  
BM_R3='-2910000/0/-2910000/0' #Region 3 for subset tiling  
BM_R4='-2910000/0/0/2910000' #Region 4 for subset tiling
```

#Output files from the subset tiling

```
R1='R1_RR.xyz'  
R2='R2_RR.xyz'  
R3='R3_RR.xyz'  
R4='R4_RR.xyz'
```

```
#####  
# Point 9: Creation of an input file for gridding  
#####
```

```

os.system('set EMM=RAM')
os.system('set dos=high, umb')
DATAstr=IBCAO_RR
FILElist=["file1_SB_dense.xyz','file2_MB.xyz','file4_TOPO.xyz"] #All input files should be listed
here.
print '%s' % (FILElist)
F=open(r'%s\\%s' % (DIRstr,DATAstr), 'w+' )
Cint=0
while Cint <= len(FILElist)-1:
    G=open('%s%s' % (DIRstr,FILElist[Cint]), 'r' )
    while 1:
        line=G.readline()
        line_items=line.split()
        if not line: break
        if len(line_items) == 3:
            F.write(line)
    Cint +=1
    G.close()

#####
# Point 10: Segment the data into regions to handle large data amounts with GMT "blockmedian"
#####

os.system('gmtselect -R%s -V %s\\%s > %s\\%s' % (BM_R1,DIRstr, DATAstr, DIRstr, R1))
os.system('gmtselect -R%s -V %s\\%s > %s\\%s' % (BM_R2,DIRstr, DATAstr, DIRstr, R2))
os.system('gmtselect -R%s -V %s\\%s > %s\\%s' % (BM_R3,DIRstr, DATAstr, DIRstr, R3))
os.system('gmtselect -R%s -V %s\\%s > %s\\%s' % (BM_R4,DIRstr, DATAstr, DIRstr, R4))

#####
# Point 11: Block median filtering
#####

os.system('blockmedian -R%s -I%s -V -Q %s\\%s > %s\\%s' % (BM_R1,BM_I, DIRstr, R1, DIRstr,
BM_RR_OUTPUT1))
os.system('blockmedian -R%s -I%s -V -Q %s\\%s > %s\\%s' % (BM_R2,BM_I, DIRstr, R2, DIRstr,
BM_RR_OUTPUT2))
os.system('blockmedian -R%s -I%s -V -Q %s\\%s > %s\\%s' % (BM_R3,BM_I, DIRstr, R3, DIRstr,
BM_RR_OUTPUT3))
os.system('blockmedian -R%s -I%s -V -Q %s\\%s > %s\\%s' % (BM_R4,BM_I, DIRstr, R4, DIRstr,
BM_RR_OUTPUT4))
F.close()

#####
# Point 12: Merge the blockmedian filtered segments
#####

DATAstr2=IBCAO_RR_SEGMENT
L=open(r'%s\\%s' % (DIRstr,DATAstr2), 'w+' )
FILElist2=['OUTFILE_RR_BM_1.xyz','OUTFILE_RR_BM_2.xyz','OUTFILE_RR_BM_3.xyz','OUTFILE_RR_B
M_4.xyz']
Cint2=0
while Cint2 <= len(FILElist2)-1:
    K=open('%s%s' % (DIRstr,FILElist2[Cint2]), 'r' )

```

```

while 1:
    line=K.readline()
    line_items=line.split()
    if not line: break
    if len(line_items) == 3:
        L.write(line)
Cint2 +=1
K.close()

L.close()

#####
# Point 13: Find the depth in the 'base grid' at the location of the blockmedian filtered data points
#####
#Find the depth in the base grid at the location of the blockmedian filtered data points.

os.system('grdtrack %s -G%s -V -S > %s' %
(IBC AO_RR_SEGMENT,IBC AO_resamp,IBC AO_resamp_predict))

#####
# Point 14: Compute the difference in z-values between the blockmedian data and the base grid
#####

I=open('%s' % (IBC AO_resamp_diff), 'w+' )
H=open('%s' % (IBC AO_resamp_predict), 'r' )
while 1:
    line2=H.readline()
    if not line2: break
    X_str,Y_str,Z1_str,Z2_str=line2.split()
    X_f=float(X_str)
    Y_f=float(Y_str)
    Z1_f=float(Z1_str)
    Z2_f=float(Z2_str)
    DIFF_1=Z2_f-Z1_f
    DIFF_2=Z1_f-Z2_f
    DIFF_P_f=float(DIFF_P)
    if DIFF_1 > DIFF_P_f or DIFF_2 > DIFF_P_f:
        I.write('%s %s %s\n' % (X_str,Y_str,DIFF_2))
I.close()

#####
# Point 15: Create a difference grid
#####

#Create a grid using the GMT nearneighbor routine, that consist of the differences between the blockmedian
filtered data and the base grid

os.system('nearneighbor %s -G%s -R%s -I%s -S1000 -N4 -E0 -V' %
(IBC AO_resamp_diff,IBC AO_resamp_diff_GRD,BM_R,BM_I))

#####
# Point 16: Merge the difference grid on top of the base grid

```

```
#####
```

```
#This step adds the difference grid on top of the base grid using grdmath from GMT
```

```
os.system('grdmath %s %s ADD = %s' % (IBCAO_resamp,IBCAO_resamp_diff_GRD,IBCAO_final))
```

```
###
```

```
### clean up the mess
```

```
###
```

```
##rm global.grd diff.grd
```

```
import fileinput
```

Appendix 3: IBCAO Compilation Team

¹Martin Jakobsson, ²Larry Mayer, ³Bernard Coakley, ⁴Julian A. Dowdeswell, ⁵Steve Forbes,

⁶Boris Fridman, ⁷Hanne Hodnesdal, ⁸Riko Noormets, ⁹Richard Pedersen, ¹⁰Michele Rebesco

¹¹Hans-Werner Schenke, ¹²Yulia Zarayskaya, ¹⁰Daniela Accettella, ²Andrew Armstrong,

¹³Robert M. Anderson, ¹⁴Paul Bienhoff, ¹⁵Angelo Camerlenghi, ¹⁶Ian Church, ¹⁷Margo Edwards,

²James V. Gardner; ¹⁸John K. Hall, ¹Benjamin Hell, ¹⁹Ole Hestvik, ²⁰Yngve Kristoffersen,

²¹Christian Marcussen, ¹Rezwan Mohammad, ²David Monahan, ²²David Mosher, ²³Son V.

Nghiem, ¹⁵Maria Teresa Pedrosa, ⁵Paola G. Travaglini, ²⁴Pauline Weatherall;

¹Dept. of Geological Sciences, Stockholm University, Sweden; ²Center for Coastal and Ocean Mapping/Joint Hydrographic Center, University of New Hampshire, USA; ³Dept. of Geology and Geophysics, University of Alaska Fairbanks, USA; ⁴Scott Polar Research Institute, University of Cambridge, UK; ⁵Canadian Hydrographic Service, Canada; ⁶Moscow Aerogeodetic Company, Russian Federation; ⁷Norwegian Mapping Authority, Hydrographic Service, Norway; ⁸The University Centre in Svalbard, Longyearbyen, Norway; ⁹National Survey and Cadastre, Denmark; ¹⁰Istituto Nazionale di Oceanografia e di Geofisica Sperimentale (OGS), Italy; ¹¹Alfred Wegener Institute for Polar and Marine Research (AWI), Germany; ¹²Laboratory of Ocean Floor Geomorphology and Tectonics, Geological Institute RAS, Russian Federation; ¹³Science Applications International Corporation, USA; ¹⁴Johns Hopkins University Applied Physics Laboratory, USA; ¹⁵ICREA and University of Barcelona, Spain; ¹⁶Dept. Geodesy and Geomatics Engineering, University of New Brunswick, Canada; ¹⁷University of Hawaii at Manoa, USA; ¹⁸Geological Survey of Israel, Israel; ¹⁹OLEX, Norway; ²⁰Dept of Earth Science, University of Bergen, Norway; ²¹Geological Survey of Denmark and Greenland, Denmark; ²²Geological Survey of Canada, Canada; ²³Jet Propulsion Laboratory, California Institute of Technology, USA; ²⁴British Oceanographic Data Centre (BODC), UK.

8.3 Testing of gridding methods

In order to test different gridding methods, it is necessary to compare the resulting grid with control data that were not used to make the grid. These control data may have been intentionally withheld for testing purposes, or they may not have been available when the grid was calculated. The differences between the control data and the grid are considered to be "errors," which can be quantified and compared to assess how well a gridding method does.

8.3.1 Distance to Control

Contributed by K. M. Marks, NOAA Laboratory for Satellite Altimetry, USA

We have developed a method that can be used to test different gridding algorithms. It has been used previously to assess errors in bathymetry models (Marks and Smith, 2010). The method can also be used to assess errors in any local or regional depth grids where there are multibeam or other “ground truth” depths available to compare the grids against. The “ground truth” data must not be incorporated into the depth grid for the technique to work, and there needs to be an area with a large gap between control points for testing. This method can also be used to evaluate different gridding techniques. A successful gridding algorithm will have smaller errors when compared to the ground truth data.

We demonstrate the use of the error assessment method to evaluate different gridding algorithms. For this example, following NOAA Technical Report NESDIS 132 (Marks and Smith, 2011), we select a small study area encompassing several seamounts (left panel in Figure 8.7) that has large gaps between control points and is traversed by several swaths of JAMSTEC multibeam data that can serve as “ground truth.” Figure 8.7 (right panel) shows a distance to control map that was calculated from control points in bathymetry model version 12.1*. Version 12.1* had JAMSTEC data intentionally withheld from bathymetry model version 12.1 (Smith and Sandwell, 1997) for testing purposes.

Distance to control may be calculated in two ways. Smith wrote a program (Appendix C; Marks and Smith, 2011) exploiting the even/odd encoding of control points in Smith and Sandwell bathymetry models to compute a distance to control grid directly from the model “img” file. However, distance to control may be calculated from any control points using the GMT routine “grdmath” with the PDIST operator. The command line for calculating distance to control from any user-supplied control points is listed below. This will enable users to test any bathymetry grids for errors as a function of distance to control.

```
grdmath controlpoints.xy -Rminlon/maxlon/minlat/maxlat -lgrdspacing -fg PDIST = distance_grd
```

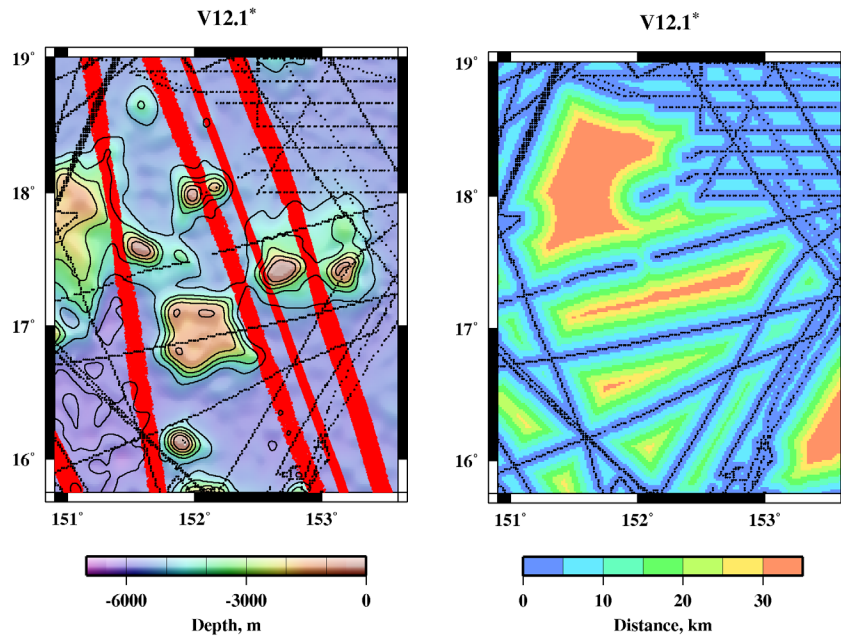

Figure 8.7 JAMSTEC multibeam swaths (red) plotted on bathymetry version 12.1* (left). Map of “distance to control” corresponding to bathymetry version 12.1* (right). Black dots are V12.1* grid cells constrained by ship soundings. V12.1* was created without JAMSTEC data.

In our example here we used depth values from the constrained grid cells from V12.1* in the study area as input into different gridding algorithms: GMT routine “surface,” employed with the tension set to “0” and set to “1,” and GMT routine “nearneighbor.” Surface tension set to “0” gives the minimum curvature solution, and set to “1” gives a harmonic surface where maxima and minima are only possible at control points. “Nearneighbor” uses a nearest neighbor algorithm to assign an average value within a radius centered on a node. The GMT command lines used to produce the gridding solutions shown in Figure 8.8 are listed below.

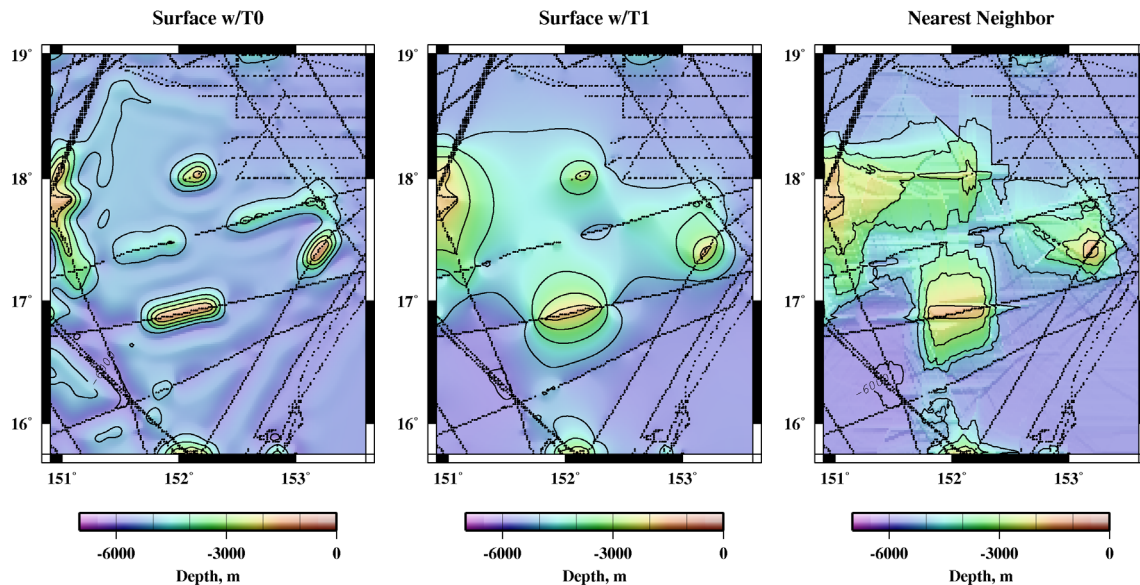

Figure 8.8 Results of gridding depths from V12.1* at constrained grid cells (black dots): GMT “surface” gridding routine with tension set to 0 (left) and set to 1 (middle), and “nearneighbor” gridding routine (right).

```
surface topo_12.1.nojamstec.controls.xyz -R0/2.7/0/3.41666666667 -I1m -T0 -Gsurface.t0_grd
surface topo_12.1.nojamstec.controls.xyz -R0/2.7/0/3.41666666667 -I1m -T1 -Gsurface.t1_grd
nearneighbor topo_12.1.nojamstec.controls.xyz -R0/2.7/0/3.41666666667 -N4/1 -S100k -I1m
-Gnearneighbor.1m_grd
```

Each gridding algorithm produces a very different result. By comparing these results to the JAMSTEC multibeam “ground truth” data (red dots in Fig. 8.7, left panel), we can assess which algorithm produced the best match to the observed depths. Note that no interpolated solution detects seamounts in gaps between ship controls (Fig. 8.8). However altimetric bathymetry model V12.1* (Fig. 8.7, left panel) does detect seamounts in gaps between ship soundings. The model fills these gaps with depths estimated from satellite gravity, which reflects the underlying seafloor topography.

In Figure 8.9 we show the errors (i.e., the absolute value of the differences) between the JAMSTEC multibeam depths and depths produced by the different GMT gridding routines. In our example, GMT routine “surface” with a tension of 1 has the smallest errors.

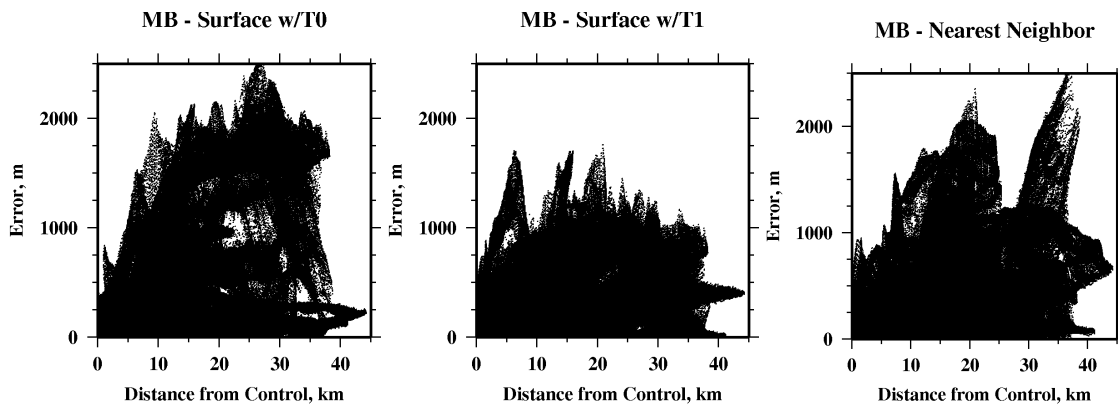

Figure 8.9 Errors are the absolute value of the differences between multibeam depths from swaths plotted in Figure 8.7 and gridded depths from GMT routines “surface” with tension set to 0 (left) and set to 1 (middle), and from GMT “nearneighbor” (right), plotted against distance from the nearest sounding control.

8.3.2 Histograms

The errors can also be displayed in the form of a histogram (Figure 8.10). The error distribution from gridding with GMT routine “surface” with tension set to 0 shows the largest errors and they are generally negative (depths from “surface” grid are deeper than multibeam depths).

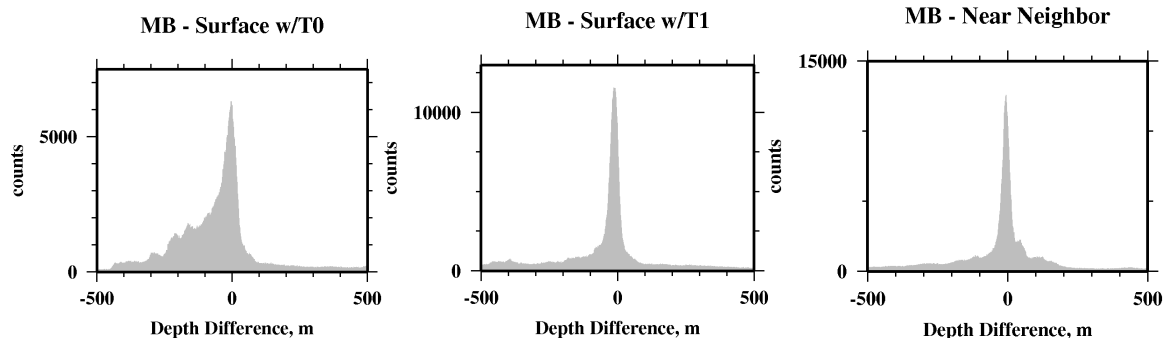

Figure 8.10 Histogram of the differences between multibeam depths from swaths plotted in Figure 8.7 and grids from GMT routines “surface” with tension set to 0 (left) and set to 1 (middle), and from GMT “nearneighbor” (right) depths.

It is also possible to map regional errors resulting from the different gridding algorithms. The interpolated grids (shown in Fig. 8.8) can be subtracted from a gridded solution that incorporated all the ship controls (in this example, bathymetry model V12.1). The pattern of regional depth differences (Fig. 8.11) can help in evaluating how well a gridding routine is doing.

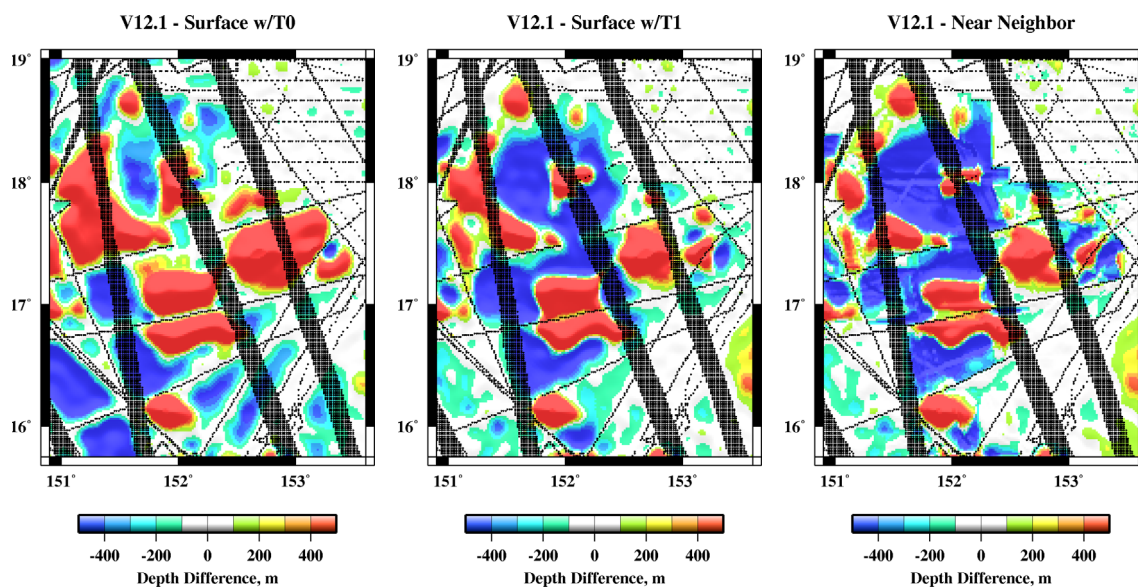

Figure 8.11 Regional depth differences between V12.1 and results from different GMT gridding routines (shown in Fig. 8.8). Black dots are constrained grid cells in V12.1.

REFERENCES

Marks K, Smith WHF (2010) Evolution of errors in the altimetric bathymetry model used by Google Earth and GEBCO. *Mar. Geophys. Res.*, 31:223-238, doi:10.1007/s11001-010-9102-0

Marks K, Smith WHF (2011) Assessing errors in altimetric and other bathymetry grids. NOAA Technical Report NESDIS 132, January, 2011

Smith WHF, Sandwell DT (1997) Global sea floor topography from satellite altimetry and ship depth soundings. *Science* 277:1956-1962. doi:10.1126/science.277.5334.1956

8.3.3 *Statistical tests*

TEXT IN PREPARATION

8.4 Other routines for use on gridded data

Contributed by Matthew Love and Barry Eakins, National Geophysical Data Center, USA, and David Sandwell, Scripps Institution of Oceanography, USA

Below are miscellaneous routines for use on gridded data. The routines include `gdal_query.py`, which compares gridded elevations with xyz data, `update_grid`, which updates a grid with new grid cell values, and `gdal_perspective.py`, which creates color-perspective images of DEMs.

gdal_query.py

This Python script uses GDAL (<http://www.gdal.org/>) to query a GDAL-readable grid, such as netcdf, at the locations of xyz data in a specified file. It returns an ASCII file with xyz of the original data, as well as the grid elevation value at each point and the difference between these values. This script is useful for quantifying how well the grid represents the source data it was built from, or compares with other, independent data that were not used in grid development. Developer - Matthew Love, NOAA National Geophysical Data Center.

```
#!/usr/bin/env python

# -
# Description: Compare the values found in a source 'xyz' ascii
#              file to those of a gdal compatible gridfile, or
#              sample a gridfile to xy points in an xy* file.
#
# Depends: GDAL ; NumPy
# -

#--
import sys
import os
import math
import re
import struct
import numpy as np
import osgeo.gdal as gdal
#--

gq_version = '1.8.2'

def con_dec(x, dec):
    '''Return a float string with n decimals
    (used for ascii output).'''

    if x is None:
        print >> sys.stderr, "gdal_query: Error, Attempting to convert a
'None' value."
        return
    fstr = "%. " + str(dec) + "f"
    return fstr % x

# Convert a geographic x,y value to a pixel location of geoTransform
```

```

def geo2pixel( geo_x, geo_y, geoTransform ):
    if geoTransform[2] + geoTransform[4] == 0:
        pixel_x = (geo_x - geoTransform[0]) / geoTransform[1]
        pixel_y = (geo_y - geoTransform[3]) / geoTransform[5]
    else:
        pixel_x, pixel_y = apply_gt( geo_x, geo_y,
invert_gt( geoTransform ) )
    return int(pixel_x), int(pixel_y)

# Convert a pixel location to geographic coordinates given geoTransform
def pixel2geo( pixel_x, pixel_y, geoTransform ):
    geo_x, geo_y = apply_gt( pixel_x, pixel_y, geoTransform )
    return geo_x, geo_y

def apply_gt( in_x, in_y, geoTransform ):
    out_x = geoTransform[0] + in_x * geoTransform[1] + in_y *
geoTransform[2]
    out_y = geoTransform[3] + in_x * geoTransform[4] + in_y *
geoTransform[5]
    return out_x, out_y

def invert_gt(geoTransform):
    det = geoTransform[1] * geoTransform[5] - geoTransform[2] *
geoTransform[4]
    if abs(det) < 0.0000000000000001:
        return
    invDet = 1.0 / det
    # compute adjoint and divide by determinate
    outGeoTransform = [0,0,0,0,0,0]
    outGeoTransform[1] = geoTransform[5] * invDet
    outGeoTransform[4] = -geoTransform[4] * invDet
    outGeoTransform[2] = -geoTransform[2] * invDet
    outGeoTransform[5] = geoTransform[1] * invDet
    outGeoTransform[0] = ( geoTransform[2] * geoTransform[3] -
geoTransform[0] * geoTransform[5] ) * invDet
    outGeoTransform[3] = ( -geoTransform[1] * geoTransform[3] +
geoTransform[0] * geoTransform[4] ) * invDet
    return outGeoTransform

def
query_gdal(inxyz,ingrd,delim,xloc,yloc,zloc,nodata,out_form,addit,return_a
ll,verbose):
    '''Compare an xyz file to a gdal-compatible grid file.'''

    if inxyz == sys.stdin:
        in_plot = inxyz
    else:
        in_plot = open(inxyz, 'r')

    # Process the grid file
    ds = gdal.Open(ingrd)
    comp_geot = ds.GetGeoTransform()
    band = ds.GetRasterBand(1)

```

```

# Load the grid into a numpy array
tgrid = band.ReadAsArray()
#except:
xyz_vs_gdal(inxyz,ingrd,delim,xloc,yloc,zloc,nodata,out_form,addit,return_
all,verbose)

# Get some grid info
if nodata is None: nodata = band.GetNoDataValue()
if nodata is None: nodata = -9999

cellsize = [float(comp_geot[1]), float(comp_geot[5])]
xextent = float(comp_geot[0])
yextent = float(comp_geot[3])

# Process the xyz file
n = 0
for i in in_plot:
    n+=1
    if verbose:
        print >> sys.stderr, "gdal_query: " + str(n), "\r",
    try:
        x = float(i.split(delim)[int(xloc)].strip())
        y = float(i.split(delim)[int(yloc)].strip())
        if zloc == '-':
            z = nodata
        else:
            z = float(i.split(delim)[int(zloc)].strip())

    except:
        print >> sys.stderr, "gdal_query: Failed to read
line: %s" %(i),
        x=xextent - 10
        y=yextent + 10

# Continue if values are reasonable.
if x > xextent and y < yextent:
    xpos,ypos = geo2pixel(x,y,comp_geot)
    #xpos = int(math.fabs(math.ceil((xextent -
x)/float(cellsize[0]))))
    #ypos = int(math.fabs(math.ceil((y -
yextent)/float(cellsize[1]*-1))))

# Locate the grid cell and get it's value
try: g = tgrid[ypos,xpos]
except: g = nodata

d = nodata
c = nodata
p = nodata
s = nodata

if g != nodata:
    d = z - g
    p = z + g

```

```

        # FIXME ## as d/g*100 would fail if g was zero
        if g == 0:
            g += 0.0000001
        # /FIXME ##
        # c is the percent difference
        c = con_dec(math.fabs(float(d/g*100)), 2)
        # s is the 'scaled' difference
        s = con_dec(math.fabs(d / (z + g)), 4)

    # Print out the results
    d = con_dec(d, 4)

    outs = []
    for i in out_form:
        outs.append(vars()[i])
    print(delim.join(map(str, outs)))
else:
    if return_all:
        d = nodata
        p = nodata
        c = nodata
        s = nodata
        g = nodata
        outs = []
        for i in out_form:
            outs.append(vars()[i])
        print(delim.join(map(str, outs)))
if verbose:
    print >> sys.stderr, "\n",

def Usage():
    print('Usage: gdal_query.py [-delimiter char] [-s_format "0,1,2"] ')
    print('                    [-d_format "xyzgdps"] [-d_nodata value] [-')
    print('                    [-return_all] [-verbose]')
    print('                    grdfilename [srcfile]')
    print('')
    print('Input options:')
    print('  grdfilename\tSpecifies which gdal-compatible grid file in which')
    print('to ')
    print('  \t\tquery values.')
    print('  srcfile\tSpecifies which xy* file in which to query grdfilename')
    print('with,')
    print('  \t\tif not given, will read from standard input.')
    print('  -delimiter\tSpecifies the input xy* delimiter')
    print('  -s_format\tSpecifies the input xy* format, a quoted triplet')
    print('specifying')
    print('  \t\twhere the x,y and z values are located.')
    print('  \t\tIf there is no input z value, specify with a -, i.e. ')
    print('  \t\t-s_format "0,1,-"')
    print('')
    print('Output options:')
    print('  -d_format\tSpecifies the output xy* format, a quoted string')
    print('specifying ')

```

```

    print(' \t\twhich output values to return.')
    print(' \t\tOptions are x,y,z,g,d,p,c,s; where z is the input z
value, g is the grid ')
    print(' \t\tz value, d is the difference between the input z value
and grid')
    print(' \t\tz value, p is the product of the input z value and the
grid z value,')
    print(' \t\tc is the percetage difference and s is the scaled
difference.')
    print(' -d_nodata\tSpecifies the output nodata value, will use the
nodata value from')
    print(' \t\tthe input grid if not specified.')
    print(' -header\tIndicates that the output will have a header
included, default is False.')
    print(' -return_all\tWill prompt the return of all input points,
regardless of location')
    print(' \t\twhen compared to the input grid file, with grid values
considered as nodata.')
    print('')
    print('General options:')
    print(' -verbose\tWill increase verbosity.')
    print('')
    print('Example:')
    print('To query grd.tif with an ascii xy file (values.xy) with comma
delimited fields and ')
    print('no z-value and return the xy values from the input xy file and
the z values')
    print('from grd.tif:')
    print('gdal_query.py -delimiter "," -s_format "0,1,-" -d_format "xyg"
grd.tif values.xy > values.xyz')
    print('\ngdal_query v.%s' %(gq_version))
    sys.exit( 1 )

#
# Mainline
#
if __name__ == "__main__":

    inxyz=None
    ingrd=None
    delim=" "
    xyzf="0,1,2"
    out_xyzf="xyzg"
    xyzh=False
    addit=False
    verbose=False
    return_all=False
    out_nodata=None

    gdal.AllRegister()
    argv = gdal.GeneralCmdLineProcessor( sys.argv )
    if argv is None:
        sys.exit(0)

    # Parse command line arguments.

```

```

i = 1
while i < len(argv):
    arg = argv[i]

    if arg == '-delimiter':
        delim = argv[i+1]
        i = i + 1

    elif arg == '-s_format':
        xyzf = str(argv[i+1])
        i = i + 1

    elif arg == '-d_format':
        out_xyzf = str(argv[i+1])
        i = i + 1

    elif arg == '-d_nodata':
        out_nodata = float(argv[i+1])
        i = i + 1

    elif arg == '-header':
        xyzh = True

    elif arg == '-addition':
        addit = True

    elif arg == '-verbose':
        verbose = True

    elif arg == '-return_all':
        return_all = True

    elif arg[0] == '-':
        Usage()

    elif ingr is None:
        ingr = arg

    elif inxyz is None:
        inxyz = arg

    else:
        Usage()

    i = i + 1

if inxyz == None:
    inxyz = sys.stdin
if ingr == None:
    Usage()
    sys.exit(0)

#-- Parse point locations.
xloc = xyzf.split(",")[0].strip()

```

```
yloc = xyzf.split(",")[1].strip()
zloc = xyzf.split(",")[2].strip()

out_form = tuple(re.findall(r'(\D)', out_xyzf))

if xyzh == True:
    outs = []
    for i in out_form:
        outs.append(i)
    print delim.join(outs)

query_gdal(inxyz, ingrd, delim, xloc, yloc, zloc, out_nodata, out_form, addit, return_all, verbose)
#--END
```

update_grid

This csh script uses GMT (<http://gmt.soest.hawaii.edu/>) to update a GMT readable grid with new data from a specified xyz file. The new grid created will have elevation values representative of the new data, not the values in the original grid. Cells without new data will retain the values of the original grid. This script is useful for quickly improving a pre-compiled grid with new, trusted data. Developer – David Sandwell, Scripps Institution of Oceanography.

```
#!/bin/csh
# D. Sandwell 08/08/07
#
# Update the topography grid using some new trusted data.
#
# check the number of arguments
#
if ($#argv < 9) then
  echo " Usage: update_grid topo.xyz topo_old.grd lon0 lonf lat0 latf dlon
dlat edit"
  echo "      topo.xyz    - file of lon, lat, depth (neg meters)"
  echo "      topo_old.grd - existing low resolution grid of topography"
  echo "      lon0          - left boundary of output grid (0-360)"
  echo "      lonf          - right boundary of output grid (0-360)"
  echo "      lat0          - lower boundary of output grid"
  echo "      latf          - upper boundary of output grid"
  echo "      dlon          - longitude spacing of output grid
(e.g., .001)"
  echo "      dlat          - latitude spacing of output grid"
  echo "      edit          - remove |differences| > edit"
  echo " "
  echo "Example: update_grid german_iceland.xyz topo_old.grd 340 343 65
68 .01 .01"

  exit 1
endif
#
# first blockmedian the input data to make the file smaller
#
blockmedian $1 -R$3/$4/$5/$6 -I$7/$8 > block.xyz
#
# make a matching grid from the global topo
#
grd2xyz $2 -R$3/$4/$5/$6 -S > global.xyz
surface global.xyz -R$3/$4/$5/$6 -I$7/$8 -T.00 -V -Gglobal.grd
#
# interpolate the new data through the old grid
#
grdtrack block.xyz -Gglobal.grd -S > predict.xyzz
#
awk '{if(!(($4-$3) > '$9' || ($3-$4) > '$9')) print($1, $2, $3-$4)}' <
predict.xyzz > block.xyd
#
```

```
# now make the difference grid
#
surface block.xyd -R$3/$4/$5/$6 -I$7/$8 -T.35 -V -Gdiff.grd
#
# add the two grids
#
grdmath global.grd diff.grd ADD = final_topo.grd
#
# clean up the mess
#
rm global.grd diff.grd
```

gdal_perspective.py

This Python script uses GDAL (<http://www.gdal.org/>), ImageMagick (<http://imagemagick.org>) and PovRay (<http://povray.org>) to generate a color perspective image of a GDAL-readable grid, such as netCDF or GeoTiff. This script is useful for generating quality perspective images of grids for use in DEM development as a tool for QA/QC and for reporting and visualization of the final DEM product. Developer - Matthew Love, NOAA National Geophysical Data Center.

```
#!/usr/bin/env python

import sys
import os
import math
from osgeo import gdal
import numpy as np

gp_version = '0.0.2'

gg_equat = 111321.543

## Colors
trs = (-11000,-10500,-10000,-9500,-9000,-8500,-8000,-7500,-7000,
       -6500,-6000,-5500,-5000,-4500,-4000,-3500,-3000,-2500,-2000,
       -1500,-1000,-500,-0.001,0,100,200,500,1000,1500,2000,2500,3000,
       3500,4000,4500,5000,5500,6000,6500,7000,7500,8000)

colors =
([10,0,121],[26,0,137],[38,0,152],[27,3,166],[16,6,180],[5,9,193],
 [0,14,203],[0,22,210],[0,30,216],[0,39,223],[12,68,231],[26,102,240],
 [19,117,244],[14,133,249],[21,158,252],[30,178,255],[43,186,255],[55,193,2
55],
 [65,200,255],[79,210,255],[94,223,255],[138,227,255],[138,227,255],
 [51,102,0],[51,204,102],[187,228,146],[255,220,185],[243,202,137],[230,184
,88],
 [217,166,39],[168,154,31],[164,144,25],[162,134,19],[159,123,13],[156,113,
7],
 [153,102,0],[162,89,89],[178,118,118],[183,147,147],[194,176,176],[204,204
,204],
      [229,229,229],[138,227,255],[51,102,0])

elevs = [-20,-19.09090909,-18.18181818,-17.27272727,-16.36363636,-
15.45454545,
      -14.54545455,-13.63636364,-12.72727273,-11.81818182,-10.90909091,
```

```

        -10,-9.090909091,-8.181818182,-7.272727273,-6.363636364,-
5.454545455,
        -4.545454545,-3.636363636,-2.727272727,-1.818181818,-
0.909090909,-0.001,
        0,48.06865898,96.13731797,240.3432949,480.6865898,721.0298848,
961.3731797,1201.716475,1442.05977,1682.403064,1922.746359,2163.089654,
2403.432949,2643.776244,2884.119539,3124.462834,3364.806129,3605.149424,
3845.492719]

```

```

def scale_el(value, min, max, tr):
    if value > 0 and max > 0:
        return (max * tr) / 8000
    elif value < 0 and min < 0:
        return (min * tr) / -11000
    elif value == 0:
        return 0
    else: return None

```

```

def make_cpt(ingrd, grdmm):
    out_file = "%s.cpt" %(ingrd)
    out_cpt = open(out_file, 'w')

    ## NoData
    nd = returnNoData(ingrd)
    nd_string = str(nd) + " 0 0 0\n"
    out_cpt.write(nd_string)

    for i,j in enumerate(elevs):
        elevs[i] = scale_el(elevs[i], grdmm[4], grdmm[5], trs[i])
        if elevs[i] != None:
            outs = elevs[i],colors[i][0],colors[i][1],colors[i][2]
            #print outs
            out_cpt.write(" ".join(map(str, outs)))
            out_cpt.write("\n")

```

```

## Get min/max info about `ingrd'
def returnMinMax(ingrd):
    # Process the grid file
    ds = gdal.Open(ingrd)
    comp_geot = ds.GetGeoTransform()

    cellsize = [float(comp_geot[1]), float(comp_geot[5])]
    xmin = float(comp_geot[0])
    ymax = float(comp_geot[3])
    #nodata = ds.GetRasterBand(1).GetNoDataValue()
    #print xmin,ymax

    band = ds.GetRasterBand(1)
    nodata = band.GetNoDataValue()
    tgrid = band.ReadAsArray()

    #tgrid[tgrid==nodata]=float('nan')

```

```

#outarray[np.isnan(outarray)]=ndata
if np.isnan(nodata):
    tgrid=np.ma.MaskedArray(tgrid, mask=(np.isnan(tgrid)))
else:
    tgrid=np.ma.MaskedArray(tgrid, mask=(tgrid==nodata))

#print comp_geot
xs = ds.RasterXSize
ys = ds.RasterYSize
zmin = tgrid.min()
zmax = tgrid.max()

xmax = xmin + (cellsize[0] * xs)
ymax = ymin + (cellsize[1] * ys)
return [xmin, xmax, ymin, ymax, zmin, zmax, xs, ys]

def returnNoData(ingrd):
    ds = gdal.Open(ingrd)
    return ds.GetRasterBand(1).GetNoDataValue()

def degree2radian(deg):
    return (deg/180.0) * math.pi

def radian2degree(rad):
    return (rad/math.pi) * 180.0

def latlonlen(lat):
    lonlen = math.cos(degree2radian(lat)) * gg_equat
    latlen = 1 * gg_equat
    return [lonlen, latlen]

def pre_perspective(ingrd, grdmm, cpt):
    gd_translate = "gdal_translate -ot UInt16 -of PNG -scale %s %s 0
65535 %s temp.png\n\
gdal_translate -srcwin 1 1 %s %s -of PNG temp.png dem_16bit.png\n\
gdaldem color-relief %s %s temp2.tif\n\
gdal_translate -srcwin 1 1 %s %s temp2.tif rgb.tif\n\
rm temp.* temp2.*\n\
convert -transparent \"rgb(0,0,0)\" rgb.tif rgb.png\n\
convert -size 10000 dem_16bit.png dem_16bit_10000.png\n\
convert -transparent \"rgb(0,0,0)\" -size 10000 rgb.png
rgb_10000.png\n" %(grdmm[4], grdmm[5], ingrd,

grdmm[6]-2, grdmm[7]-2, ingrd,

cpt, grdmm[6]-2, grdmm[7]-2)
    return gd_translate

def povray_template(ingrd, grdmm, options):
    lllen = latlonlen(grdmm[2])
    povr_out = "%s.pov" %(ingrd)
    povr_file = open(povr_out, 'w')
    povr_file.write("// DEM\n\
\n\

```

```

//global_settings { assumed_gamma 2.2 }\n\
\n\
#include \"colors.inc\"\n\
\n\
#declare Bi = 2;\n\
\n\
//\n\
// Custom parameters start here\n\
//\n\
#declare rgb_image = \"rgb.png\"\n\
#declare dem_image = \"dem_16bit.png\"\n\
\n\
#declare xdim = %s; //number of pixels in X-direction\n\
#declare ydim = %s; //number of pixels in y-direction\n\
#declare max_y = %s; //maximum latitude extent\n\
#declare min_y = %s; //minimum latitude extent\n\
#declare min_z = %s; //minimum elevation\n\
#declare max_z = %s; //maximum elevation\n\
\n\
// Obtained from http://www.csgnetwork.com/degreenllavcalc.html \n\
#declare deg_lat_len = %s; //length of a degree of latitude in meters \n\
#declare deg_lon_len = %s; //length of a degree of longitude in meters\n\
\n\
// Position of camera \n\
#declare cam_azimuth = %s;\n\
#declare cam_elevation = %s;\n\
#declare cam_distance = %s; \n\
#declare cam_view_angle = %s;\n\
\n\
// Position of the \"sun\" \n\
#declare light_azimuth = cam_azimuth+90;\n\
#declare light_elevation = %s;\n\
#declare light_distance = %s; \n\
\n\
#declare vertical_exaggeration = %s;\n\
//\n\
// Custom parameters end here\n\
//\n\
\n\
#declare lon_scale = deg_lon_len / deg_lat_len;\n\
#declare z_scale = (100 * (max_z - min_z)) / (deg_lat_len * (max_y -
min_y));\n\
\n\
#declare cam_x = cam_distance * cos(radians(cam_elevation)) *
sin(radians(cam_azimuth));\n\
#declare cam_y = cam_distance * sin(radians(cam_elevation));\n\
#declare cam_z = cam_distance * cos(radians(cam_elevation)) *
cos(radians(cam_azimuth));\n\
#declare light_x = light_distance * cos(radians(light_elevation)) *
sin(radians(light_azimuth));\n\
#declare light_y = light_distance * sin(radians(light_elevation));\n\
#declare light_z = light_distance * cos(radians(light_elevation)) *
cos(radians(light_azimuth));\n\
\n\

```

```

#declare Texture0 = // Color elevation image (24-bit RGB PNG)\n\
texture {\n\
  pigment{\n\
    image_map { \n\
      png_rgb_image map_type 0 once interpolate Bi \n\
    } \n\
  } \n\
  finish { ambient 0.4 diffuse 0.8 } \n\
  rotate x*90 \n\
}\n\
\n\
\n\
height_field { // Unsigned 16-bit PNG DEM\n\
  png_dem_image \n\
  smooth\n\
  clipped_by {box { <0, 0, 0>, <0.999, 1, 0.999> } }\n\
  texture { Texture0 }\n\
  translate <-0.5, 0, -0.5>\n\
  scale <100*lon_scale*xdim/ydim,\n\
    vertical_exaggeration*z_scale, //Vertical exaggeration\n\
    100>\n\
} \n\
\n\
\n\
camera {\n\
  angle cam_view_angle\n\
  location <cam_x, cam_y, cam_z>\n\
  look_at <0, 0, 0> \n\
}\n\
\n\
light_source { <light_x, light_y, light_z> color White shadowless
parallel }\n\
  \n\
background { White } \n\
" %(grdmm[6],grdmm[7],grdmm[3],
  grdmm[2],grdmm[4],grdmm[5],
  lllen[0],lllen[1],options[0],
  options[1],options[2],options[3],
  options[4],options[5],options[6])
povr_file.close()
# print('\ngdal_perspective v.%s' %(gp_version))
def Usage():
  print('')
  print('gdal_perspective.py srcfile [-width n] [-height n]')
  print('          [-azimuth n] [-elevation n]')
  print('          [-distance n] [-view-angle n]')
  print('          [-light-elevation n] [-light-distance n]')
  print('          [-vertical-exaggeration n] [-cpt n] [-q]')
  print('')
  sys.exit( 1 )

if __name__ == "__main__":
  ingrd=None

```

```
pov_wid=1000
pov_height=800
pov_azimuth=130
pov_elevation=27
pov_distance=235
pov_view_angle=35
pov_light_elevation=30
pov_light_distance=10000
pov_vertical_exag=2
quiet=False
user_cpt=None

gdal.AllRegister()
argv = gdal.GeneralCmdLineProcessor( sys.argv )
if argv is None:
    sys.exit(0)

# Parse command line arguments.
i = 1
while i < len(argv):
    arg = argv[i]

    if arg == '-width':
        pov_wid = sys.argv[i+1]
        i = i + 1

    elif arg == '-height':
        pov_height = sys.argv[i+1]
        i = i + 1

    elif arg == '-azimuth':
        pov_azimuth = sys.argv[i+1]
        i = i + 1

    elif arg == '-view-angle':
        pov_view_angle = sys.argv[i+1]
        i = i + 1

    elif arg == '-elevation':
        pov_elevation = sys.argv[i+1]
        i = i + 1

    elif arg == '-distance':
        pov_distance = sys.argv[i+1]
        i = i + 1

    elif arg == '-light-elevation':
        pov_light_elevation = sys.argv[i+1]
        i = i + 1

    elif arg == '-light-distance':
        pov_light_distance = sys.argv[i+1]
        i = i + 1
```

```

elif arg == '-vertical-exaggeration':
    pov_vertical_exag = sys.argv[i+1]
    i = i + 1

elif arg == '-cpt':
    user_cpt = sys.argv[i+1]
    i = i + 1

elif arg == '-q':
    quiet = True

elif arg[0] == '-':
    Usage()

elif ingrd is None:
    ingrd = arg

else:
    Usage()

i = i + 1

if ingrd == None:
    Usage()
    sys.exit(0)

options=[pov_azimuth,pov_elevation,pov_distance,pov_view_angle,pov_light_e
levation,pov_light_distance,pov_vertical_exag]
if not quiet:
    print("gdal_perspective: Obtaining min/max values from grid")
    grdmm = returnMinMax(ingrd)
if not quiet:
    print("gdal_perspective: Generating CPT file")
if user_cpt is None:
    make_cpt(ingrd, grdmm)
    pp_sh = pre_perspective(ingrd,grdmm,"%s.cpt" %(ingrd))
else:
    pp_sh = pre_perspective(ingrd,grdmm,user_cpt)
povray_template(ingrd, grdmm, options)
povr_sh = "povray %s.pov +W%s +H%s" %(ingrd,pov_wid,pov_height)
if not quiet:
    print("gdal_perspective: processing grid file")
os.system(pp_sh)
#print pp_sh
if not quiet:
    print("gdal_perspective: processing pov-ray file")
os.system(povr_sh)
#print povr_sh
# Cleanup
os.system("rm rgb.* dem_*")
#--END

```

Chapter 9.0 Data Analysis Techniques

9.1 Computing Coherence on 2-D Grids

This chapter provides step-by-step instructions that will show a user how calculate the coherence between two-dimensional gravity and bathymetry grids.

Contributed by K. M. Marks, NOAA Laboratory for Satellite Altimetry, USA

9.1.1 What is Coherence?

Coherence is a measure of the linear correlation between two inputs. Coherence near one indicates a near perfect correlation of the two inputs, while coherence near zero indicates the absence of any significant relationship. A coherence of 0.5 can be interpreted as a signal-to-noise ratio of 1:1 in one input if the other can be assumed to be noise-free (Bendat and Piersol, 1986; Eq. 6.39). In the example here, the inputs are grids- one is multibeam bathymetry and the other marine gravity. One may expect a correlation between intermediate wavelength (~15-160 km) gravity and bathymetry anomalies, in accordance with isostatic compensation theory.

9.1.2 Data Grids

We demonstrate the coherence method on grids that lie on the northern flank of the Pacific-Antarctic spreading ridge and cover the Heirtzler fracture zone (Figure 9.1).

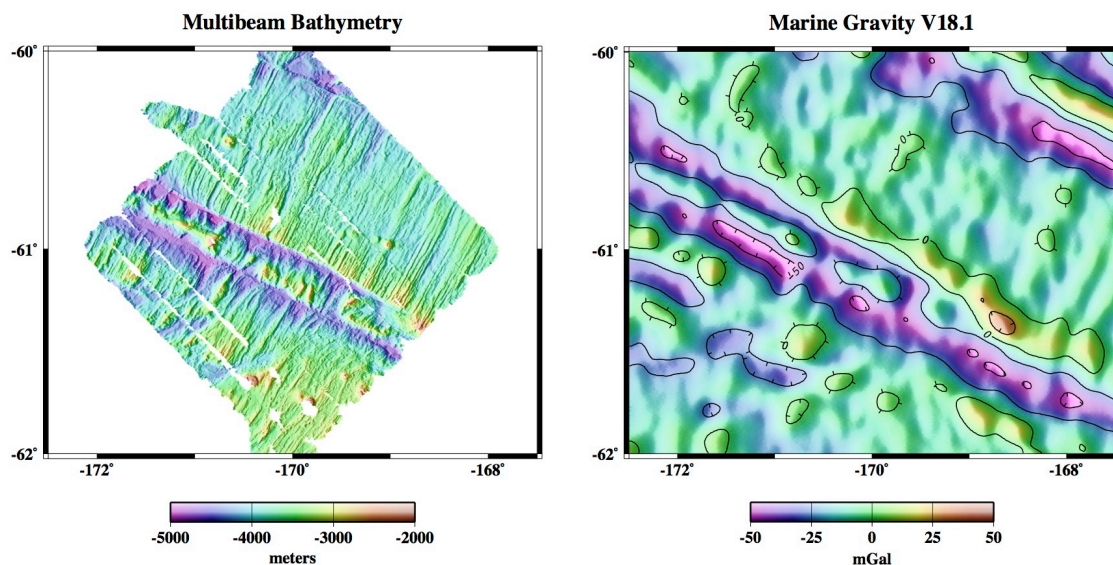

Figure 9.1 Multibeam bathymetry (left) and marine gravity (right) on the northern flank of the Pacific-Antarctic spreading ridge.

The multibeam bathymetry grid may be downloaded from the Lamont-Doherty Earth Observatory website using their Marine Geoscience Data System Geomapapp software (<http://www.geomapapp.org/index.htm>). The grid may be obtained on a geographic projection with a 200 m grid spacing.

The marine gravity anomaly grid (Sandwell and Smith, 1997, version 18.1) is available for download from the Scripps Institution of Oceanography website (http://topex.ucsd.edu/WWW_html/mar_grav.html). The gravity anomalies are derived from satellite altimeter data. The grid is on a Mercator projection with a 1-minute grid spacing.

9.1.3 Grid Preparation

The grids need to be prepared prior to computing the coherence. The grids are on different projections and have different grid spacings, and the multibeam survey is irregular in shape and inclined to the parallels and meridians. To correct for these irregularities and register the different data types, we sample the gravity grid at each multibeam point so that each data point record is longitude, latitude, depth, gravity ($xyzg$). We use GMT routine “`grd2xyz`” with the “`-S`” option to convert the multibeam grid to xyz points while suppressing points that have no depth value. We use “`grdtrack`” to interpolate the gravity grid to the multibeam point locations, thus obtaining $xyzg$ for each data point record.

We correct for the inclined sides of the multibeam survey by projecting the $xyzg$ points with an Oblique Mercator projection centered on the multibeam survey and rotating to maximize the rectangular extent of the coverage, via GMT routine “`mapproject`.” The projected and rotated points are shown in Figure 9.2. The projection routine reads positions in longitude and latitude, and outputs positions in meters from the projection center.

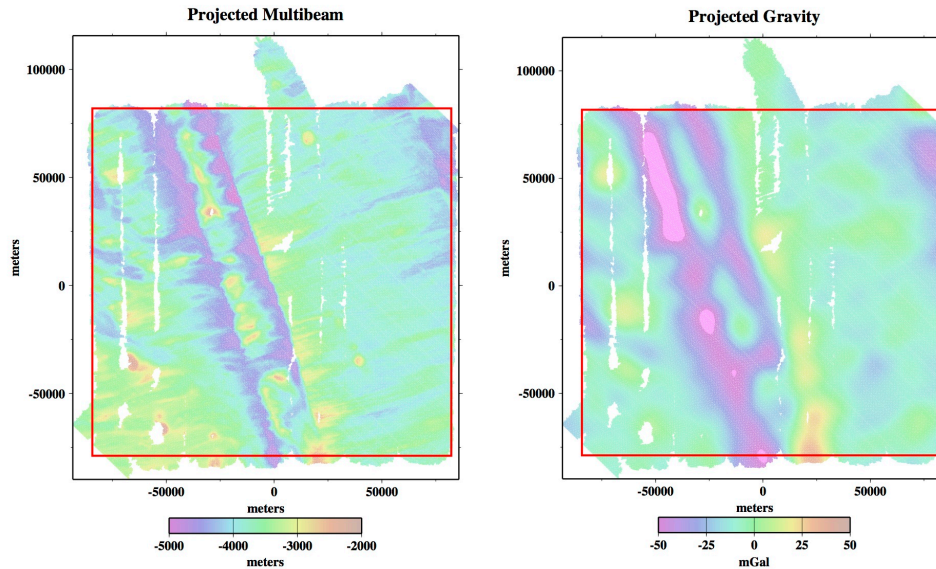

Figure 9.2 Oblique Mercator projected and rotated multibeam (left) and gravity (right) data points. Red box outlines trimming boundary.

The command lines used to project the data points shown in Figure 9.1 into the Oblique Mercator projected locations shown in Figure 9.2 follow. Note that routine “mapproject” is used three times- first, to bring the multibeam points (mb.xyz) into a Mercator projection matching that of the gravity grid (grav.18.1_grd) in order to sample it with “grdtrack;” second, to convert to geographic coordinates; and third, to project the data points into the Oblique Mercator projection including rotation (via the “-Joa” option).

```
gmtset ELLIPSOID Sphere
grd2xyz -S mb_grd > mb.xyz
mapproject mb.xyz -Jm1 -R-172.5/-167.5/-62.0001406129/-59.9969352129 | grdtrack
-Ggrav.18.1_grd | mapproject -l -Jm1 -R-172.5/-167.5/-62.0001406129/-59.9969352129 |
mapproject -C -F -Joa-170/-61/-134/1 -R-172.5/-167.5/-62/-60 > mb.grav.proj.out
```

Example command lines for plotting the multibeam grid shown in Figure 9.1 follow.

```
grdgradient mb_grd -A270 -Nt -Ggrad_grd
grdimage mb_grd -Ctopo.cpt -lgrad_grd -Jm1 -K > Fig.9.1.ps
psbasemap -R-172.5/-167.5/-62/-60 -Jm1 -Ba2f1/a1:."Multibeam Bathymetry":WeSn
-O -K >>Fig.9.1.ps
psscale -D2.5/-.5/2.5/2h -Ctopo.cpt -B1000g1000f1000:meters: -l -N300 -O>>Fig.9.1.ps
```

The command lines for plotting the projected multibeam points shown in Figure 9.2 are below.

```
awk '{print $1,$2,$3}' mb.grav.proj.out | psxy -Ctopo.cpt -Sc.015 -R-93300/85700/-89800/115500
-Jx.000028 -Ba50000f25000:meters:."Projected Multibeam":WeSn -K > Fig.9.2.ps
psscale -D2.5/-.5/2.5/2h -Ctopo.cpt -B1000g1000f1000:meters: -N300 -O>>Fig.9.2.ps
```

There is more preparation needed for coherence analysis. The projected and rotated data points need to be gridded, and the grid needs to be “trimmed” so that almost all grid cells have values, while retaining the largest possible rectangular footprint. GMT routine “surface” is used to grid

the data points- it fills in gaps in the data by interpolation, the “-R” option is used to select the desired area (within the trimming boundary, outlined in red in Figure 9.2), and the output is a grid with a 1 km grid spacing. The “surface” command line follows, and the grids, which are now ready for the coherence operation, are shown in Figure 9.3.

```
surface -R-84240/82120/-78790/81820 -I1000 mb.grav.proj.out -T0.25 -Gmb.surf.1km_grd
```

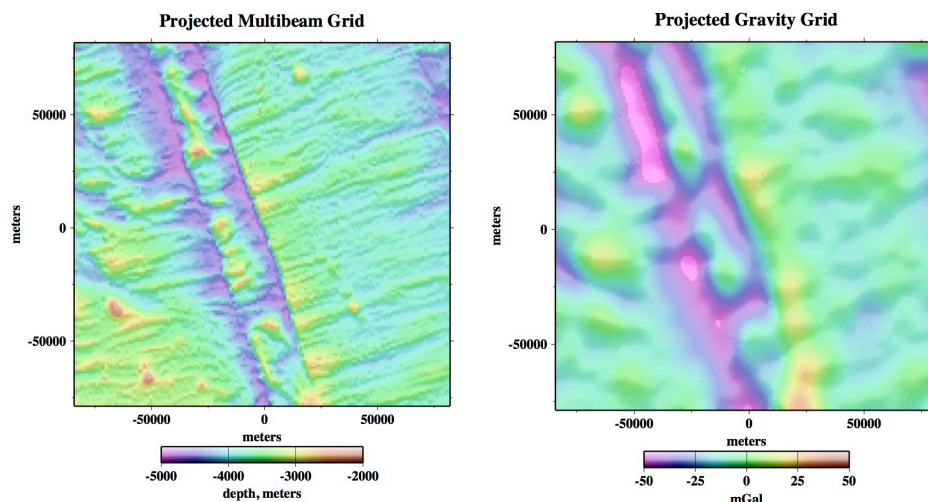

Figure 9.3 Multibeam (left) and gravity (right) grids fully prepared for coherence analysis.

The command lines to plot the multibeam grid shown in Figure 9.3 follow.

```
grdgradient mb.surf.1km_grd -A0 -Ne0.2 -Ggrad_grd
grdimage mb.surf.1km_grd -lgrad_grd -Ctopo.cpt -Jx.000028 -K>Fig.9.3.ps
psbasemap -R-84240/82120/-78790/81820 -Jx.000028 -Ba50000f25000:."Projected Multibeam
Grid":WeSn -O -K>>Fig.9.3.ps
psscale -D2.329/-5/2.5/.2h -Ctopo.cpt -B:"depth, meters": -I -N300 -O >>Fig.9.3.ps
```

9.1.4 Coherence Computation

We use GMT routine “gravfft” to compute the coherence between grids. This routine is a generalization of GMT routine “grdfft” which detrends the grids, tapers the edges, applies a two-dimensional Fast Fourier Transform (FFT), performs the coherence operation, and outputs the coherence averaged azimuthally as a function of wavelength.

The coherence results can be sensitive to the size of the input grid relative to the FFT grid dimensions used by “gravfft” for computation. The routine default selects dimensions that are larger than the input grid file size and that optimize the speed and accuracy of the FFT. Our experience has shown that the most reliable coherence results are obtained when the data grid is square and its dimensions are slightly smaller than the optimal FFT grid dimensions. The FFT dimensions can be specified with the “-N” option. Option “-Ns” prints out a table of suitable FFT dimensions, we list below sizes through 1024.

64, 72, 75, 80, 81, 90, 96, 100, 108, 120, 125, 128, 135, 144, 150, 160, 162, 180, 192, 200, 216, 225, 240, 243, 250, 256, 270, 288, 300, 320, 324, 360, 375, 384, 400, 405, 432, 450, 480, 486, 500, 512, 540, 576, 600, 625, 640, 648, 675, 720, 729, 750, 768, 800, 810, 864, 900, 960, 972, 1000, 1024

The command line for computing coherence with “gravfft” follows. Two grids are input- multibeam and gravity grids- and both have been prepared as described above. The output columns are wavelength in meters, coherence, and one sigma error.

```
gravfft mb.surf.1km_grd -lgrav.surf.1km_grd/wc > coh.out
```

Coherence for the Pacific-Antarctic spreading ridge study area is shown in Figure 9.4.

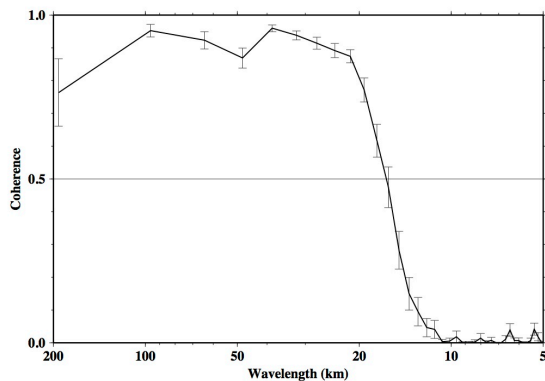

Figure 9.4 Radial coherence (black line) between grids shown in Figure 9.3. One sigma error bars are plotted.

For this area, bathymetry and gravity are coherent down to ~16 km.

The command lines used to plot Figure 9.4 follow.

```
awk '{print $1/1000.,$2}' coh.out | psxy -R5/200/0/1 -JX-6/4 -W4  
-Ba2f3:"Wavelength (km)":/a.5f.1g.5:"Coherence":WeSn -W4 -K > Fig.9.4.ps  
awk '{print $1/1000.,$2,$3}' coh.out | psxy -Ey -R -JX -W4 -O >> Fig.9.4.ps
```

9.1.5 Interpreting Coherence Results

Figure 9.4 shows that gravity and bathymetry anomalies in this study area are coherent in the intermediate wavelength band. Coherence appears to decrease at wavelengths greater than ~100 km because longer wavelength topography is Airy compensated and the gravity signal is cancelled out. At shorter wavelengths, the coherence is low due to upward continuation of gravity from the seafloor to the sea surface. The gravity anomalies in Figure 9.1 (and Figure 9.3) look like a smoothed version of the multibeam bathymetry anomalies because of the upward continuation.

REFERENCES

Bendat JS Piersol AG (1986) Random data: Analysis and measurement procedures, 2nd edn., Wiley, New York

Sandwell DT, Smith, WHF (1997) Marine gravity anomaly from Geosat and ERS 1 satellite altimetry, J Geophys Res 102:10039-10054, doi:10.1029/96JB03223

ADVANCED TOPICS

Chapter 10.0 Uncertainty

10.1 Sources of Uncertainty

The following has been extracted from 5th Edition, S-44 (2008) Annex A, section A.4 by Rob Hare and editing for context

Although the following text focuses on uncertainties in data acquired with swath systems, it should be noted that it is in principle applicable to data acquired with any depth measurement system. A single-beam echosounder is just a special case of a multibeam echosounder (i.e. nadir beam only)

With swath systems the distance between the sounding on the seafloor and the positioning system antenna can be very large, especially in deep water. Because of this, sounding position *uncertainty* is a function of the errors in vessel heading, beam angle, refraction correction model and the water depth in addition to the uncertainty of the positioning system itself.

Roll and pitch errors will also contribute to the uncertainty in the positions of soundings. Overall, it may be very difficult to determine the position *uncertainty* for each sounding as a function of depth. The uncertainties are a function not only of the swath system but also of the location of, offsets to and accuracies of the auxiliary sensors.

The use of non-vertical beams introduces additional uncertainties caused by incorrect knowledge of the ship's orientation at the time of transmission and reception of sonar echoes. Uncertainties associated with the development of the position of an individual beam should include the following:

- a) Positioning system uncertainty;
- b) Range and beam angle uncertainty;
- c) The uncertainty associated with the ray path model (including the sound speed profile), and the beam pointing angle;
- d) The uncertainty in vessel heading;
- e) System pointing uncertainty resulting from transducer misalignment;
- f) Sensor location;
- g) Vessel motion sensor errors i.e. roll and pitch;
- h) Sensor position offset uncertainty; and
- i) Time synchronization / latency.

Contributing factors to the vertical *uncertainty* include:

- a) Vertical datum uncertainty;
- b) Vertical positioning system uncertainty (if relevant);
- c) Tidal measurement or prediction uncertainty, including co-tidal uncertainty where appropriate;
- d) Range and beam angle uncertainty;

-
- e) The uncertainty associated with the ray path model (including the sound speed profile), and the beam pointing angle;
 - f) Ellipsoidal / vertical datum separation model uncertainty (if relevant);
 - g) Vessel motion uncertainty, i.e. roll, pitch and heave;
 - h) Vessel dynamic draught, including static draft, settlement and squat;
 - i) Seabed slope (when combined with positioning uncertainty); and
 - j) Time synchronization / latency.

Agencies responsible for the survey quality are encouraged to provide uncertainty budgets for their own systems.

10.2 Measuring uncertainty

10.2.1 Methods of quality assessment, artifacts

TEXT IN PREPARATION

10.2.2 Comparisons with multibeam

	TEXT IN PREPARATION
Local	TEXT IN PREPARATION
Regional	TEXT IN PREPARATION
Global	TEXT IN PREPARATION

10.2.3 Monte Carlo Technique

Contributed by Paul Elmore, Naval Research Laboratory, Stennis Space Center, USA

A peer-reviewed methodology for estimating error on historic data sets using a Monte Carlo technique is published in Jakobsson et al. (Jakobsson et al. 2002); Figure 10.1 illustrates the procedure. It can be used on either historic or new soundings to provide an error layer for the GMT Splines-In-Tension routine (Surface routine). In order for this technique to work, estimates of the horizontal and vertical uncertainties for the soundings are needed.

In the simulations, the original two-dimensional navigation positions and the one-dimensional soundings are randomly perturbed using a normally distributed random number generator (RNG). Let the number of original soundings be J , the number of surveys be K , the horizontal navigation uncertainty of the K^{th} survey be H_K , the vertical sonar uncertainty of the K^{th} survey be V_K , the number of output grid points be I , and the number of Monte Carlo simulations be N , with each loop denoted by n . For the K^{th} survey, the RNG perturbs the position data $\sim \mathcal{N}(0, H_K^2)^\dagger$ and the vertical position $\sim \mathcal{N}(0, V_K^2)$. The gridded bathymetry surface is constructed from the GMT Surface (or other interpolator of choice) during each loop of the Monte Carlo simulation, resulting in N different interpolated bathymetry surfaces. The gridded uncertainty estimate is then the standard deviation of the N surfaces at each i^{th} grid point, $i \in I$. Assuming that all sounding used have been cleaned and corrected for ship dynamics, sound speed profile errors, etc., positional uncertainty and the bottom slope predominantly influence the bathymetric uncertainty estimated from this method.

A benefit of this method is that it is relatively simple to code: one simply needs the interpolation and RNG routines called within a Monte Carlo shell that perturbs the horizontal and vertical positions. This procedure, however, is computationally intensive and requires the use of original soundings data. Attempting this approach for a large number of soundings data may not be pragmatic.

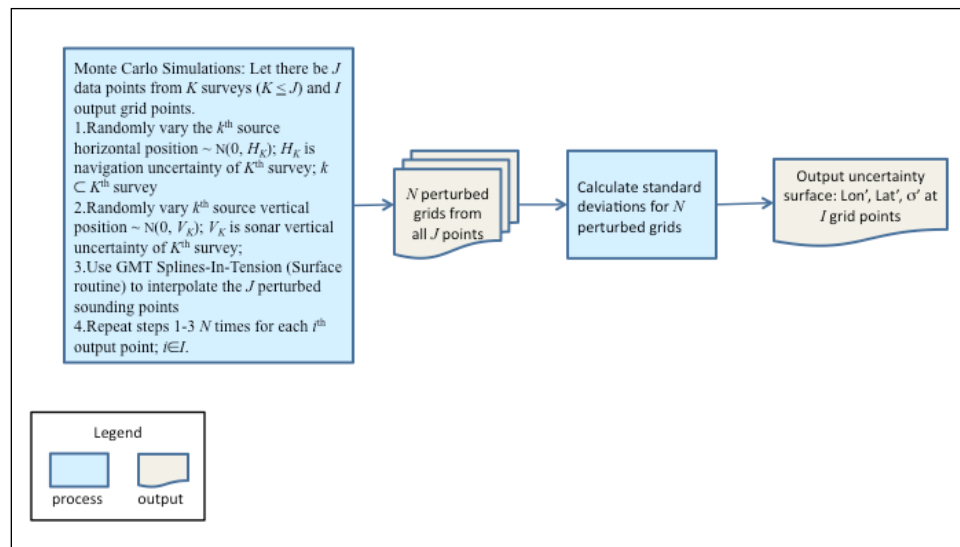

Figure 10.1 Process flow for the Monte Carlo procedure of Jakobsson et al (2003).

10.2.4 Bayesian Network Technique

Contributed by Paul Elmore, Naval Research Laboratory, Stennis Space Center

[†] The notation $\sim \mathcal{N}(\mu, \sigma^2)$ means that the quantity follows a normal, or Gaussian, probability distribution with mean μ and variance σ^2

When the data sets are large, a Bayesian network (BN; a good discussion is given in Chapter 14 of Russell and Norvig (2003)) can be an alternative to the Monte Carlo method. With this approach, published in Elmore et al. (2009) and illustrated in Figure 10.2, causal relationships of navigation error and bottom slope to bathymetric uncertainty are quantified by conditional probability densities (CPD's). One uses the Monte Carlo technique on representative sets of soundings data to tabulate the CPD's necessary for the statistical inference. The BN then produces a histogram of this uncertainty estimate for an area given the navigation errors used to survey the region and bottoms slopes that are present. An intermediate uncertainty is obtained from the mean plus one standard deviation of the histogram. The final uncertainty estimate is obtained by first adding the square of this intermediate uncertainty to the square of the vertical error estimate under the assumption of statistical independence between the two, then computing the square root of this sum. This type of computation is much less costly than the Monte Carlo technique both in computation overhead and required input data, potentially leading to a significantly large (two orders of magnitude) increase in computational speed. Estimates of the horizontal and vertical uncertainty for the soundings must be available to both train the network and run the Bayesian Network.

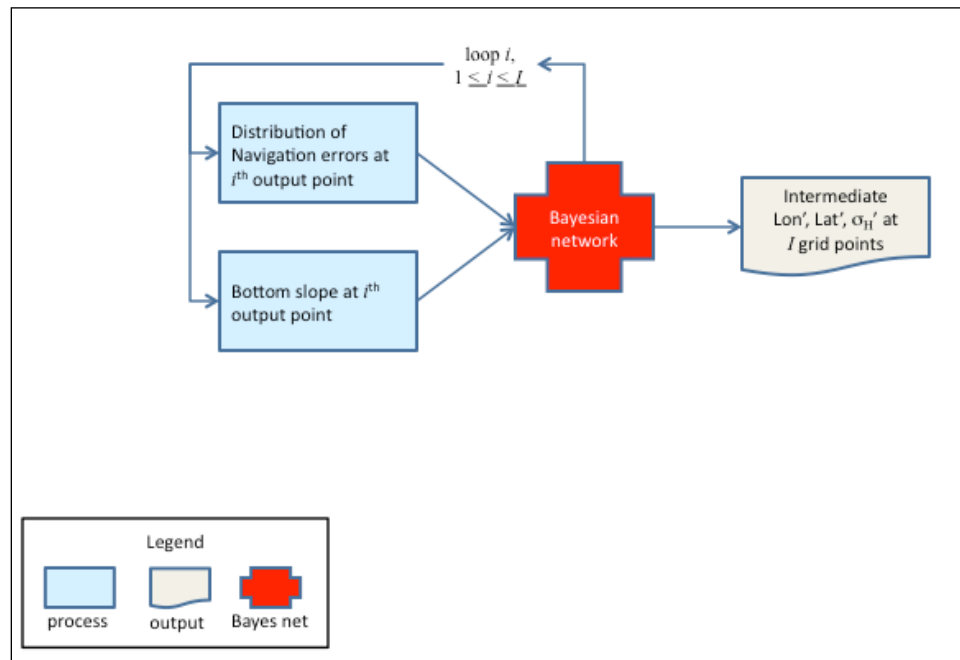

Figure 10.2 Conceptual flow of the Bayesian Network approach.

Bayesian Network Design and Access

The Bayesian network itself can be programmed using commercial Netica software, Version 4.0.8 (2008), which provides a GUI for construction and programming of the BN and (as of this writing) is free to use for the small Bayesian network created here. Figure 10.3 shows the network topology as displayed by the Netica GUI from Elmore et al (2009). It consists simply of two main parent nodes, one for navigation error and one bottom slope, and one child node, the

intermediate uncertainty estimate. In this example, there are eight different surface navigation uncertainties categories; Table 10.1 associates historical navigation techniques to uncertainty. The bottom slope and bathymetric uncertainties follow a logarithmic binning scheme so that one significant digit is maintained in the uncertainty estimate while keeping the BN to a manageable size. Once created, the software stores the BN as either a binary object or ASCII file that can be accessed and manipulated through the use of vendor provided application program interface (API) libraries.

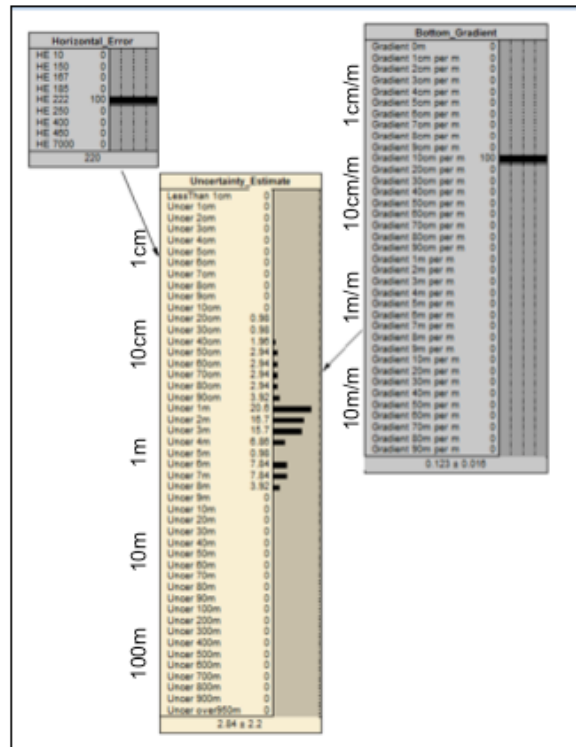

Figure 10.3 Bayesian network topology as displayed by the Netica software GUI. The “Horizontal_Error” node variables follow the navigation errors provided in Table 1, with the numbers for surface navigation error in meters. The “Bottom_Gradient” and “Uncertainty_Estimate” nodes follow a logarithmic binning scheme.

Table I: Horizontal Error Categories

Navigation Mode	Accuracy	Navigation Mode	Accuracy
GPS/SINS (3 or more Satellites)	10-15 m	NAVSAT/Single Range LORAN/SINS	250 m
GPS/DR (3 or more Satellites)	10-15 m	NAVSAT/ SINS	250 m
NAVSAT/Range Range LORAN/SINS	150 m	NAVSAT/Single Range LORAN/DR	250 m
NAVSAT/Range Range LORAN/DR	167 m	NAVSAT/DR	400 m
NAVSAT/Hyperbolic LORAN/SINS	185 m	LORAN/SINS LORAN/DR	463 m
NAVSAT/Hyperbolic LORAN/DR	222 m	Satellite Altimetry	7000 m

Table 10.1 Navigation uncertainty categories used in Elmore et al. (2009) for the Bayesian Network approach to uncertainty estimation. The abbreviations are as follows: GPS – Global Positioning System; SINS – Ship’s Inertial Navigation System; DR – Dead Reckoning; NAVSAT – Navy Navigation Satellite System; LORAN – Long Range Navigation. The “/” means that two or more techniques are combined.

Bayesian Network Training Procedures

Using the procedure from Jakobsson et al. (2003), one ascertains the propagation of navigational error and bottom slope into bathymetric uncertainty by Monte Carlo simulations. Let there be a total on M navigation error categories. The results of the simulations (a total of $M \times N$ simulations) to populate the CPT of the BN, or “train” the BN. Figure 10.4 shows a high level view of the entire training process, bracketed into three main blocks: 1) Monte Carlo simulations, 2) standard deviation and slope calculations, and 3) Bayes network programming.

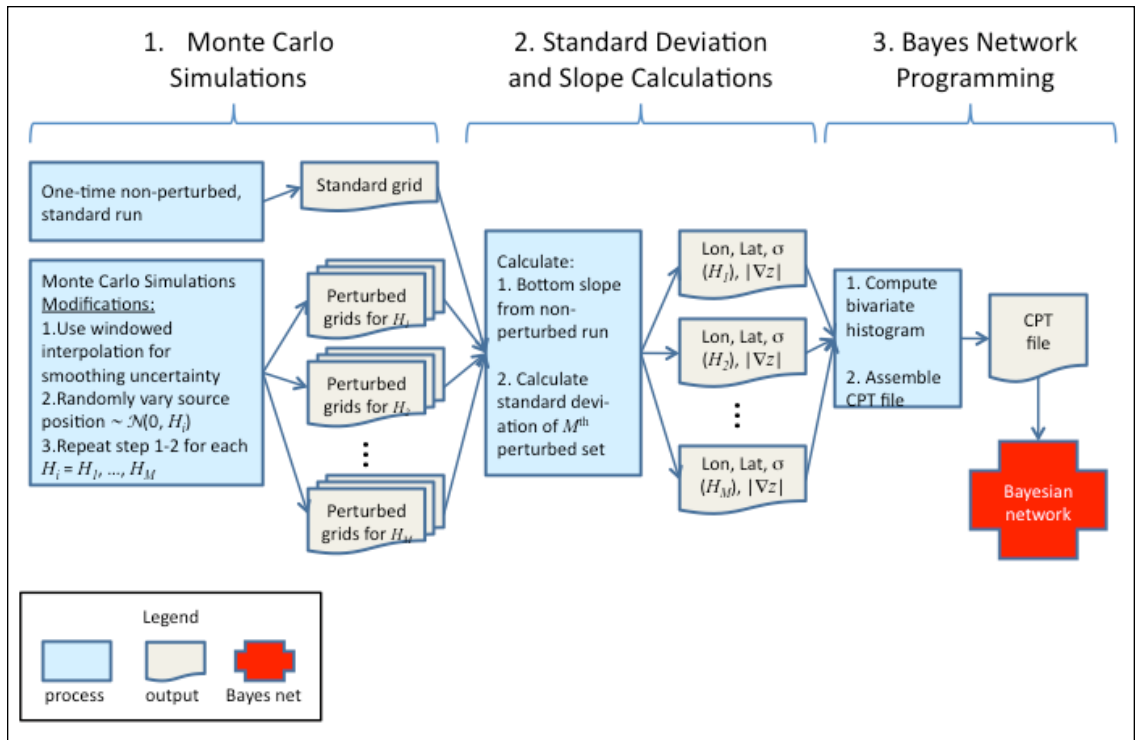

Figure 10.4 High level view of the Bayesian network training process. The figure illustrates computation of the standard deviations as modified from Jakobsson (2003), and use of these results to construct the conditional probability tables (CPT) for the Bayesian network.

Figure 10.5 shows a low level flow chart for the Monte Carlo block. In the Monte Carlo simulations, the original locations of the sounding points (or gridded points acting as sounding points) are first moved in random directions. A normal RNG (Marsaglia and Tsang 2000) provides deviations for the north and east positions as specified by the horizontal error category for the m^{th} simulation loop, H_m ($1 \leq m \leq M$), such that the $\text{RNG} \sim \mathcal{N}(0, H_m^2)$. The data points are then interpolated to provide a bathymetry surface and stored to an ASCII text file, with the Monte Carlo loop number and navigation error stored in the file name. As in Jakobsson et al. (2003), $N = 100$ Monte Carlo iterations may be performed for each m^{th} set of simulations; however, a difference between the two is that the set of N Monte Carlo simulations are then repeated M times for each horizontal error category in order to fully populate the CPT of the BN. Another difference from the Monte Carlo procedure is that each sounding is assumed to have the same probability distribution of horizontal errors so that one can obtain a statistical distribution for bathymetric uncertainty for a range of horizontal errors. Although the actual data do not necessarily have these errors, it is assumed they do in order to train the network. Also, the vertical positional will be treated algebraically as discussed in Section 3 below.

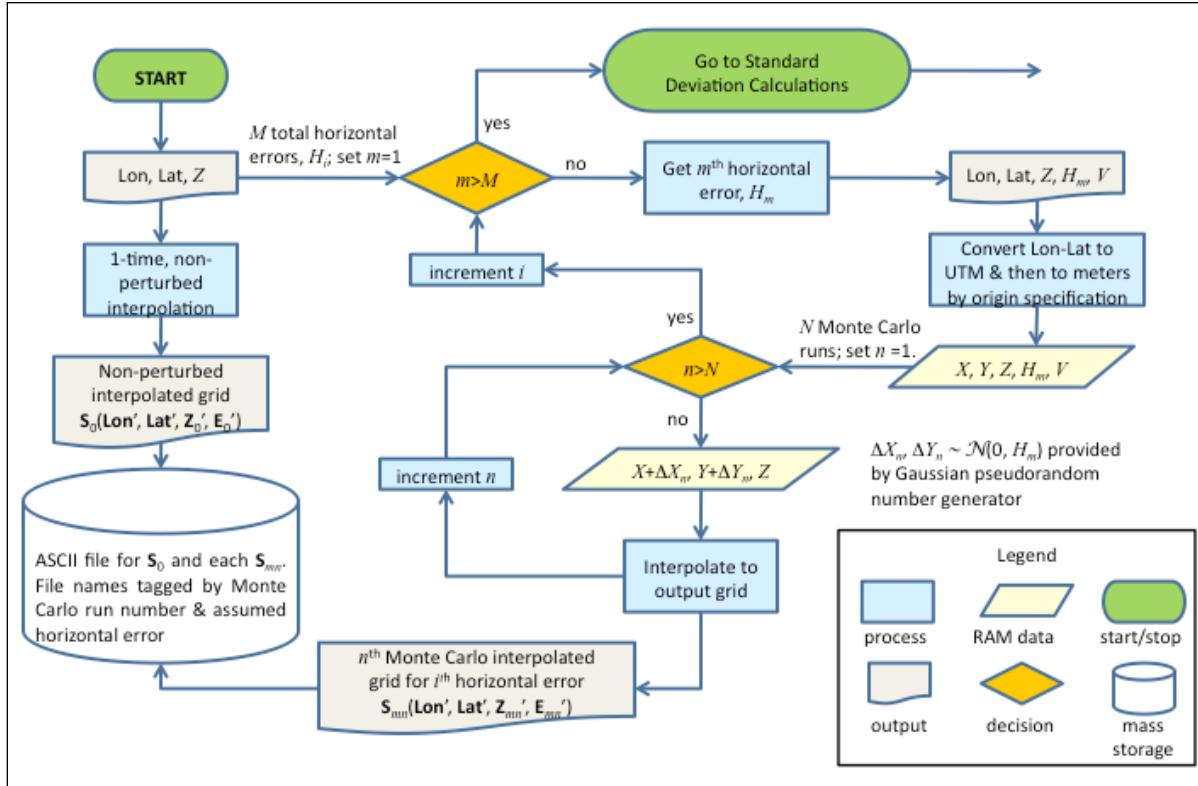

Figure 10.5 Low level flow chart of the Monte Carlo simulations block for the Bayesian network training process. Here, X and Y are the east and north positions of the output grid points in meters after conversion to Universal Transverse Mercator (UTM) projection and specification of a UTM origin in the grid, Z is interpolated depth, S_0 is an unperturbed interpolation, S_{mn} is the perturbed grid for the n^{th} Monte Carlo loop and m^{th} Horizontal Error Category, E' is error from smoothing. The bold face means that the quantity is a vector.

Figure 10.6 shows a low level flow chart for the next block of the training process, the standard deviation and slope calculations block. After completion of the final iteration, the uncertainty estimate for the set of I output points are computed from the gridded standard deviation of the Monte Carlo bathymetry surfaces and stored to ASCII files for use below (low level flow chart shown in Fig. 10.7). Specifically, the ASCII files contain longitude, latitude, bathymetry, Monte Carlo standard deviation and magnitude of the two-dimensional slope. To obtain the slopes, an unperturbed calculation of the bathymetry surface is first made, followed by computation of the bottom gradient throughout the grid. One can use finite differences as discussed in Zhou and Liu (2004) and Oksanen and Sarjakoski (2005) to calculate bottom gradient. Longitude and latitude positions are translated to UTM coordinates so that positional differences and gradients can be computed in meters. Linear extrapolation is used to aid computation of the gradient along the computational edges.

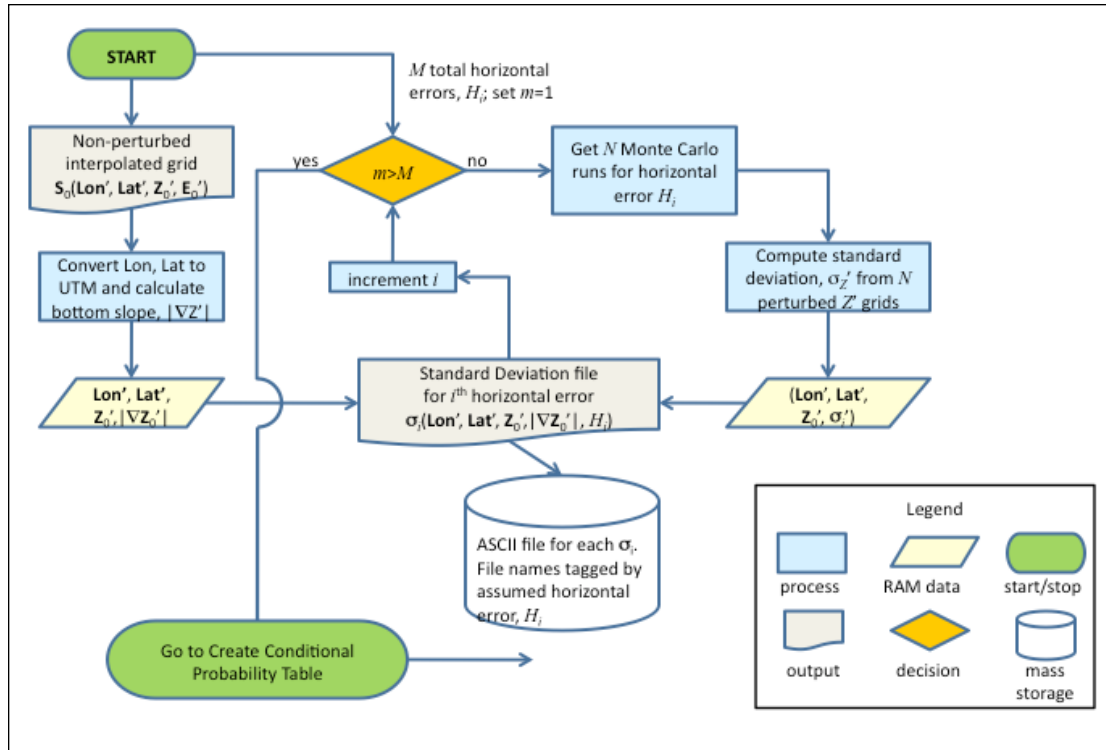

Figure 10.6 Low level flow chart of the Standard Deviations block for the Bayes net training process.

Figure 10.7 shows a low level flow chart for the final block of the training process, the Bayes network programming block. The BN is programmed using the graphic user interface (GUI) in Netica on a Windows based PC. The ASCII files containing the Monte Carlo uncertainties and bathymetric slopes are first read from the standard deviation file discussed in the above section for the first navigation uncertainty category. Then, using the logarithmic binning scheme discussed above we compute the bivariate histogram (i.e., three-dimensional histogram) with slopes and bathymetry uncertainty, respectively, indexing the row and column bins of the bivariate histogram. This histogram is normalized and written to an ASCII file. This process is then repeated for subsequent navigation uncertainties with the resultant normalized bivariate histograms appended to the same output file.

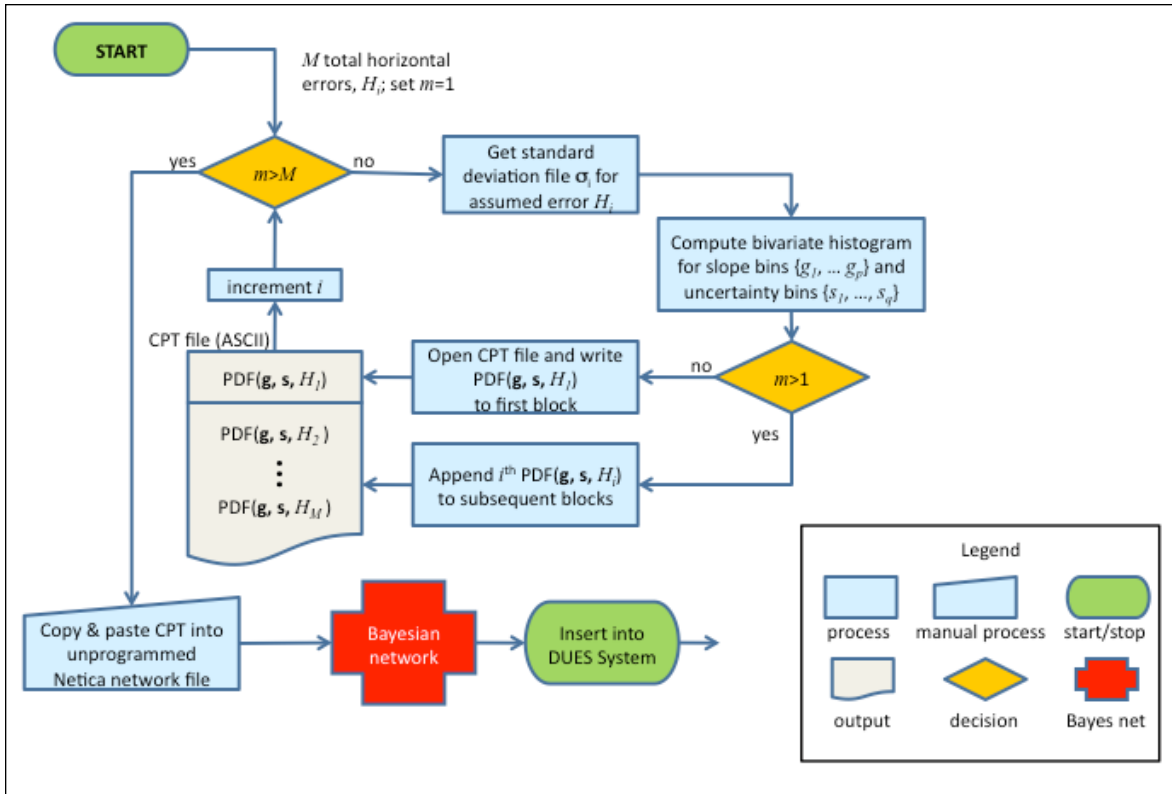

Figure 10.7 Low level flow chart of the Bayes network programming block for the Bayesian network training process. The network is stored in a library file that is accessed by API.

After completing this process, the Bayesian network *.neta file is opened in the Netica GUI, and the CPT for the “Uncertainty Estimate” node is displayed. The CPT is programmed by simple “copy-and-paste” from the ASCII file into the spreadsheet-like data display for the CPT in the GUI. The CPT is already arranged to have the same stacked structure as the ASCII file.

Operational Flow

Figure 10.8 shows how the BN could be integrated into the overall operational system, with key components and data flow. The end user of the system first defines a region of interest for uncertainty estimation, followed by query of available navigation and bathymetry for the area. The navigation metadata would indicate survey era and platform used from the navigation data to obtain the types of navigation (for horizontal uncertainty) and sonar systems (for vertical uncertainty) used for the track lines in the area. The fractional lengths of track lines with like uncertainties could be calculated (i.e. sum of all track lengths with a like error divided by the total of all track lengths) and become the weights for the BN’s Horizontal Error node. Also extracted is the bathymetry from the same area to obtain the bottom gradient. The system loops through each grid point, assigns the bottom gradient to the appropriate bin of the BN’s Bottom Gradient node, and extracts the resultant histogram. Calculation of mean plus one standard deviation for this histogram provides the intermediate uncertainty. The final uncertainty estimate

is obtained by first adding the square of the intermediate uncertainty to the square of the vertical uncertainty estimate.

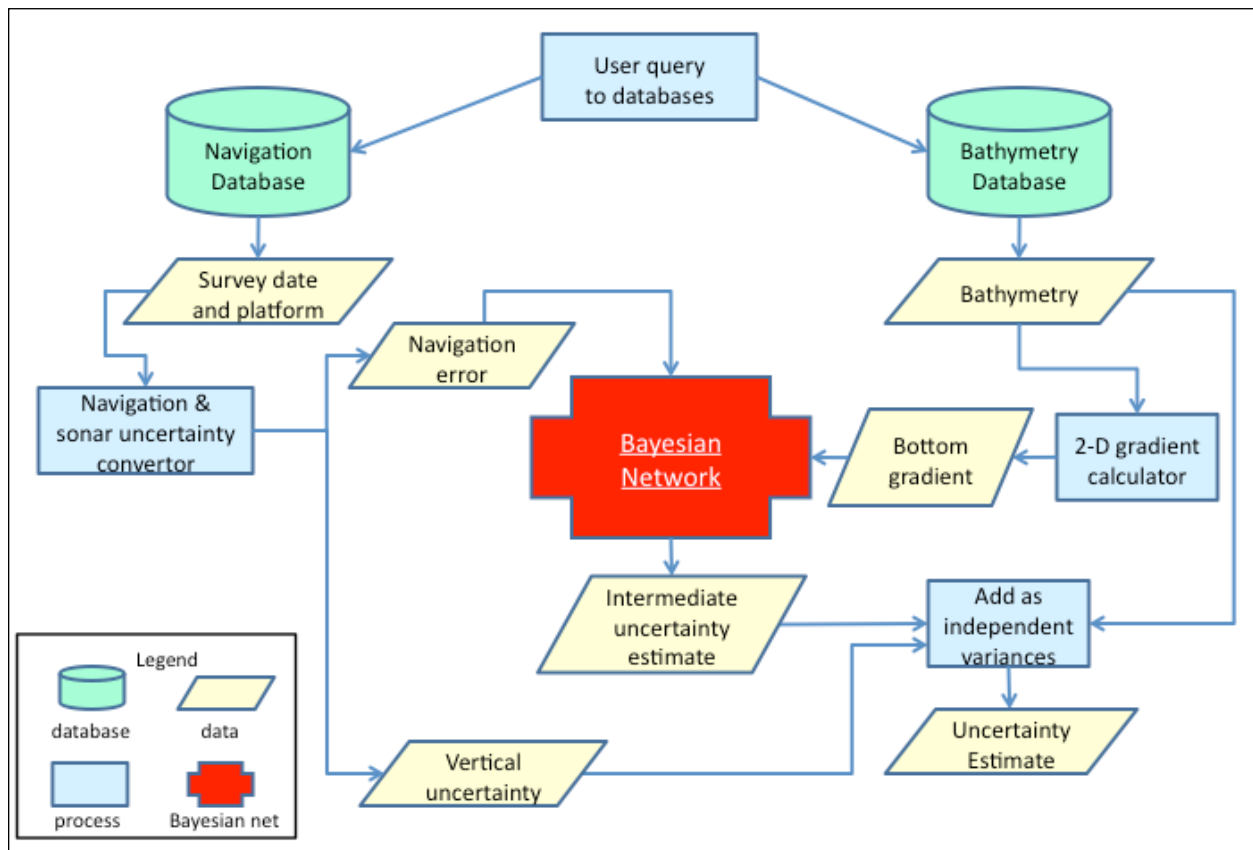

Figure 10.8 Integrated flow chart of the DBDB-V Uncertainty Expert System (DUES) after programming of the Bayes network component is complete.

10.2.5 Windowed Regression with Kriging Corrections

Contributed by Paul Elmore, Naval Research Laboratory, Stennis Space Center

As an alternative to using GMT surface, localized regression techniques of Cleveland (1979) have been applied to bathymetry problems in Plant et al. (2002). This technique was then refined by Calder (2006) to provide refinements to the interpolated surface and uncertainty estimate using ordinary kriging and the Monte Carlo technique discussed in Section A above. An advantage of this technique is that it provides an uncertainty estimate with the interpolated surface. A disadvantage is that it requires dense data sounding to be meaningful. The discussion that follows below closely to the discussions in the papers by Cleveland (1979) and Calder (2006).

Linear Smoothing by Locally Weighted Regression (Loess)

Linear smoothing techniques construct the interpolated surface, $\hat{z}(\mathbf{s})$, $\mathbf{s} \equiv$ matrix of (x, y) coordinates, from a linear weighted average of known data values. Unlike the splines-in-tension technique that finds a global solution to the available data, this technique obtains an interpolated value at a grid point by using only a subset of neighboring points. Mathematically,

$$\hat{z}(\mathbf{s}) = \sum_i \alpha(\mathbf{s} - \mathbf{s}_i) z(\mathbf{s}_i), \quad ((i))$$

where $\alpha(\mathbf{s} - \mathbf{s}_i)$ specifies the smoother coefficients and the index i corresponds to the subset of local points, $z(\mathbf{s}_i)$, to be used for the interpolated value at \mathbf{s} , $\hat{z}(\mathbf{s})$. A common technique used to specify these coefficients is locally weighted regression (or “loess”), first published in Cleveland (1979) and further developed in Cleveland and Devlin (1988). A textbook by Givens and Hoeting (2005) also discusses the technique. The methodology determines the smoother coefficients from a weighted least squares polynomial (linear or quadratic) fit of windowed data.

1. Methodology

To summarize Cleveland’s methodology, the two-dimensional case is considered first. These equations to the three-dimensional case in Section B, but the methodology will remain the same. Let data points x_i and y_i be related as

$$y_i = g(x_i) + \varepsilon_i, \quad ((ii))$$

where $g(x)$ is a smooth function and ε_i is Gaussian noise with zero mean and variance σ^2 . Define \hat{y}_i to be the estimate of $g(x_i)$ (i.e. $\hat{y}_i \approx g(x_i)$). Let

- the number n be the predetermined number of data points to be used for estimating \hat{y}_i
- the set $x_k, k = 1, \dots, n$, be the subset of x_j ’s ($j = 1, \dots, N; N =$ total number of data points, $n < N$) that are closest to x_i
- the distance h_i be the distance from x_i to the furthest x_k .
- the windowing weights to be used for the regression, $w_k(x_i) = W([x_k - x_i]/h_i)$, where $W(x)$ is the tricube function, defined as

$$W(x) \equiv \begin{cases} (1 - |x|^3)^3, & x < 1 \\ 0, & \text{otherwise} \end{cases} \quad ((iii))$$

With these definitions, the loess procedure calculates the set of polynomial coefficients, $\hat{\beta}_i(x_i)$, that are the values for the β_i ’s that minimize

$$q(x_i) = \sum_{k=1}^n w_k(x_i) (y_k - \beta_0 - \beta_1 x_k - \dots - \beta_d x_k^d)^2, \quad ((iv))$$

where $q(x_i)$ is the error function. The interpolated value for $g(x_i)$ is then

$$\hat{y}_i = \sum_{l=0}^d \hat{\beta}_l(x_i) x_i^l = \sum_{k=1}^n \alpha_k(x_i) y_k. \quad ((v))$$

Some points of interest are as follows (Cleveland 1979).

- The coefficients obtained have a decreasing trend to the edge of the window so that the data centered in the window generally have the greatest influence.
- The size of the polynomial typically used in Eqn. ((iv)) is $d = 1$ or 2 . For $d = 0$, the result is a simple moving average. The $d = 1$ case is called linear loess or “lowess” smoothing, and $d = 2$ is quadratic “loess” smoothing.
- Cubic and higher fits typically are not used as the fits can become over fitted and numerically unstable.
- This technique also has a robustness option, so that the interpolation can be shielded from the effects of outliers in the data.
- Cleveland choose the tricube weighting function because it allowed the estimate of the error variance to be approximated by a chi-square distribution and usually lowered the variance of the estimate surface as the number of points used for the estimate increased.

Errors propagated into the interpolation by the technique are straight forward to compute. Under the assumption the data follow Eqn. ((ii)), the estimate of the variance for \hat{y}_i , $\hat{\sigma}_i^2$, is (Plant et al. 2002)

$$\hat{\sigma}_i^2 = \sigma^2 \sum_{k=1}^n [\alpha_k(x_i)]^2, \quad ((vi))$$

which is derivable from independent error propagation.

2. Convolution Approach

Figure 10.9 plots the set of α_k 's as determined for a centered impulse response using the linear and quadratic loess interpolators. These coefficients are the smoother weights in Eqn. ((v)) and are also called the “equivalent kernel”. They depend only on the grid points, and, due to their finite width, act as a window or low-pass filter function on the spatial data (i.e. the smoothing weights and the data undergo convolution). Hence, one could bypass solving a weighted least square problem and simply compute the convolution of the smoothing window with the data, which should be computationally faster. In addition, other windowing functions could be used to perform the smoothing.

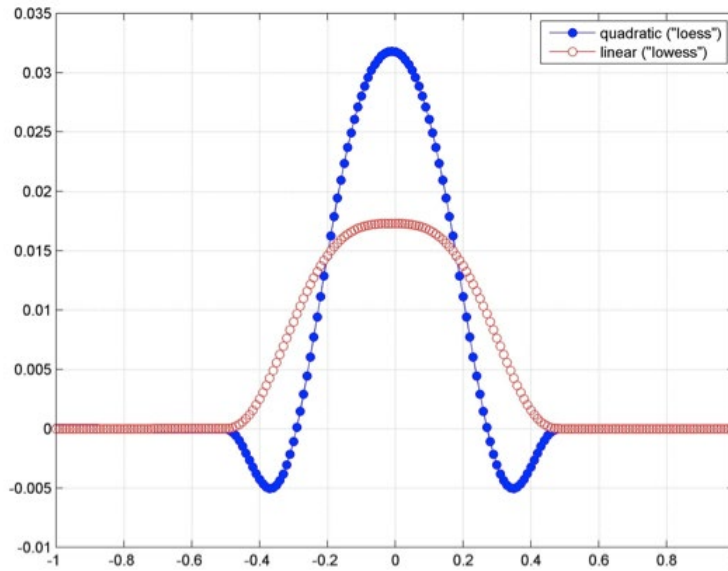

Figure 10.9 Equivalent kernel weights for linear and quadratic loess windows.

The use of other weighting functions would also allow one to interpolate over data points with differing accuracy. In this case, Eqns. ((v) and ((vi) become

$$\hat{y}_i = \sum_{k=1}^n \alpha_k(x_i) \left(\sigma_k^{-2} / \sum_{k=1}^n \sigma_k^{-2} \right) y_k = \sum_{k=1}^n \tilde{\alpha}_k(x_i) y_k, \quad ((vii)$$

$$\hat{\sigma}_i^2 = \sum_{k=1}^n \sigma_k^2 \tilde{\alpha}_k^2(x_i) \quad ((viii)$$

where σ_k^2 is the variance of y_k and $\tilde{\alpha}_k(x_i) \equiv \alpha_k(x_i) \left(\sigma_k^{-2} / \sum_{k=1}^n \sigma_k^{-2} \right)$.

Combining windowing with ordinary kriging corrections

Since the above regression technique smooths the data, Calder (2006) provides an ordinary kriging step for correcting at the sounding points with the Monte Carlo technique to accounts for navigation uncertainty. The summary of the complete methodology is as follows.

1. Following Plant et al. (2002), interpolate the data with the quadratic loess interpolation technique of Cleveland (1979) to provide a trend surface for the bathymetry and uncertainty layer.
2. Restore finer details smoothed by the interpolation from ordinary kriging of the residuals; add the errors associated with ordinary kriging to the uncertainty layer from Step 1

assuming statistical independence (i.e. the variances add). The surface generated from kriging the residuals is the residual surface.

3. Estimate additional uncertainty caused by positional errors from the Monte Carlo technique of Jakobsson et al. (2002), but repeat steps 1 and 2 above instead of using the splines-in-tension algorithm at each iteration. As before, add the estimated error to the uncertainty layer by assuming statistical independence.

In equation form, the final bathymetry surface, $Z(\mathbf{s})$, is the sum of the trend surface, $\mu(\mathbf{s})$, and the residual surface, $R(\mathbf{s})$.

$$Z(\mathbf{s}) = \mu(\mathbf{s}) + R(\mathbf{s}) \quad ((ix))$$

The uncertainty layer, $\sigma_Z(\mathbf{s})$, is

$$\sigma_Z(\mathbf{s}) = [\sigma_\mu^2(\mathbf{s}) + \sigma_R^2(\mathbf{s}) + \varepsilon^2(\mathbf{s})]^{1/2}, \quad ((x))$$

where $\sigma_\mu(\mathbf{s})$ and $\sigma_R(\mathbf{s})$ are the uncertainties for the trend and residual layers, respectively, and $\varepsilon(\mathbf{s})$ is the uncertainty layer associated with positional errors.

1. Quadratic Loess Interpolation for Trend Surface

Extending Eqn. ((iii) through ((vi) to two dimensions, the equations for calculating the trend surface, $\mu(\mathbf{s})$ in Eqn. ((ix) are as follows.

$$\mu(\mathbf{s}) = \mathbf{p}^T(\mathbf{s})\hat{\boldsymbol{\beta}}(\mathbf{s}), \quad ((xi))$$

where $\mathbf{p}^T(\mathbf{s}) \equiv [x^2, y^2, xy, x, y, 1]$ and vector $\hat{\boldsymbol{\beta}}(\mathbf{s}) \equiv [\hat{\beta}_5(\mathbf{s}), \hat{\beta}_4(\mathbf{s}), \hat{\beta}_3(\mathbf{s}), \hat{\beta}_2(\mathbf{s}), \hat{\beta}_1(\mathbf{s}), \hat{\beta}_0(\mathbf{s})]^T$ being the set of $\beta_n(\mathbf{s})$'s that minimize the weighted least squares

$$q(\mathbf{s}) = \sum_{k=1}^n w_k(\mathbf{s}) (z_k - \beta_0(\mathbf{s}) - \beta_1(\mathbf{s})y_k - \beta_2(\mathbf{s})x_k - \beta_3(\mathbf{s})x_k y_k - \beta_4(\mathbf{s})y_k^2 - \beta_5(\mathbf{s})x_k^2)^2 \quad ((xii))$$

using the two-dimensional tri-cube weighting function

$$w_k(\mathbf{s}) = \begin{cases} \left(1 - \left|\frac{\mathbf{s} - \mathbf{s}_k}{d_0}\right|^3\right)^3, & \left|\frac{\mathbf{s} - \mathbf{s}_k}{d_0}\right| < 1 \\ 0, & \text{otherwise} \end{cases}, \quad ((xiii))$$

and the user provided value for d_0 , which Calder's paper suggests that d_0 be ten times the largest sample spacing. Information lost by oversmoothing is regained when the residuals are calculated in the kriging portion.

Estimates for the variances follow Eqn. ((vi) for like variances in all the data or $\hat{\sigma}^2(\mathbf{s}) = \sum_{k=1}^n [\alpha_k(\mathbf{s})\sigma_k]^2$ for differing variances. The $\alpha_k(\mathbf{s})$'s now have azimuthal symmetry and the same radial dependence as the 1-D case.

In addition, the estimate is made more robust (i.e. eliminate outliers) by flagging estimates greater than three Mahalanobis units as “no data”. The Mahalanobis distance (Mahalanobis 1936), $\mathbf{M}(\boldsymbol{\mu}, \mathbf{m}, \mathbf{C})$, is

$$\mathbf{M}(\boldsymbol{\mu}, \mathbf{m}, \mathbf{C}) \equiv (\boldsymbol{\mu} - \mathbf{m})^T \mathbf{C}^{-1} (\boldsymbol{\mu} - \mathbf{m}) \quad ((xiv)$$

where $\boldsymbol{\mu}(\mathbf{s})$ is the vector of all estimated depths and $\mathbf{m}(\mathbf{s})$ and $\mathbf{C}(\mathbf{s})$ are the corresponding mean depth measurements and covariances for the windowed (c.f. Eqn. ((xiii)) data sets. To intuitively explain Eqn. ((xiv), suppose that the data points are all independent and have mean m and variance σ^2 . The \mathbf{C} matrix is all zeros except for the diagonal elements, which are all σ^2 . Then, if an estimate differs from its corresponding windowed mean by more than three variances (i.e. $(\mu - m)^2 / \sigma^2 > 3$), that estimate receives the “no data” mark. Eqn. ((xiv) generalizes this simpler scenario to account for covariance between the data.

2. Kriging the Residuals

Since loess interpolation is not exact at the data points, residuals, $R(\mathbf{s}_i)$, exists between actual measurements, $z(\mathbf{s}_i)$, and the corresponding estimated depths along trend surface, $\mu(\mathbf{s}_i)$, such that $R(\mathbf{s}_i) = z(\mathbf{s}_i) - \mu(\mathbf{s}_i)$. The residual surface in Eqn. ((ix) is found from interpolation of the $R(\mathbf{s}_i)$ set using ordinary kriging, as an overall but constant unknown bias may exist in the residuals. The variogram will likely have directional anisotropy, so that $2\gamma(\mathbf{s}_i, \mathbf{s}_j) = 2\gamma(h, \theta)$, where h is the separation distance between the two points and θ is the heading angle (clockwise from the north).

To account for this anisotropy, the following semivariance, $\gamma_D(\mathbf{s}_i, \mathbf{s}_j)$, is used and constructed (unconditionally valid for two-dimensions (Brandt 1998)) in the following manner:

- 1) Obtain an empirical estimate of the variogram
- 2) Compute the average azimuthal variogram from the empirical estimate to detect the directions of minimum and maximum variation,
- 3) Fit the variograms along these two axes to the spherical model for variograms
- 4) Using parameters from the fits to the spherical model and the direction for minimum variance, construct $\gamma_D(\mathbf{s}_i, \mathbf{s}_j)$ from Eqns. ((xx) – ((xxiii) below. These steps are now discussed in more detail.

Step 1: Following page 69 in Cressie (1993), the variogram for the residuals is approximated using the methods-of-moments (or classical) estimator in blocks sizes = $2d_0$ (c.f. Eqn. ((xiii))), so that

$$2\gamma(h, \theta) \approx 2\hat{\gamma}(h_i, \theta_j) = \frac{1}{|N(h_i)||N(\theta_j)|} \sum_{(a,b) \in N(h_i) \times N(\theta_j)} (R(\mathbf{s}_a) - R(\mathbf{s}_b))^2. \quad ((xv))$$

The sets $N(h_i)$ and $N(\theta_j)$ contain binned separation distances and heading angles as defined by the equations

$$N(h_i) \equiv \left\{ (a, b) : h_i - \frac{\Delta h_i}{2} \leq d(\mathbf{s}_a, \mathbf{s}_b) \leq h_i + \frac{\Delta h_i}{2} \right\} \quad ((xvi))$$

$$N(\theta_j) \equiv \left\{ (a, b) : \theta_j - \frac{\Delta \theta}{2} \leq \angle(\mathbf{s}_a, \mathbf{s}_b) \leq \theta_j + \frac{\Delta \theta}{2} \right\}, \quad ((xvii))$$

where $d(\mathbf{s}_a, \mathbf{s}_b)$ and $\angle(\mathbf{s}_a, \mathbf{s}_b)$ are the Euclidian distance and heading angle between \mathbf{s}_a and \mathbf{s}_b and $|N(h_i)|$ and $|N(\theta_j)|$ are the number of bins in these sets. For the data set analyzed in Calder (2006), $\Delta h_i = 0.05d_0$, $\Delta \theta_i = 45^\circ$, $h_i = i\Delta h + \Delta h / 2$ and $\theta_j = j\Delta \theta$.

Step 2: The average azimuthal variogram, $2\bar{\gamma}(\theta_j) \equiv |N(h_i)|^{-1} \sum_i 2\hat{\gamma}(h_i, \theta_j)$ is then calculated. In Calder (2006), $2\bar{\gamma}(\theta_j)$ had two sets of maximum and minima (caused by trending ridges), so it could be modeled by the function

$$2\bar{\gamma}(\theta_j) \approx 0.5g_0 + g_2 \cos(4\pi\theta_j + \phi_2), \quad ((xviii))$$

which is the second Fourier eigenfunction, Equation ((xviii)) is fitted to the data by evaluating the second discrete Fourier transform coefficient. The phase constant, ϕ_2 , is the radian angle (which goes counterclockwise from the east) where the first minimum is found. It is changed to a heading angle (again, clockwise from the north), θ_m , from the transformation $\theta_m \equiv -\phi_2/2 + \pi/2$. This angle is obtained for each $2d_0$ block, then interpolated to get $\theta_m(\mathbf{s}_i)$ for Step 4 below.

Step 3: Two finer-scaled directional variograms are then calculated; one in the θ_m direction, the other in the perpendicular direction, θ_m^\perp ; using the methods-of-moments estimator with angle bins of $\pm \pi/2$ about each direction. In this case, $\Delta h = 0.02d_0$ and the data were truncated to those within 95% of the mean to reduce outliers. These empirical variograms are fitted to the standard spherical variogram model (Cressie (1993), Eqn. (2.3.8); Davis (2002), Eqn. (4.98))

$$2\gamma(h) = \begin{cases} 0, & h = 0 \\ a_0 + a_1 \left(1.5(h/a_2) - 0.5(h/a_2)^3\right), & 0 \leq h/a_2 \leq 1 \\ a_0 + a_1, & h/a_2 \geq 1 \end{cases} \quad ((xix))$$

using the Levenberg-Marquardt algorithm (Marquardt 1963; Brandt 1999) for fitting (i.e. solving for a_0 , a_1 and a_2). Let the modeled variogram along the θ_m direction be $2\gamma_0(h)$ and the fitting constants be a_0 , a_1 and a_2 . Similarly, let the modeled variogram along the θ_m^\perp direction be $2\gamma_0^\perp(h)$, and the fitting constants be a_0^\perp , a_1^\perp , and a_2^\perp . When solving for both sets of constants, the variograms are constrained to equal the same sill at large distances so that $a_0^\perp = a_0$ and $a_1^\perp = a_1$, but $a_2^\perp \neq a_2$ in general.

Step 4: Define the anisotropy parameter, $\alpha_{aniso} \equiv a_2/a_2^\perp$. Then, $\gamma_D(\mathbf{s}_i, \mathbf{s}_j)$, is evaluated in the following manner.

$$\gamma_D(\mathbf{s}_i, \mathbf{s}_j) = \gamma_0(d'(\mathbf{s}_i, \mathbf{s}_j)), \quad ((xx))$$

where

$$d'(\mathbf{s}_i, \mathbf{s}_j) \equiv \|\mathbf{A}(\theta_m(\mathbf{s}_i), \alpha_{aniso})(\mathbf{s}_i - \mathbf{s}_j)\|, \quad ((xxi))$$

$$\mathbf{A}(\theta_m(\mathbf{s}_i), \alpha_{aniso}) = \mathbf{R}(-\theta_m(\mathbf{s}_i)) \text{diag}(1, \alpha_{aniso}) \mathbf{R}(\theta_m(\mathbf{s}_i)), \quad ((xxii))$$

and $\mathbf{R}(\theta_m(\mathbf{s}_i))$ is the standard two-dimensional rotational matrix (Goldstein 1980)

$$\mathbf{R}(\theta_m(\mathbf{s}_i)) = \begin{bmatrix} \cos(\theta_m(\mathbf{s}_i)) & \sin(\theta_m(\mathbf{s}_i)) \\ -\sin(\theta_m(\mathbf{s}_i)) & \cos(\theta_m(\mathbf{s}_i)) \end{bmatrix}. \quad ((xxiii))$$

For applications where only the bathymetry is needed, $\gamma_D(\mathbf{s}_i, \mathbf{s}_j)$, may be sufficient for use. In hydrographic situations, however, where extra caution is required for navigation safety, an additional ‘‘hydrographic uncertainty’’ variogram is added to increase the total uncertainty for safety (see Calder (2006) for details). This variogram is defined to be

$$2\gamma_H(h) \equiv b_0 + b_1 h \quad ((xxiv))$$

The choice of the coefficients is arbitrary, but Calder uses $b_0 \equiv 0$ and $b_1 \equiv 6.51 \times 10^{-4}$ m so that the 95% confidence interval of the uncertainty increases by 0.05 m for every meter of horizontal separation in soundings. Thus, for hydrography, the final variogram to use is

$$2\gamma_{total}(\mathbf{s}_i, \mathbf{s}_j) = 2\gamma_D(\mathbf{s}_i, \mathbf{s}_j) + 2\gamma_H(\|\mathbf{s}_j - \mathbf{s}_i\|) \quad ((xxv))$$

3. Monte Carlo Estimation of Depth Error Due to Positional Stability Errors

This last part is of use for fusion with soundings data, either with other soundings data or a historical grid, as the position of the soundings contains errors (this part is not applied when fusing historical gridded data sets). As before (c.f. Section I.A), positioning errors result in errors of depth estimates on the interpolation surface as the position of the soundings affect the interpolated solution; the Monte Carlo technique of Jakobsson et al. (2002) is used to estimate this error. At the beginning of each iteration, the locations of the soundings are perturbed according to a probability density function appropriate for the sounding, often assumed to be Gaussian unless otherwise known (c.f. Fig. 5 in Calder (2006) for a non-Gaussian example). Loess interpolation and kriging, using the variogram from the unperturbed set, are repeated at each iteration. The standard deviation of the solutions at each interpolation point provides $\varepsilon(\mathbf{s})$ in Eqn. ((x)).

Acknowledgements

This work is funded through the Office of Naval Research, Naval Research Laboratory base program. The mention of commercial products or the use of company names does not in any way imply endorsement by the U.S. Navy.

References

- (2008). Netica, Version 4.0.8. Vancouver, BC, Norsys Software Corporation.
- Brandt, S. (1998). Data analysis : statistical and computational methods for scientists and engineers. New York, Springer.
- Brandt, S. (1999). Data Analysis: Statistical and Computational Methods for Scientists and Engineers New York, Springer.
- Calder, B. (2006). "On the uncertainty of archive hydrographic data sets." IEEE Journal of Oceanic Engineering **31**(2): 249-265.
- Cleveland, W. S. (1979). "Robust locally weighted regression and smoothing scatterplots." Journal of the American Statistical Association **74**(368): 829-836.
- Cleveland, W. S. and S. J. Devlin (1988). "Locally weighted regression - an approach to regression-analysis by local fitting" Journal of the American Statistical Association **83**(403): 596-610.
- Cressie, N. A. C. (1993). Statistics for Spatial Data. New York, Wiley.
- Davis, J. C. (2002). Statistics and Data Analysis in Geology. New York, Wiley.
- Elmore, P. A., D. H. Fabre, et al. (2009). Uncertainty estimation of historical bathymetric data from Bayesian networks. OCEANS 2009, MTS/IEEE Biloxi - Marine Technology for Our Future: Global and Local Challenges.
- Givens, G. H. and J. A. Hoeting (2005). Computational Statistics. Hoboken, NJ, Wiley-Interscience.
- Goldstein, H. (1980). Classical Mechanics. Reading, MA, Addison Wesley.

-
- Jakobsson, M., B. Calder, et al. (2002). "On the effect of random errors in gridded bathymetric compilations." Journal of Geophysical Research-Solid Earth **107**(B12): Article 2358.
- Mahalanobis, P. C. (1936). "On the generalised distance in statistics." Proceedings of the National Institute of Science of India **12**: 49-55.
- Marquardt, D. W. (1963). "An algorithm for least-squares estimation of nonlinear parameters." Journal of the Society for Industrial and Applied Mathematics **11**(2): 431-441.
- Marsaglia, G. and W. W. Tsang (2000). "The Ziggurat Method for Generating Random Variables." Journal of Statistical Software **5**.
- Oksanen, J. and T. Sarjakoski (2005). "Error propagation of DEM-based surface derivatives." Computers & Geosciences **31**(8): 1015-1027.
- Plant, N. G., K. T. Holland, et al. (2002). "Analysis of the scale of errors in nearshore bathymetric data." Marine Geology **191**(1-2): 71-86.
- Russell, S. J. and P. Norvig (2003). Artificial Intelligence: A Modern Approach. Upper Saddle River, N.J., Prentice Hall/Pearson Education.
- Zhou, Q. M. and X. J. Liu (2004). "Error analysis on grid-based slope and aspect algorithms." Photogrammetric Engineering and Remote Sensing **70**(8): 957-962.

10.2.6 Error Growth Model

The following has been extracted from 5th Edition, S-44 (2008) Annex A, section A.5 by Rob Hare and edited for context

TPU is a combination of random and bias based uncertainties. Random and short period uncertainties have to be recognized and evaluated both in horizontal and vertical directions.

The propagated uncertainty may be expressed as a variance (in metres²) but is more often reported as an *uncertainty* (in metres) derived from variance with the assumption that the uncertainty follows a known distribution. In the latter case, the confidence level (e.g., 95%) and the assumed distribution shall be documented. Horizontal uncertainties are generally expressed as a single value at a 95% level, implying an isotropic (circular) distribution of uncertainty on the horizontal plane.

In the hydrographic survey process it is necessary to model certain long period or constant factors related to the physical environment (e.g. tides, sound speed, vessel dynamic draft, including squat of the survey vessel). Inadequate models may lead to bias type uncertainties in the survey results. These uncertainties shall be evaluated separately from random type uncertainties.

TPU is the resultant of these two main uncertainties. The conservative way of calculating the result is the arithmetic sum, although users should be aware that this may significantly

overestimate the total uncertainty. Most practitioners, and the appropriate ISO standard, recommend quadratic summation (i.e., summation of suitably scaled variances).

An example is given in S-44 for fixed (a) and depth-variable (b) uncertainty components:

$$\text{TVU} = \pm \sqrt{a^2 + (b \times d)^2}$$

10.2.7 Split-Sample Approach

Contributed by Chris Amante and Matt Love, NOAA National Centers for Environmental Information (NCEI)

There are a number of techniques used to quantify the uncertainty of interpolated elevations, e.g., split-sample, cross-validation, jack-knifing, and boot-strapping. Using a split-sample approach, a percentage of the data is omitted, an interpolation method is applied, and the differences between the interpolated elevations and the original omitted elevations are calculated. This method is often used to assess the stability of various interpolation methods by omitting increasingly greater percentages of the original data and analyzing changes in the uncertainty.

A program for Linux users written in Guile Scheme (<http://www.gnu.org/s/guile/>) has been developed to quantify the uncertainty of interpolation methods using a split-sample approach. The program, named `ss_unc.sch`, utilizes the Generic Mapping Tools (GMT; <http://gmt.soest.hawaii.edu>), and ancillary programs written in the C programming language by Matthew Love of the National Oceanic and Atmospheric Administration (NOAA) National Centers for Environmental Information (NCEI; see glossary).

The program omits a percentage of the xyz points, applies an interpolation method, and calculates the differences between the interpolated values and the omitted elevations. In order to quantify the uncertainty of the interpolation method at every data point, the program repeats this process and aggregates the differences between the original xyz file and the interpolated elevations. The program produces several useful products to be used in assessing the uncertainty of various interpolation methods. The products include a histogram (see Figure 10.2.7.1) of the differences with statistical measurements such as the minimum, maximum, mean, root mean squared error (RMSE), and standard deviation. In addition, the program produces a binary .grd file of the differences between the original and interpolated elevations.

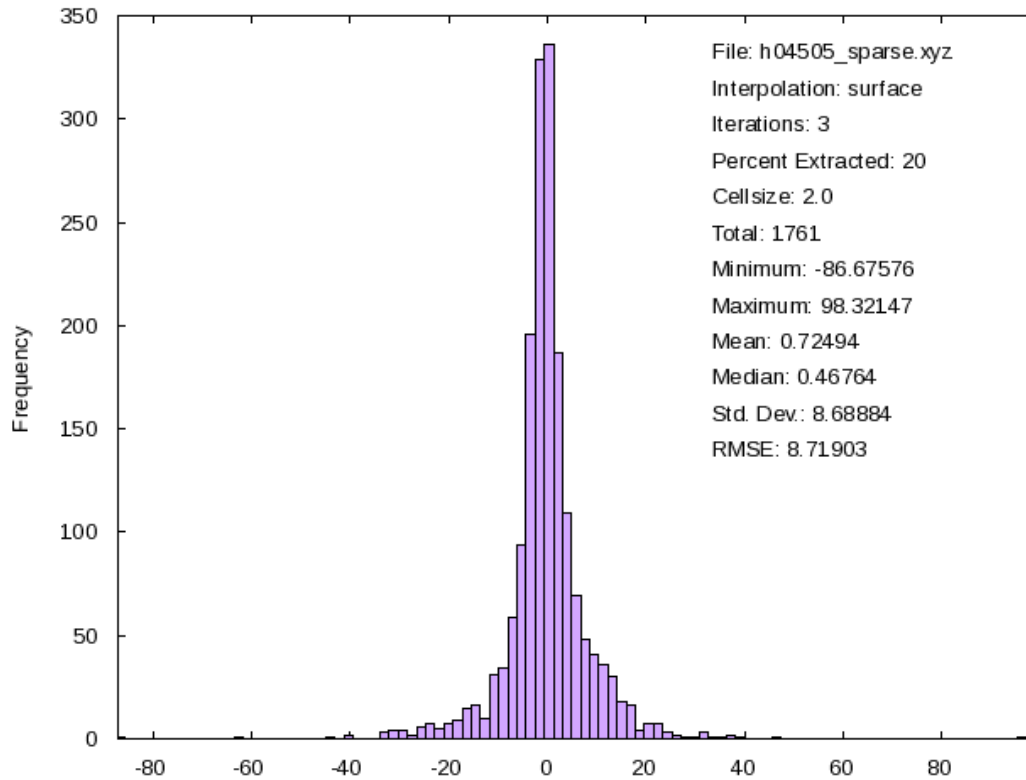

Figure 10.10 Example histogram output from Split-Sample program SS_UNC.

The program has multiple user-defined parameters. The user defines the input xyz file to be used to evaluate multiple gridding methods, the gridding methods to evaluate, the percentage of points to be omitted, the grid cell size, the input xyz file delimiter, and the number of iterations to repeat the process (see example below). Currently the program can evaluate GMT 'surface,' 'nearneighbor,' and 'triangulate' gridding algorithms. Additional gridding algorithms, such as MB-System 'mbgrid,' will be included in the program in the near future.

ss_unc.scm [infile] [-e arg] [-percent arg] [-grd_cells arg] [-delimiter arg] [-dotimes arg] [-engines? arg] [-help]

infile	The input xyz file
-e	Specify which gridding engine(s) to use. If multiple engines are desired, separate them with commas.
-percent	Percentage of xyz data to extract, default is 20.
-grd_cells	The grid cell size in arc-seconds.
-delimiter	The input xyz delimiter
-dotimes	The number of iterations
-engines?	Check available engines
-help	Display the help

Split-sample uncertainty program example:

```
~| ss_unc.scm h04505_sparse.xyz -e surface, nearneighbor, triangulate -percent 25 -  
grd_cells 100 -delimiter "," -dotimes 10 > ss_unc_example.sh
```

```
~| chmod +x ss_unc_example.sh
```

```
~| ./ss_unc_example.sh
```

Another option currently in progress is to evaluate the stability of the interpolation method by omitting an increasingly greater percentage of original data. For example, omit 20% of the original data and increase the percentage of omitted data at 10% intervals until 80% of the original data has been omitted. This option will produce a line graph depicting the change in RMSE as a function of the percentage of points omitted for various interpolation methods.

SS UNC

SS UNC

Compare interpolation gridding methods to help determine uncertainty.

Matthew Love

Copyright © 2011 CIRES.

Permission is granted to make and distribute verbatim copies of this manual provided the copyright notice and this permission notice are preserved on all copies. Permission is granted to copy and distribute modified versions of this manual under the conditions for verbatim copying, provided that the entire resulting derived work is distributed under the terms of a permission notice identical to this one.

1 Copying

SS UNC is copyright (C) 2011 CIRES and is released under the terms of the GNU General Public License. See the included file ‘COPYING’ for the full text of the license (or see [section “Copying”](#) in [The GNU Emacs Manual](#)).

This is free software – you are welcome to redistribute it and/or modify it under the terms of the GNU General Public License as published by the Free Software Foundation; either version 2, or (at your option) any later version.

SS UNC is distributed in the hope that it will be useful, but WITHOUT ANY WARRANTY; without even the implied warranty of MERCHANTABILITY or FITNESS FOR A PARTICULAR PURPOSE. See the GNU General Public License for more details.

2 Introduction

The Split Sample UNCertainty program (SS UNC) is a Guile scheme command-line program designed to run on the GNU/Linux Operating System. SS UNC is highly configurable, allowing the user to add gridding engines, change and add command-line options, and even change the way SS UNC runs.

3 Installing SS UNC

3.1 Dependencies

For SS UNC to work, there are a number of required dependencies:

- GNU/Linux
- Guile
- GMT
- rpslit
- ncquery

3.2 Autotools

Installation through autotools is fairly straight forward.

1. Unpack the package

```
~] tar xfvz ss_unc-0.1.tar.gz
```

2. Enter the package root directory

```
~] cd ss_unc-0.1
```

3. Configure and Make the package

The '--prefix' switch to ./configure specifies where to install files.

```
~/ss_unc-0.1] ./configure --prefix=~/.ss_unc && make
```

4. Install the built package

```
~/ss_unc-0.1] make install
```

3.3 Manual Installation

1. Unpack the package

```
~] tar xfvz ss_unc-0.1.tar.gz
```

2. Enter the package root directory

```
~] cd ss_unc-0.1
```

3. Enter the package 'src' directory

```
~] cd src
```

4. Copy ss_unc.scm to a directory locatable with PATH

```
~] cp ss_unc.scm ~/bin
```

4 Using SS UNC

SS UNC is a command-line program designed to be run in a shell program such as bash.

4.1 Basic Usage

For general usage help from the command-line, the ‘-help’ switch can be used. The usage display will display the default command-line switches as well as any additional switches defined by the user, see [Section 5.2 \[Adding Command Line Options\]](#), page 6. The ‘-e’ switch specifies the gridding engine to use in gridding comparisons, see [Section 5.1 \[Adding Engines\]](#), page 6.

```
~] ss_unc.scm -help
```

```
ss_unc.scm version 0.2.0
```

```
Usage: ss_unc.scm [infile] [-e arg] [-percent arg] [-grd_cells arg]
        [-delimiter arg] [-dotimes arg] [-engines? arg] [-help]
```

infile	The input xyz file.
-delimiter	The input xyz record delimiter, default is space (“ “)
-e	Specify which gridding engine(s) to use, if multiple engines are desired, separate them with commas.
-percent	Percentage of xyz data to extract, default is 20, separate values with a comma.
-grd_cells	The grid cell size -dotimes The number of iterations -engines? Check available engines, optionally specify which engine to get more information about..
-help	Display the help

infile

The infile is the input xyz file to perform the gridding algorithms on.

-e

The -e switch specifies which gridding engine(s) to use. To use multiple engines, separate the engine names with a comma, this will produce histograms and stat files for each of the engines mentioned.

-percent

The -percent switch specifies the percentage of random points to extract from infile. If the argument is a list of comma separated values, ss_unc.scm will run for each of the specified percentages, and append the statistics for each into a separate file.

-grd cells

The -grd_cells switch specifies the cell-size to use for gridding operations.

-dotimes

The -dotimes switch allows the user to specify how many iterations of gridding and comparing will be performed.

-engines?

The -engines? switch without arguments will display a list of the available gridding engines, optionally specify an engine as an argument to get more details about that engine.

-help

This switch will display the help text and exit.

When `ss_unc.scm` is run, it will immediately output a number of commands to `stdin`. If these commands are redirected to a file, e.g. `> ss_unc_test.sh`, then that file can be used to generate the output files. The generated script can be edited to fine-tune some of the commands if needed and can be saved for future use.

4.2 Default Engines

SS UNC comes with a number of gridding engines for general use. To check which engines are available on the running version of SS UNC, use the `'-engines?` switch, which will display all the engine keys which would be used with the `'-e` option, including those added by the user, see [Section 5.1 \[Adding Engines\], page 6](#).

Each of the search engines has a description, which can be displayed by specifying which engine to display more information about after the `'-engines?` switch:

```
~] ss_unc.scm -engines?
```

```
surface
```

```
nearneighbor
```

```
triangulate
```

```
~] ss_unc.scm -engines? surface
```

```
surface
```

```
GMT surface (SPLINE)
```

4.3 Output

SS UNC will generate a number of output files. The type and number of output files will depend on the given command-line arguments.

- Histogram(s)
- Difference Grid(s)
- Statistics file(s)

5 Extending SS UNC

SS UNC allows for complete extensibility. By use of hooks and definitions, one could rewrite SS UNC to ones own desires.

5.1 Adding Engines

SS UNC allows for the adding of new gridding engines. This is accomplished through the configuration file (`~/ss_unc`). The scheme function `'ci-add-engine` is used to add a new gridding engine into SS UNC:

```
(si-add-engine '(engine-name .  
                ('engine-function "engine-description"))))
```

where `engine-function` is a function which should accept 2 arguments (`input-xyz-file` and `gridding-cell-size`) and `engine-description` is a string describing the engine. Adding an engine in this manner will add the engine to the output of the `-engines?` command-line switch, seamlessly integrating the added engines into the SS UNC interface.

5.2 Adding Command Line Options

SS UNC allows for the adding of new command-line options. There are two steps involved in adding command-line options, adding the option to the help menu and adding a handling function to the command-line hook.

```
(define switch-var #f)  
  
  (sc-add-option '(-switch . (takes-options?(#t or #f)  
                        "Description")) (add-hook! ci-command-line-hook  
  (lambda (a b)  
    (if (equal? (car b) "-show_url")  
  (begin  
    (set! show-url #t)  
    (parse-options a (cdr b)))))))
```

5.3 Hooks

Hooks are a useful tool in extending scheme code. SS UNC takes advantage of hooks to allow the user the ability to add command-line options (including in the `-help` output).

SS UNC provides one hook, listed and described below:

`ci-command-line-hook`

The `'sc-command-line-hook` is the hook that allows adding to the default command-line options. The hook is run before the general command-line parsing begins, allowing the user to have control over the command-line environment. This hook is passed 2 options, the first is the command that ran the program (e.g. `/usr/bin/sicl`) and the second is the remaining command-line options. The hook will be run for each command-line option, so the user doesn't have to write any loops in the configuration files to take advantage of adding command-line options in this manner.

6 Examples

Running ss unc.scm

Run ss unc.scm on the comma delimited ascii xyz file test.xyz, randomly extracting 25 percent of the data points, gridding using surface and triangulate at 10 arc-seconds.

```
#run the command
~] ss_unc.scm test.xyz -percent 25 -e surface,triangulate \

-grd_cells 10 -delimiter “,” > test.sh

#Allow the output script to be executable
~] chmod +x test.sh

#Run the output script
~] ./test.sh
```

Re-Define the 'surface engine function

Redefine the 'surface engine function in the SS UNC configuration file, adding a tension parameter.

```
(define (run-surface in cellsize)
  (display (string-append
            "surface "
            in
            " -I"
            cellsize
            "c -T.4 -G"
            (basename in ".xyz") "_surface.grd"
            " $(minmax " in " -I" cellsize "c)"))
  (newline))
```

SS_UNC.SCM

SS_UNC

ss_unc.scm

1/6

~/

02/28/2011

```
#!/usr/bin/guile \
-e main -s
!#

;;---

(use-modules (ice-9 rdelim))

(define percent "20")
(define inxyz `())
(define grdcellsize "1")
(define do-times "2")
(define outps "out.ps")
(define delim " ")
(define version-wanted? #f)
(define help-wanted? #f)

;;-----;;
;; Engines ;;
;;-----;;
;;
;; Define some hooks.

(define ci-command-line-hook (make-hook 2))

;; The User Config File, this can be set in the .guile config file.

(if (not (defined? `ci-config))
    (define ci-config
      (cond ((file-exists? (string-append (getenv "HOME") "/.ss_unc.conf"))
             (string-append (getenv "HOME") "/.ss_unc.conf"))
            ((file-exists? (string-append (getenv "HOME") "/.ss_unc"))
             (string-append (getenv "HOME") "/.ss_unc")))))

;; The list of default engines. Formatted
;; thusly: `(name . (function "description"))
;; The `function should accept 2 arguments,
;; the input xyz file and the gridding cellsize

(define ci-engine-alist

  `((surface . (run-surface "GMT surface (SPLINE) \n"))
    (triangulate . (run-triangulate "GMT triangulate (Triangulation) \n"))
    (nearneighbor . (run-nn "GMT nearneighbor (NEAREST NEIGHBOR) \n"))))

(define (ci-add-engine specs)

  "Add a gridding engine to the `ci-engine-alist in the format
`(name . function \"description\")"

  (append! ci-engine-alist (list specs)))

(define (ci-display-engines engine-alist)
```

"Display the available engines in the given 'engine-alist."

```
(if (pair? engine-alist)
    (begin
      (display (caar engine-alist))
      (newline)
      (ci-display-engines (cdr engine-alist))))))
```

```
(define (ci-describe-engine ci-eng engine-alist)
```

"Describe 'ci-eng using the given 'engine-alist"

```
(display ci-eng)
(newline)
(display "-----")
(newline)
(if (and (assq (string->symbol ci-eng) engine-alist)
         (not (null? (caddr (assq (string->symbol ci-eng) engine-alist)))))
    (display (caddr (assq (string->symbol ci-eng) engine-alist)))
    (display "Sorry, this engine has no description available.))

(newline))
```

```
::---
```

```
::---Engine functions:
```

```
(define (run-surface in cellsize)
  (display (string-append
            "surface "
            in
            "-I"
            cellsize
            "c -G"
            (basename in ".xyz") "_surface.grd"
            "$(minmax " in "-I" cellsize "c)"))

  (newline))
```

```
(define (run-nn in cellsize)
  (display (string-append
```

```
    "nearneighbor "
    in
    "-I"
```

```

        cellsize

        "c -S20c -N8 -V -G"
        (basename in ".xyz") "_nearneighbor.grd"
        "$(minmax " in "-I" cellsize "c)")

(newline))

(define (run-triangulate in cellsize)
  (display (string-append

    "triangulate "

    in

    "-I"

    cellsize

    "c -G"
    (basename in ".xyz") "_triangulate.grd"
    "$(minmax " in "-I" cellsize "c) > tmp.idk")))

(newline))

;;---

;;---PROC:

(define (run-rsplit in percentage)
  (display (string-append

    "rsplit --percent "

    percentage

    "-r " in " > rand_"
    (basename in)

    " 2>base_"

    (basename in)))

(newline))

(define (run-ncquery ingrd inxyz delim d_format outxyz)
  (display (string-append

    "ncquery -r "

    d_format

    "-g "

```

```

    ingrd

    "-i "

    inxyz

    "-d "

    delim

    "| grep -v \"nan\" >> "

    outxyz))
(newline)
(define (run-xyz2grd inxyz outgrd cellsize)
  (display (string-append

    "awk -F"

    delim

    "' {print $1,$2,$5}' | "
    "xyz2grd "

    inxyz

    "-V -I"

    cellsize

    "c -G"

    outgrd
    " $(minmax " inxyz " -I" cellsize "c)")
    (newline))
;;---STATS:

(define (run-pshistogram inxyz outps rperc ptimes engine)
  (display
  (string-append

    "pshistogram "

    inxyz

```

```

-V -Gblue -W$(minmax -C "
inxyz " | awk '{print ($10-$9)*.10}' -L1 -Z0 -T4
-B:"Value"/:"Frequency"/:"WSne -U/-2
5i/-0.75i/"ss_unc.scm" -K > "
outps " 2>" outps ".info")
(newline)

```

```

(define (run-pstext inxyz outps
  rperc ptimes engine)
  (display
    (string-append

```

```

"pstext -R0/3/0/5 -JX3i -O -N -V << EOF >> "

```

```

outps

```

```

"\n.25 11.5 10 0 0 LT Iterations: " ptimes

```

```

"\n.25 11 10 0 0 LT Percent: " rperc

```

```

"\n.25 10.5 10 0 0 LT Cell-Size: " grdcellsize

```

```

"\n1.5 11.5 10 0 0 LT Total: $(wc -l " inxyz " | awk '{print $1}')"

```

```

"\n1.5 11 10 0 0 LT Min: $(grep min/max " outps ".info | awk '{print $6}')"

```

```

"\n1.5 10.5 10 0 0 LT Max: $(grep min/max " outps ".info | awk '{print $7}')"

```

```

"\n2.75 11.5 10 0 0 LT Mean: $(tail -1 "

```

```

(basename inxyz ".xyzgd") ".stat | awk '{print $4}')"

```

```

"\n2.75 11 10 0 0 LT RMSE: $(tail -1 "

```

```

(basename inxyz ".xyzgd") ".stat | awk '{print $5}')"

```

```

"\n4 11.5 10 0 0 LT File: " inxyz

```

```

"\n4 11 10 0 0 LT Interpolation: " engine

```

```

" \nEOF"))

```

```

(newline)

```

```

(define (set-gmt-defaults)

```

```

  (display "gmtset COLOR_NAN 255/255/255 DOTS_PR_INCH 300 ANNOT_FONT_PRIMARY Times-Roman \
ANNOT_FONT_SIZE_PRIMARY 8 ANNOT_FONT_SIZE_SECONDARY 8 HEADER_FONT Times-Roman \
LABEL_FONT Times-Roman LABEL_FONT_SIZE 8 HEADER_FONT_SIZE 10 PAPER_MEDIA letter \
UNIX_TIME_POS 0i/-1i PS_COLOR_CMYK Y_AXIS_TYPE ver_text PLOT_DEGREE_FORMAT ddd:mm:ss \
D_FORMAT %.1f COLOR_BACKGROUND 0/0/0 COLOR_FOREGROUND 255/255/255 COLOR_NAN 255/255/255")

```

```

(newline)

```

```

(define (run-stats inxyz outxyz rperc ptimes grdcellsize)

```

```

  (display (string-append

```

```

    "awk -F" delim " '{sum+=$5} {sum2+=$(5*5)} END { print \"\"
    rperc "\",\"\" ptimes "\",\"\" grdcellsize "\",sum/NR,sqrt(sum2/NR)}' "
    inxyz " >> " outxyz))

```

```

(newline)

```

```

  (define (run-ps2raster psfile outf)

```

```

    (display (string-append

```

```

"ps2raster -T" outf " " psfile))
(newline))

;;-----

;;-----;;
;; Run-Commands ;;
;;-----;;

;;-----Run through the commands

(define (run-commands
  run-times engines p)
  (let ((engine-list
        (string-split engines #\,)))
    (if (> run-times 0)
        (begin
          (let ((base-xyz
                (string-append "base_"
                               (basename inxyz))))
            (rand-xyz (string-append "rand_" (basename inxyz))))
            (run-rsplit inxyz p)
            (map (lambda (x)

                   (primitive-eval
                    (list (cadr (cadr (assq
                                     (string->symbol x)
                                     ci-engine-alist)))
                          base-xyz grdcellsize)))
                  engine-list)
                (map (lambda (x)

                       (run-ncquery
                        (string-append (basename base-xyz ".xyz") "_" x ".grd")
                        rand-xyz
                        delim

                        "xyzgd"
                        (string-append "rand_" p "_"

                                       (basename
                                        inxyz ".xyz") "_" x ".xyzgd"))))
                      engine-list)
                    (run-commands (- run-times 1)
                    engines p)))
          (begin
            (map (lambda (x)

                   (run-xyz2grd
                    (string-append "rand_" p "_"
                                   (basename inxyz ".xyz") "_" x
                                   ".xyzgd")
                    (string-append "rand_" p "_"
                                   (basename inxyz ".xyz") "_" x
                                   ".xyzgd.grd")
                    grdcellsize)
                  engine-list)
                (map (lambda (x)

                       (run-stats (string-append "rand_" p
                                                  "_"
                                                  (basename inxyz ".xyz") "_" x
                                                  ".xyzgd")
                                   (string-append "rand_"
                                                  (basename inxyz ".xyz") "_" x ".stat")

```

```

        p do-times grdcellsize)
      (run-stats (string-append "rand_" p
        " "
        (basename inxyz ".xyz") "_" x
        ".xyzgd")
        (string-append "rand_" p " "
        (basename inxyz ".xyz") "_" x ".stat")
        p do-times grdcellsize))

      engine-list)
    (set-gmt-defaults)
    (map (lambda (x)

      (run-psistogram
        (string-append "rand_" p " " (basename inxyz ".xyz") "_" x ".xyzgd")
        (string-append "rand_" p " " (basename inxyz ".xyz") "_" x ".ps")
        p do-times x))

      engine-list)
    (map (lambda (x)

      (run-pstext
        (string-append "rand_" p " " (basename inxyz ".xyz") "_" x ".xyzgd")
        (string-append "rand_" p " " (basename inxyz ".xyz") "_" x ".ps")
        p do-times x))

      engine-list)
    (map (lambda (x)

      (run-ps2raster
        (string-append "rand_" p " " (basename inxyz ".xyz") "_" x ".ps")
        "G"))

      engine-list))))

;;-----
;;-----
;; Command-line options ;;
;;-----
;;-----

;;---Options
;; '(switch . (args? "desc"))

(define ci-option-alist '((infile . (#f "The input xyz file."))
  (-e . (#t "Specify which gridding engine(s) to use, \
if multiple engines are desired, separate them with commas."))
  (-percent . (#t "Percentage of xyz data to extract, default is 20"))
  (-grd_cells . (#t "The grid cell size"))
  (-delimiter . (#t "The input xyz delimiter"))
  (-dotimes . (#t "The number of iterations"))
  (-engines? . (#t "Check available engines, optionally specify \
which engine to get more information about.."))
  (-help . (#f "Display the help"))))

(define (ci-add-option specs)
  (append! ci-option-alist (list specs)))

(define (ci-display-options
  option-list)

```

```

(if (pair? option-list)
  (begin
    (if (cadar option-list)
      (display (string-append " [" (symbol->string (caar option-list)) " arg]"))
      (display (string-append " [" (symbol->string (caar option-list)) "]")))

    (ci-display-options (cdr option-list)))
  (display "\n\n"))

(define (ci-describe-options option-list)
  (if (pair? option-list)
    (begin
      (let ((cname (symbol->string (caar option-list)))
            (cdesc (caddr (car option-list))))
        (if (> 20 (string-length cname))

            (display (string-append
                      (string-append
                       cname
                       (make-string (- 20 (string-length cname)) #\ )
                      "\t" cdesc "\n"))))
          (ci-describe-options (cdr option-list)))
      (display "\n")))

  (define (display-help command-name option-list)
    (if (pair? option-list)

        (begin
          (display (basename command-name))
          (display " version 0.2.1")
          (newline)
          (display "Usage: ")
          (display (basename command-name))
          (ci-display-options option-list)
          (ci-describe-options option-list))))

```

;; Read the given port (p) and put it into the string pstring.

```

(define (read-port p pstring)

  (if (not (eof-object? (peek-char p)))
      (read-port p (string-append pstring (read-line p)))
      pstring))

```

;; Parse the command-line

```

(define (parse-options cca ccl)
  (if (pair? ccl)
    (begin
      (if (not (hook-empty? ci-command-line-hook))
        (run-hook ci-command-line-hook cca ccl))
      (cond

        ;; Help? ;;

        ((or (equal? (car ccl) "-h")
              (equal? (car ccl) "--help")
              (equal? (car ccl) "-?"))

         (display-help cca ci-option-alist)

```

```

(exit 1))

((equal? (car ccl) "-percent")

(begin
  (set! percent (cadr ccl))
  (parse-options cca (cddr ccl))))

;; Engines ;;

((equal? (car ccl) "-engines?")

(if (not (null? (cdr ccl)))
    (ci-describe-engine (cadr ccl) ci-engine-alist)
    (ci-display-engines ci-engine-alist)))

(exit 1))

;; Gridding Engine ;;

((equal? (car ccl) "-e")

(begin
  (set! ci-engine (cadr ccl))
  (parse-options cca (cddr ccl))))

((equal? (car ccl) "-delimiter")

(begin
  (set! delim (cadr ccl))
  (parse-options cca (cddr ccl))))

((equal? (car ccl) "-grd_cells")

(begin

  (set! grdcellsz (cadr ccl))
  (parse-options cca (cddr ccl))))

((equal? (car ccl) "-dotimes")

(begin
  (set! do-times (cadr ccl))
  (parse-options cca (cddr ccl))))

;; Input xyz file ;;

((null? inxyz)
 (set! inxyz (car ccl))
 (parse-options cca (cdr ccl)))

(else
 (parse-options cca (cdr ccl))))

;; Load the User Config File
;(display ci-config)

(if (file-exists? ci-config)
    (begin
      (load ci-config)))

```

```
(if (not (defined? 'ci-engine))
    (define ci-engine "surface"))

(define (main args)

  ;; Parse the command-line

  (parse-options (car (command-line)) (cdr (command-line)))

  ;; If 'inxyz was not given, get it from 'current-input-port

  (if (null? inxyz)
      (set! inxyz (read-port (current-input-port) "")))

  ;(display inxyz)

  (let ((percent-list (string-split percent #\,)))
    (map (lambda (p)
          (run-commands (string->number do-times) ci-engine p))
         percent-list)))

;;--END
```

RSPLIT
RSPLIT

Randomly extract lines from a text file.
Manual

Matthew Love

Copyright © 2011 Matthew Love.

Permission is granted to make and distribute verbatim copies of this manual provided the copyright notice and this permission notice are preserved on all copies. Permission is granted to copy and distribute modified versions of this manual under the conditions for verbatim copying, provided that the entire resulting derived work is distributed under the terms of a permission notice identical to this one.

1 Copying

RSPLIT is copyright (C) 2011 Matthew Love and is released under the terms of the GNU General Public License. See the included file ‘COPYING’ for the full text of the license (or see Section “Copying” in The GNU Emacs Manual).

This is free software – you are welcome to redistribute it and/or modify it under the terms of the GNU General Public License as published by the Free Software Foundation; either version 2, or (at your option) any later version.

rsplit is distributed in the hope that it will be useful, but WITHOUT ANY WARRANTY; without even the implied warranty of MERCHANTABILITY or FITNESS FOR A PARTICULAR PURPOSE. See the GNU General Public License for more details.

2 Introduction

Randomly extract a percentage of lines from a text file. The randomly extracted line gets printed to stdout, optionally, the remaining lines can be printed to stderr, allowing for the splitting of text files.

3 Installing rsplit

Installation through autotools is fairly straight forward.

1. Unpack the package
~] tar xfvz rsplit-0.1.3.tar.gz
2. Enter the package root directory
~] cd rsplit-0.1.3
3. Configure and Make the package
The '--prefix' switch to ./configure specifies where to install files.
~/rsplit-0.1.3] ./configure --prefix=~/.rsplit && make
4. Install the built package
~/rsplit] make install

4 Using rsplit

RSPLIT is a command-line program designed to be run in a shell program such as bash. For general usage help from the command-line, the '--help' switch can be used.

~] rsplit --help

Usage: rsplit [OPTIONS] [infile]

Randomly extract a percentage of lines from a text file.

Options:

-p, --percent The percent of lines to randomly extract from the input.

-l, --line-num Include line numbers in output.

-r, --remaining Send the lines that aren't extracted to stderr.

--version Print version information and exit.

Example: rsplit test.xyz -p 20 -lr > test_rand20.xyz 2>test_base.xyz

The '-p, --percent' switch specifies the percentage of randomly selected points to extract from the given text file.

The '-l, --line-num' switch prints the line number along with the original line from the input text file.

The '-r, --remaining' switch prints the remaining lines after random extraction to stderr.

5 Examples

Extract 20 percent of the lines in the input text file and print the results to stdout `~] rsplit -p 20 input.txt`

Extract 15 percent of the lines in the input text file and write the results to a file, include the line numbers `~] rsplit -p 20 --line-num input.txt > rand20_input.txt`

Extract 40 percent of the lines in the input text file, write the results to a file and send the remaining lines to another file. `~] rsplit test.xyz -p 40 -r >`

`test_rand40.xyz 2>test_base60.xyz`

10.2.8 Spectral analysis

10.2.9 Slope

10.2.10 *Kriging discussion and cautionary note*

10.3 Sharing uncertainty results

TEXT IN PREPARATION

10.3.1 ASCII files

TEXT IN PREPARATION

10.3.2 netCDF files

TEXT IN PREPARATION

10.3.3 “BAG” files

Contributed by Rob Hare, Canadian Hydrographic Service, Canada

Bathymetric Attributed Grid (BAG) is a non-proprietary file format for storing and exchanging bathymetric data developed by the Open Navigation Surface Working Group. BAG files are

gridded, multi-dimensional bathymetric data files that contain position and depth grid data, as well as position and uncertainty grid data, and the metadata specific to that BAG file. Information about BAG files may be obtained from the Open Navigation Surface website:

<http://www.opennavsurf.org/whitepapers.html>

Chapter 11.0 LANDSAT 8 Satellite-Derived Bathymetry

Contributed by S. Pe'eri, B. Madore and L. Alexander, Center for Coastal and Ocean Mapping, USA, A. Klemm and A. Armstrong, National Oceanic and Atmospheric Administration, USA, C. Parrish, Oregon State University, USA, C. Azuike, Nigerian Navy Hydrographic Office Lagos, Nigeria, and Eunice N. Tetteh, Ghana National Oceanographic Data Centre, Ghana

Satellite derived bathymetry (SDB) is a useful reconnaissance tool that can be used to map near-shore bathymetry, characterize a coastal area and to monitor seafloor changes that may have occurred since the last hydrographic survey was conducted. Landsat satellite imagery is most commonly used for SDB products because it is a free and publicly available resource. Satellite imagery in the U.S. Geological Survey data archives includes imagery from current and previous Landsat missions. In the current Landsat 8 mission, an operational land imager (OLI) has been operational since mid-2013. The swath width of the Landsat imagery is 185 km, and the image resolution is 30 m. The number of bands and their spectral range differs between Landsat missions (Figure 11.1). In addition to Landsat imagery, there are several commercial multispectral satellite platforms (e.g., Ikonos and WorldView) that can also be used for satellite derived bathymetry.

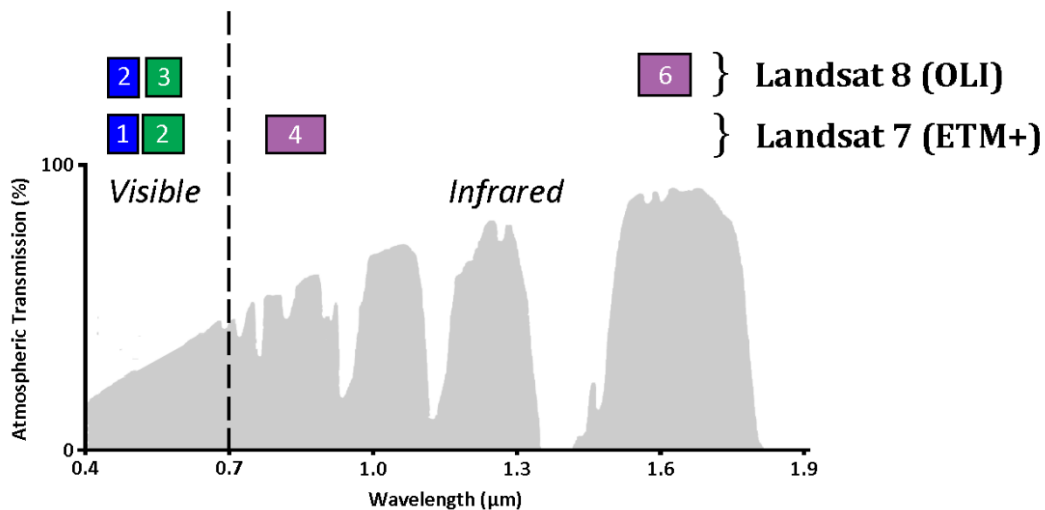

Figure 11.1 Bands of Landsat 7 and 8 imagery used in the SDB procedure.

This chapter will describe the SDB procedure step-by-step using Landsat 8 imagery. The procedure is described in an ESRI ArcMap environment and includes the following key steps in the satellite-derived procedure include (Pe'eri et al., 2014):

- **Pre-processing (Section 11.1)**– Satellite imagery is downloaded based on the geographic location and environmental conditions (e.g., cloud coverage and sun glint) had to be used.
- **Spatial filtering (Section 11.2)**– ‘Speckle noise’ in the Landsat imagery is removed using spatial filtering.
- **Water separation (section 11.2)**– Dry land and most of the clouds are removed.
- **Identifying the extinction depth (Section 11.3)**– The optic depth limit for inferring bathymetry (also known as, the extinction depth) is calculated.
- **Applying the bathymetry algorithm (Section 11.3)**– The bathymetry is calculated using the Stumpf et al. (2003) algorithm on the blue and green bands.
- **Vertical referencing (Section 11.4)**– A statistical analysis between the algorithm values to the chart soundings references the Digital Elevation Model (DEM) to the chart datum.

Although a radiometric correction of the imagery band is described in Pe’eri et al (2014), this step will not be described here. The reason is that the quality control on the imagers produced from the currently operational satellite is good enough to provide a bathymetric product and does not require this step anymore. Based on the experience of the authors with different satellite imagery, the blue and green band recommended for SDB are provided in following table:

Table 11.1 Recommended SDB imagery bands from different platforms.

	Blue (range in μm)	Green (range in μm)	IR (range in μm)
Landsat 7	Band 1 (0.45-0.52)	Band 2 (0.52-0.60)	Band 4 (0.77-0.90)
Landsat 8	Band 2 (0.45 - 0.51)	Band 3 (0.53 - 0.59)	Band 6 (1.57 - 1.65)
WorldView2	Band 2 (0.45 – 0.51)	Band 3 (0.51 – 0.58)	Band 8 (0.86 – 1.04)
WorldView3	Band 2 (0.45 - 0.51)	Band 3 (0.51 - 0.58)	Band 8 (0.86 – 1.04)
GeoEye - 1	Band 1 (0.45 – 0.51)	Band 2 (0.51 – 0.58)	Band 4 (0.78 – 0.92)
Ikonos - 2	Band 1 (0.45 – 0.52)	Band 2 (0.51 – 0.60)	Band 4 (0.76 – 0.85)

For more details on satellite-derived bathymetry and hydrographic applications, please refer to the following references:

Pe’eri, S., C. Parrish, C. Azuike, L. Alexander and A. Armstrong, 2014. Satellite Remote Sensing as Reconnaissance Tool for Assessing Nautical Chart Adequacy and Completeness, *Marine Geodesy*, **37(3)**, 293-314.

Stumpf, R., K. Holderied and M. Sinclair, 2003, Determination of water depth with high-resolution satellite imagery over variable bottom types, *Limnology and Oceanography*, **48**, 547-556.

11.1 Pre-processing

11.1.1 Setting up the workspace (ArcMap)

Open ArcMap (either by a double-click on the ArcMap icon or selection from the windows Start/All Programs).

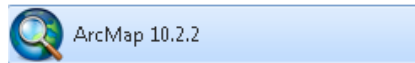

Note: if this is your first time using ArcMap, you will get the following window. Press **OK**.

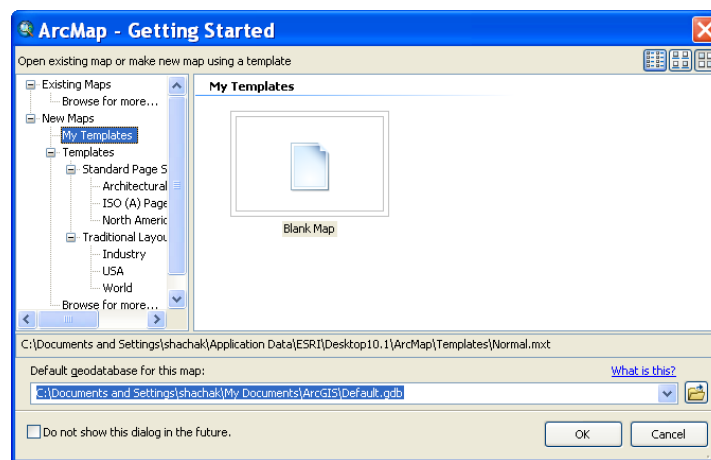

Select **Extensions...** Under the **Customize** Tab.

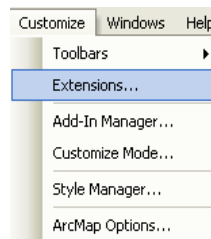

In the **Extensions** window, mark **3D Analyst** and **Spatial Analyst**. Press **Close**.

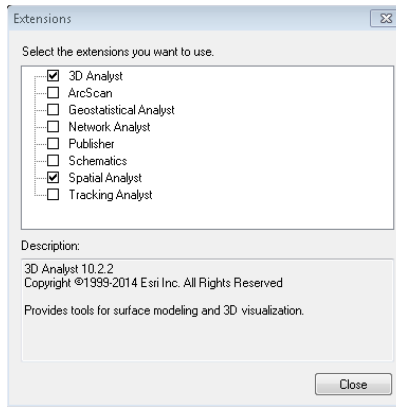

Note: The following steps apply if 3D Analyst is available in your ArcMap license.

Select **Toolbars...** under the **Customize** tab and select **3D Analyst**.

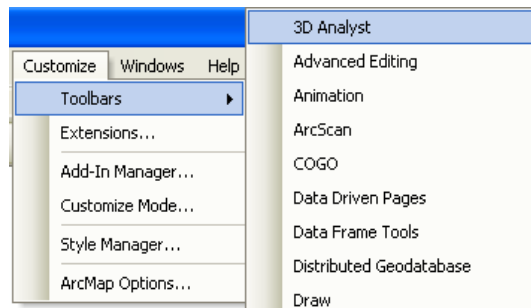

An undocked **3D Analyst** toolbar will appear. Dock it next to the upper toolbars.



Select **Toolbars...** under the **Customize** tab and select **Editor**.

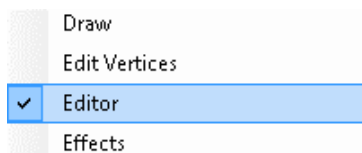

An undocked **Editor** toolbar will appear. Dock it next to the upper toolbars.



Select **Toolbars...** under the **Customize** tab and select **Spatial Analyst**.

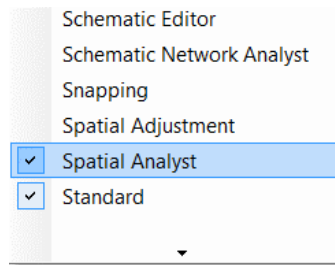

An undocked *Spatial Analyst* toolbar will appear. Dock it next to the upper toolbars.

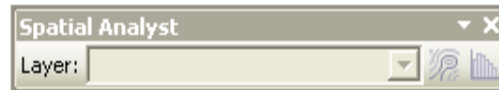

Activate the **Toolbox** by clicking on the icon in the upper toolbar.

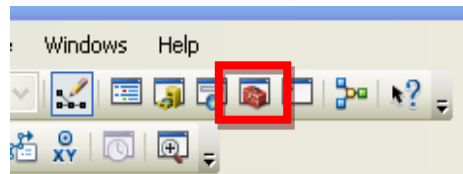

In the main menu, click on **File/Map Document Properties...** Check the box for **Store relative pathnames** to data sources. Click **OK**.

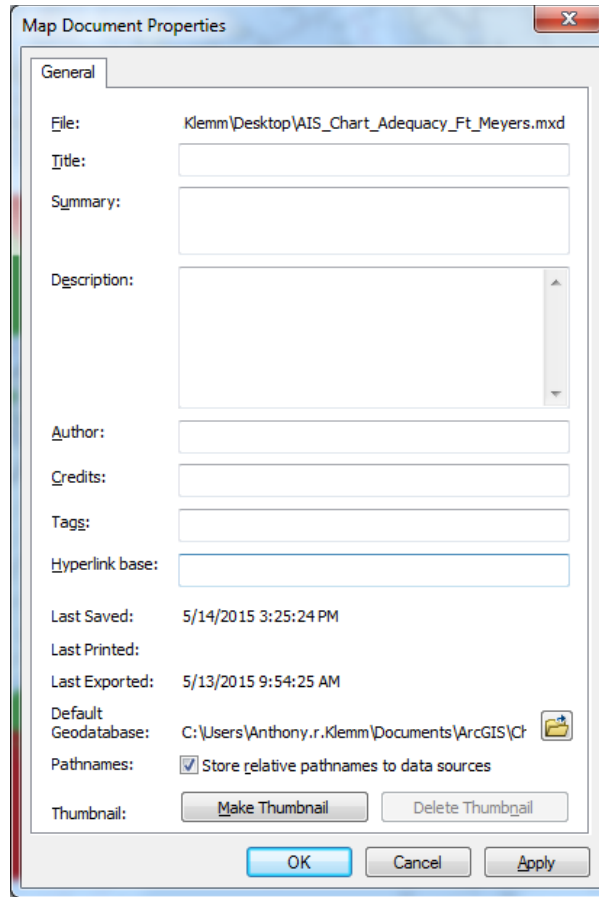

In order to validate that ArcMap is properly executing the command, click on **Geoprocessing/Geoprocessing Options...** in the main menu.

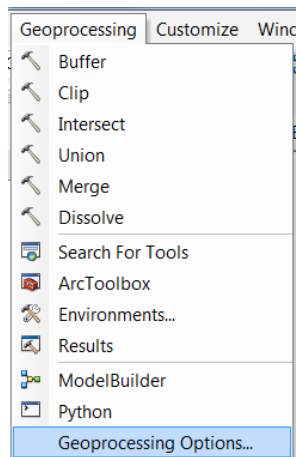

In **Geoprocessing Options** window, uncheck the **Enable** box under **Background processing** and press **OK**.

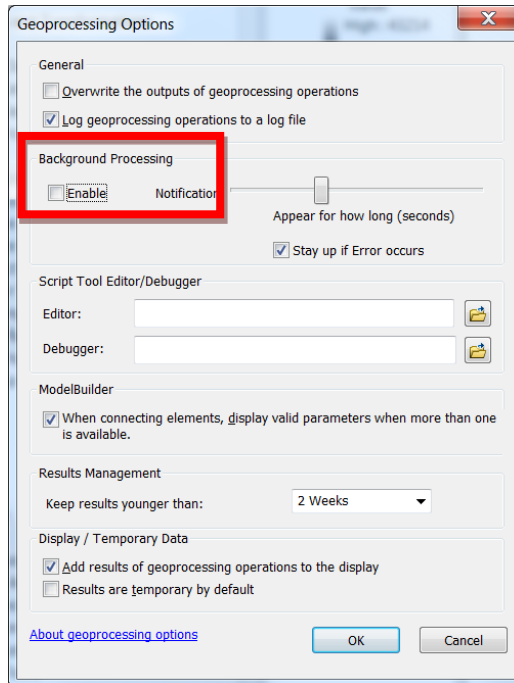

Activate the **Catalog** by clicking on the icon in the upper toolbar.



Navigate in the **Catalog** window, and create a **New Folder Connection**. Click on the **New Folder Connection** button in the Catalog toolbar and select the folder in the directory where your data is located. (e.g. C:\working).

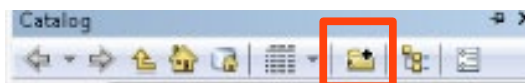

Navigate in the **Catalog** window into the desired directory, right-click and select **New/File Geodatabase**.

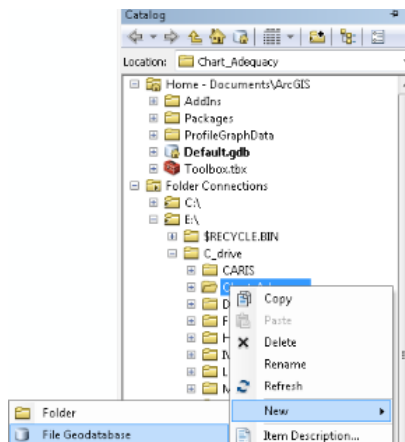

Right-click on the new Geodatabase and select **Rename**.

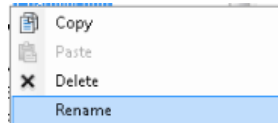

Change the name of the Geodatabase to the chart's name/number and press **Enter**.

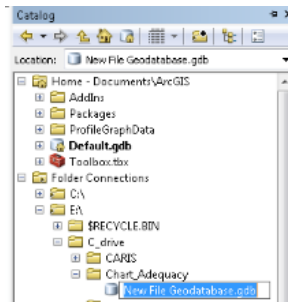

Right-click on the new Geodatabase again and select **Make Default Geodatabase**.



The new Geodatabase will be recognized as default (marked bold).

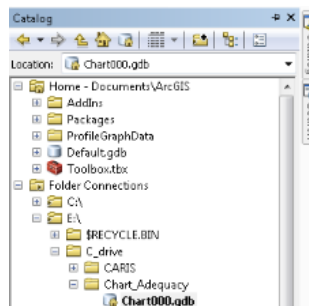

Save your project in the Site project directory by selecting **File/ Save As...**

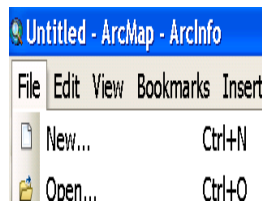

Make sure to save the MXD using the naming convention <Site>_<project/date>.

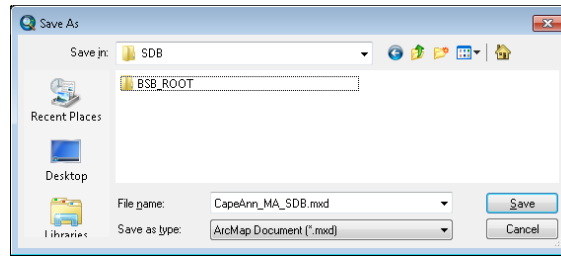

11.1.2 Importing an Raster Navigation Charts (RNC) into the project

Downloading a NOAA chart

Using a web browser, navigate to NOAA's interactive catalog:

<http://www.charts.noaa.gov/InteractiveCatalog/nrnc.shtml>.



Zoom into the region being examined and click on the chart polygon in the desired area. Make sure that the chart you are interested is selected (right side of the screen), and click on **Download RNC in BSB format**.

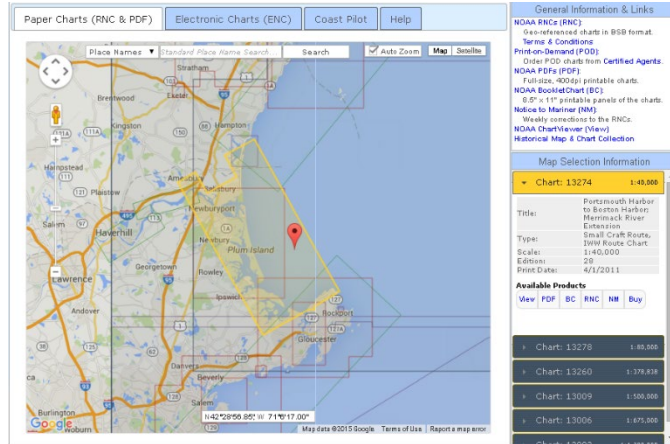

Note: The chart is downloaded in a compress format. Make sure to unzip the chart to your data directory.

Adding the RNC into the project

In the main menu, load the RNC data to ArcMap by right-clicking on the desired directory and select *Add Data...*



Navigate to the directory containing the raster charts, select your chart and press **OK**.

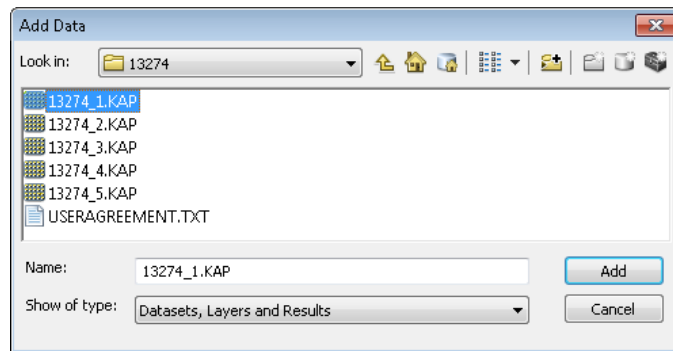

Note: The raster chart format may vary between hydrographic offices (e.g., GeoTiff, KAP, etc.)

You may be asked to create pyramids for the scanned chart. Press **Yes**.

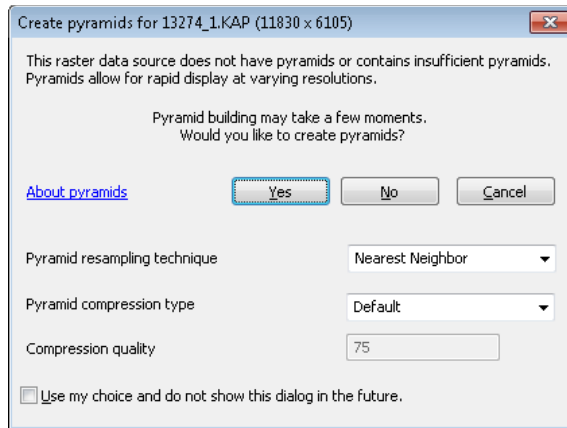

Right-click on **Layers** in the **Table of Contents** window and select **Properties...**

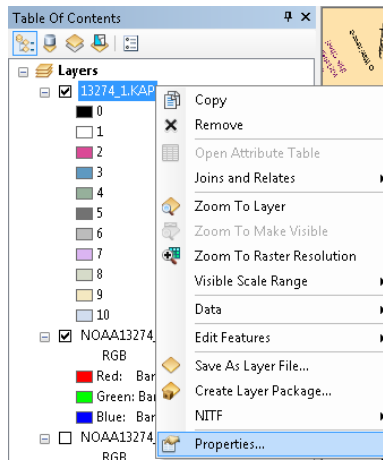

In the **Layer Properties**, scroll down under Property to see the **Spatial Reference** (in this example Global Mercator (degree units) using a WGS-84 datum). Press **OK**.

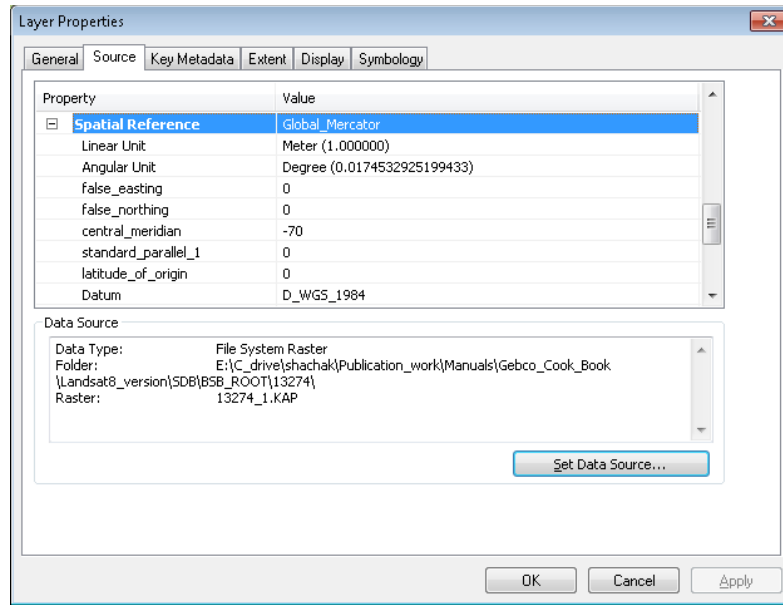

Referencing a chart

Note: Make sure to acquire copyright permission from the hydrographic organization that produced the chart before scanning a chart.

Load the scanned chart image to ArcMap by selecting the **Add Data...** icon.



Navigate to your directory and select the chart in the **Add Data** window and select **Add** button.

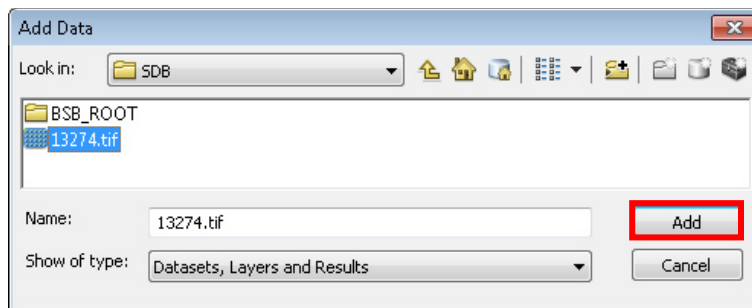

You may be asked to create pyramids for the scanned chart. Press **Yes**.

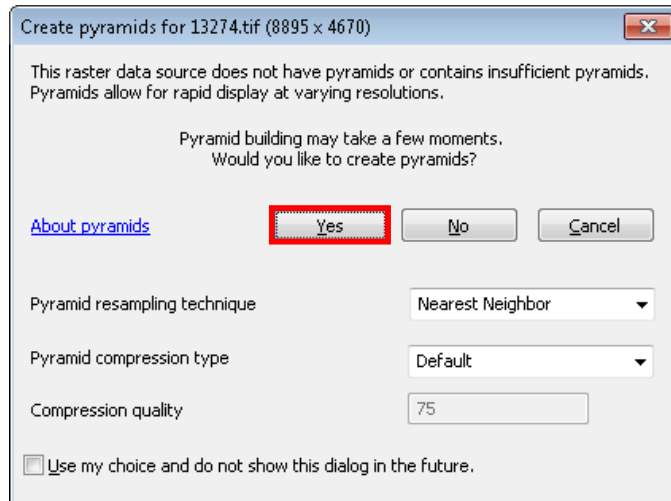

You will also receive an **Unknown Spatial Reference** warning that this image is not referenced. Confirm this message by pressing on **OK**.

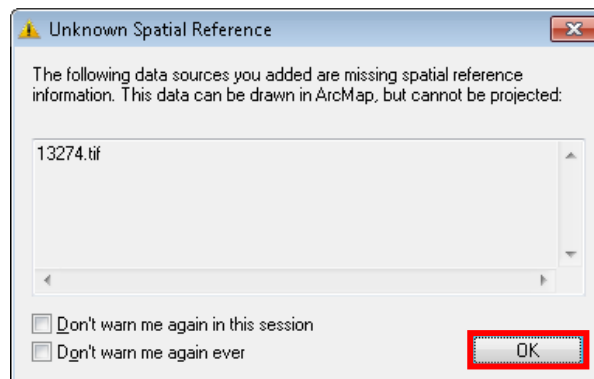

Your chart is now loaded into ArcMap

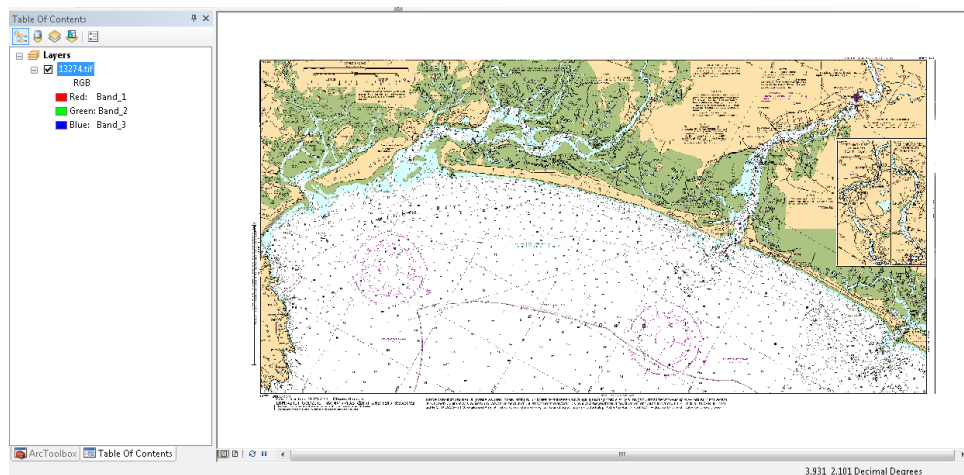

Select the **Zoom In** (magnify) icon



Zoom in to location that the longitude and latitude graticules intersect. Make a list of at least four intersection points (note: recommended number of intersection points is nine) around the chart with their corresponding arbitrary geographic coordinates. In this example the Source Control Points are X: 2.352° and Y: 1.217° and the Target Control points are X: -70.6333° and Y: 42.7° (long.: 70°38'W and lat.: 42°42'N).

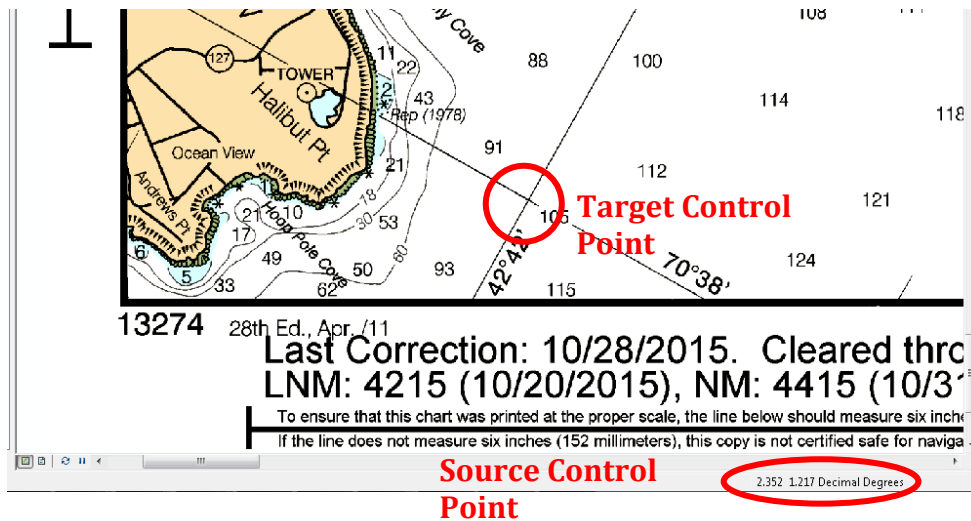

Note: Make sure to identify the horizontal reference system used for the chart for later use (in this example, WGS-84).

Select **Data Management Tools / Projections and Transformations / Raster / Warp** in the **Toolbox** window.

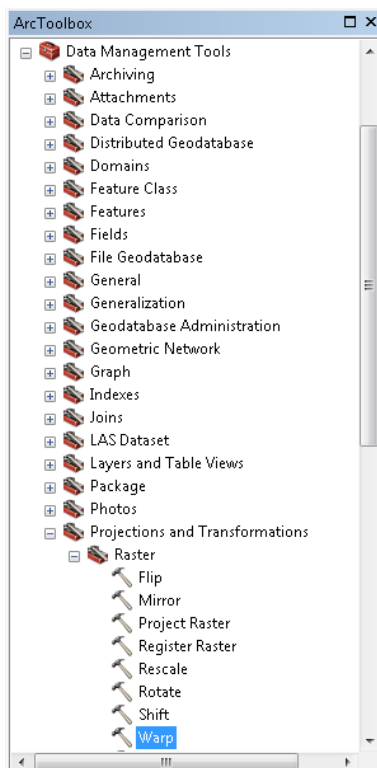

Load the input raster (i.e., the scanned chart) as **Input Raster** in the **Warp** window. Add the Source and Target control points (make sure that the order of the control point is the same in both lists). Validate that the **Transformation Type: POLYORDER1** and press **OK**.

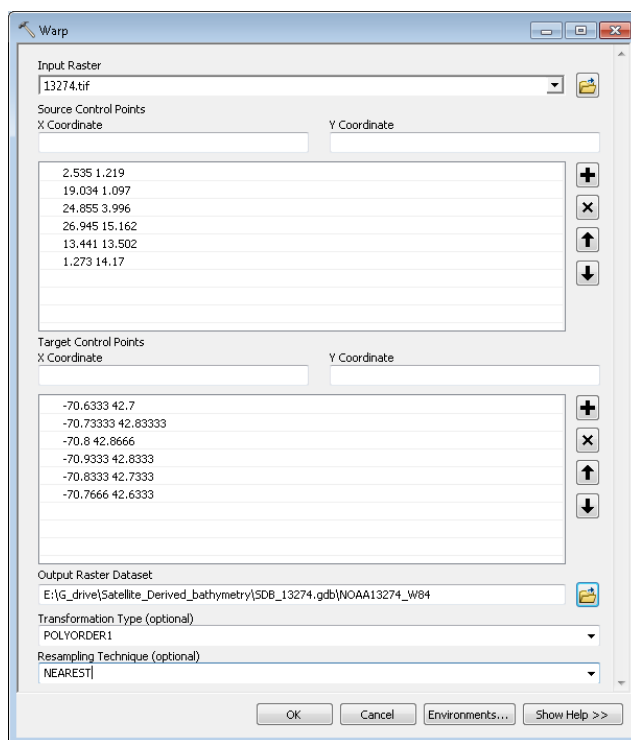

The raster chart is now oriented correctly. However, does not currently contain a horizontal reference system.

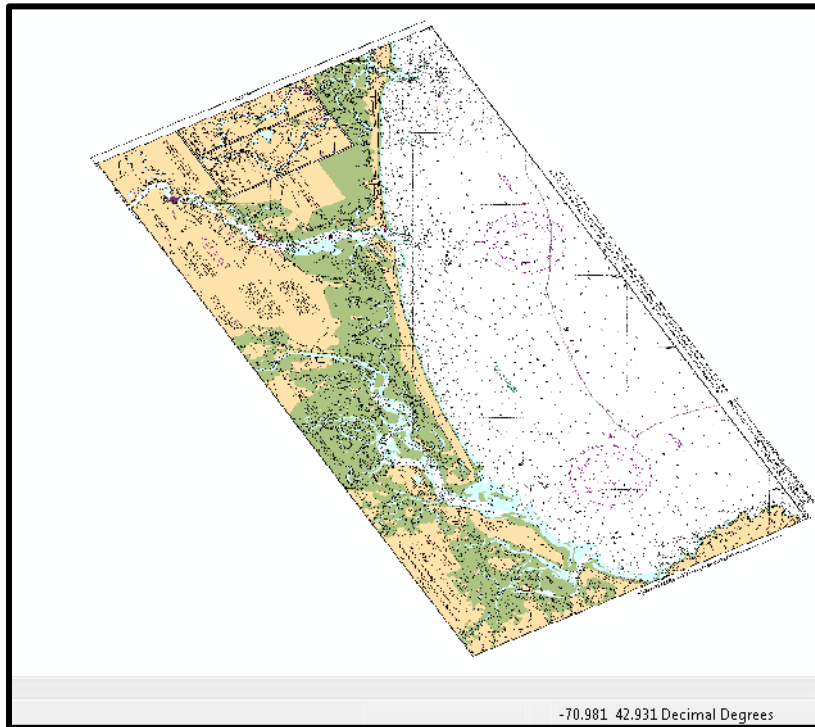

Select ***Data Management Tools / Projections and Transformations / Define Projection*** in the **Toolbox** window.

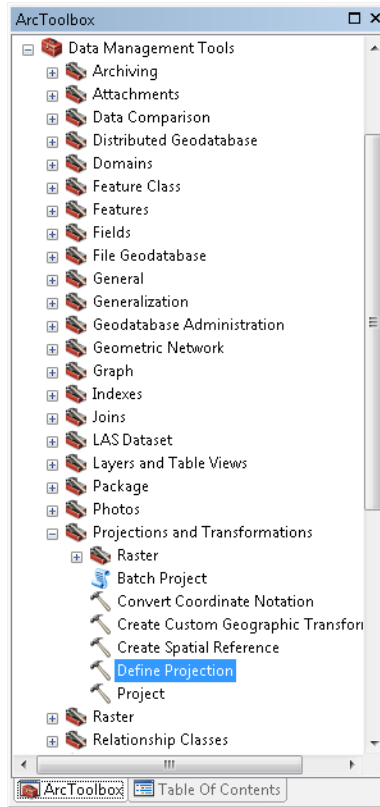

Load the warped image into the **Project Raster** window and press the **Select Reference Properties** icon. Select the proper geographic reference system (in this example, the reference system is *Geographic Coordinate System/World/WGS84.prj*). After selecting a reference system, press **OK**.

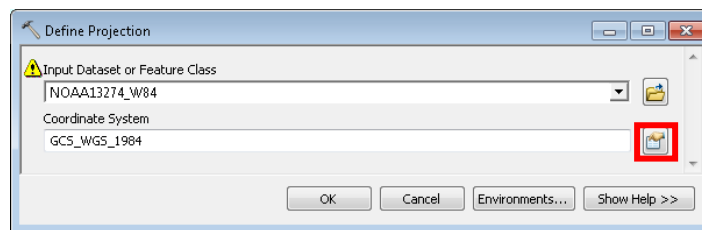

11.1.3 Control points

Note: There are many format that control points can be provided. Below we show three examples: 1) ASCII point cloud, 2) S-57 attribute from an ENC (SOUNDG), 3) digitize soundings.

ASCII point cloud

Note: A recommended ASCII format to import point into ArcMap is Comma Delimited (*.csv).

Using a text editor it is possible to verify that the ASCII file contains three columns (easting/longitude, northing/latitude, and depth). In this example, the sounding are provided geographic coordinates using a WGS-84 ellipsoid).

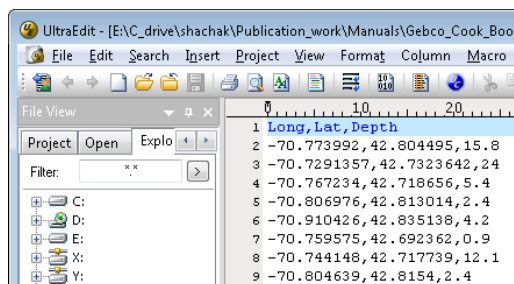

Load the ASCII point file into ArcMap by selecting **Add Data...** The data was added as a table and is only present under the **Source** tab in the **Layers** window.



Right-click on the ASCII point file in the **Layers** window, and select **Display XY Data** (for creating an event layer).

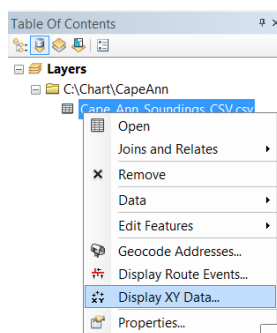

In the **Display XY Data** window, select Longitude (“**Long**”) as the **X field**, Latitude field (“**Lat**”) as the **Y field** and **Depth** as the **Z field**. Press the **Edit...** button to define a coordinate system. Press **OK**.

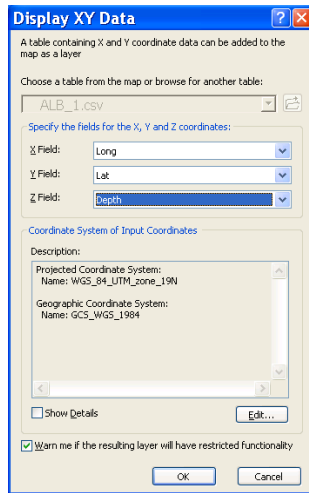

Note: If you get the following message, press OK. This message brings to your attention that there is one or more fields that are not X field or Y-field and can be used as Z-field.

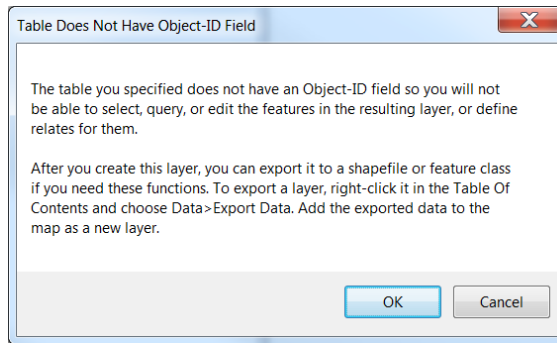

Your display should look like the following:

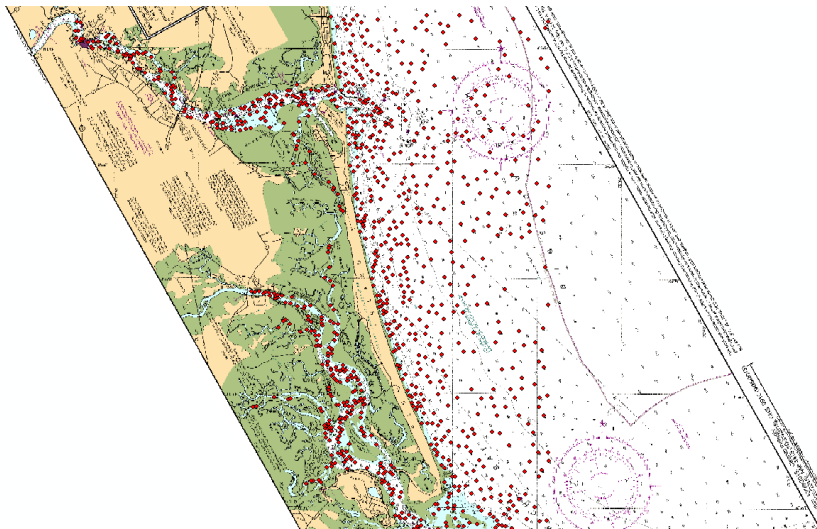

SOUNDG S-57 Attribute

Note: Make sure that you have installed ESRI's S-57 reader:
(<http://www.esri.com/software/arcgis/extensions/esri-s57/download>).

Navigate to the directory containing the ENC files, select **SOUNDG** file from the ENC file and press **Add**.

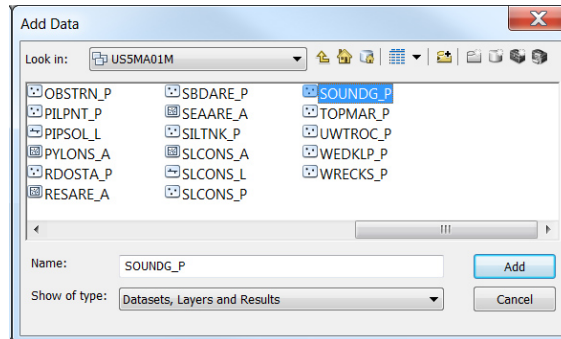

In **ArcCatalog**, select the file geodatabase in the Data directory folder. Create a new feature class, right-click the geodatabase and select **New** then **Feature Class**.

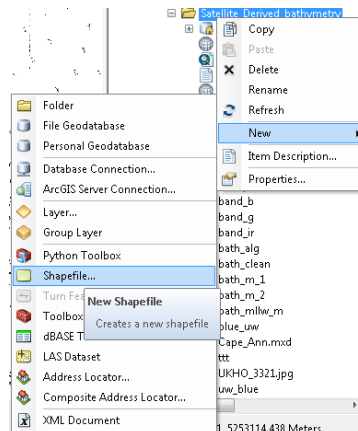

In the Create New Shapefile window, name the file (“Control_points” in this example), select **Point** as the feature type. Click **Next**.

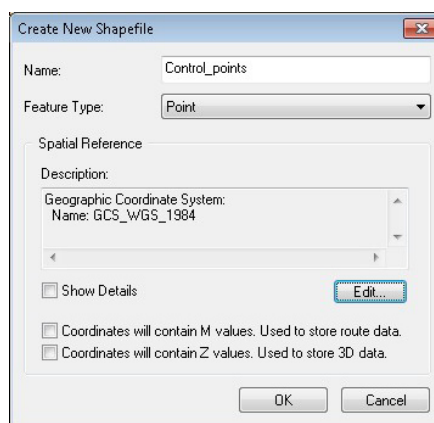

The control point layer will appear in the **Table of Contents** window. Right-click on the *Control_points* layer and select **Open Attribute Table...** in the **Table Of Contents** window.

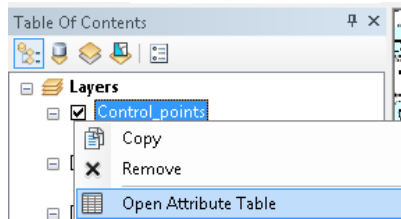

The In the **Table** window, click **Table Options > Add Field...**

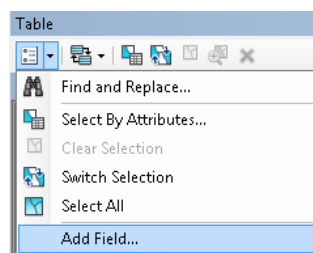

In the **Add Field** window, type: Name: **Depth_m**, select Type: **Float** and press **OK**.

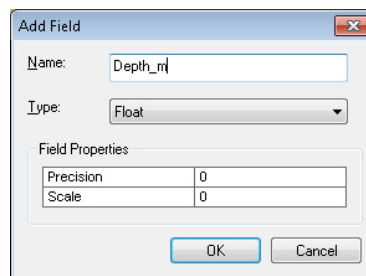

In the **Table of Contents** window, right-click on the control point file and select **Edit Features** then **Start Editing**.

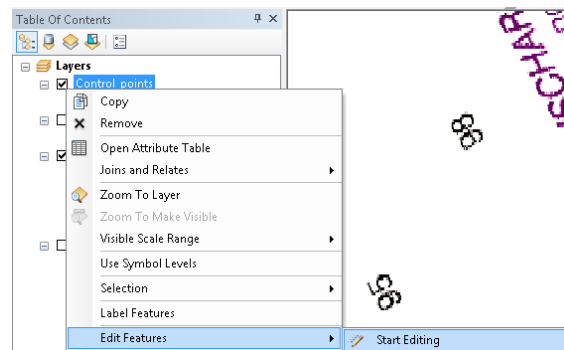

You may get the following message, press **Continue**.

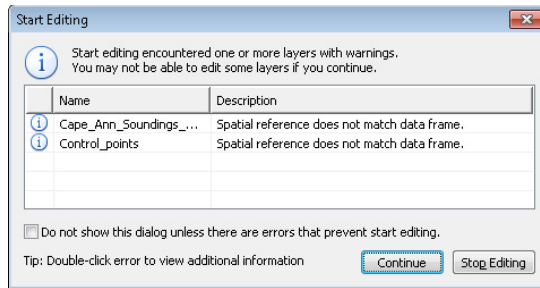

Note: In case the **Create Features** window does not appear automatically, select the **Create Features** icon from the **Editor** toolbar.



Select the **Control_points** layer in the **Create Features** window and select **Point** under **Construction Tools**.

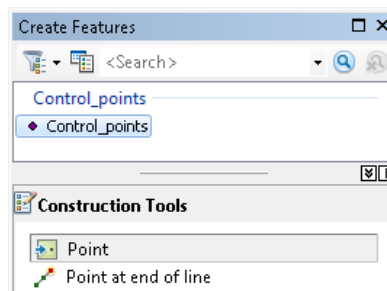

Left-click on the sounding with same depth value (in this example 1 ft soundings).

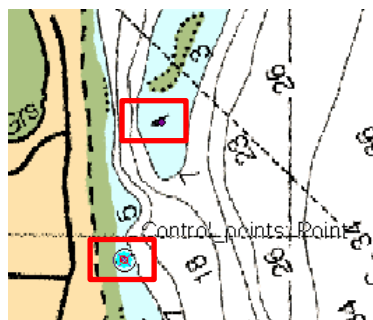

In the **Editor** toolbar, select **Save Edits** and then select **Stop Editing**.

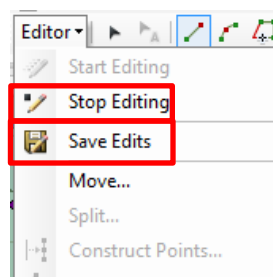

In the **Table of Contents** window, right-click again on the control point file and select **Edit Features** then **Start Editing**.

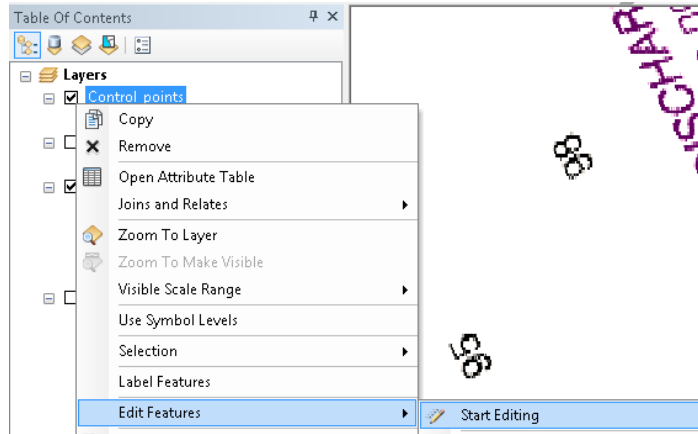

Type the depth value in m under the Depth_m column.

The screenshot shows the attribute table for the 'Control_points' layer. The table has four columns: FID, Shape *, Id, and Depth_m. The first row has FID 0, Shape * Point, Id 0, and Depth_m 0.3. The second row has FID 1, Shape * Point, Id 0, and Depth_m 0.

FID	Shape *	Id	Depth_m
0	Point	0	0.3
1	Point	0	0

In the **Editor** toolbar, select **Save Edits** and then select **Stop Editing**.

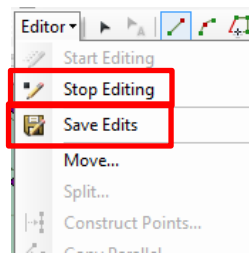

Repeat sampling the sounding (the last eight steps) for every depth groups (updating the table accordingly).

11.1.4 Satellite layers (Landsat)

Open a Web Browser and go to . Login into your account (the Login button is upper right corner of the window).

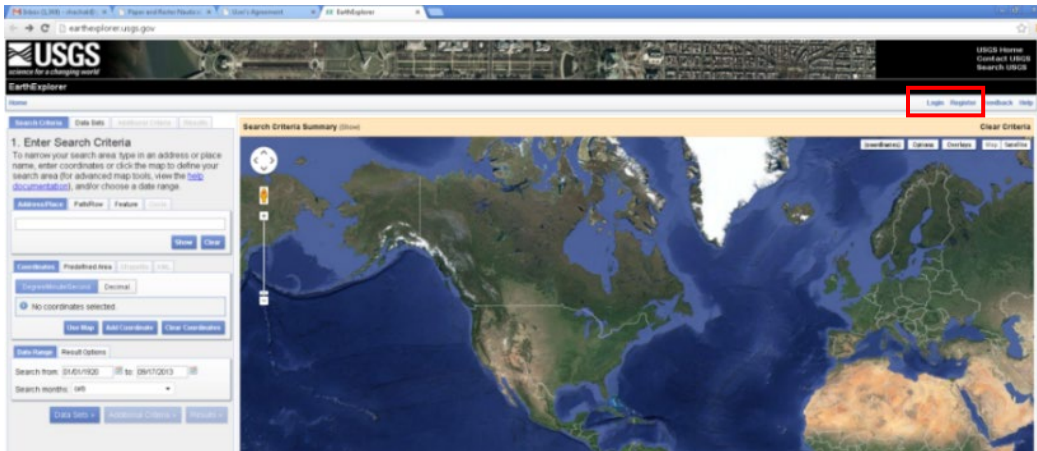

Note: The service is free, but the website requires user to login. Users that are accessing this site for first time need to register (the **Register** button is upper right corner of the window).

Zoom into the desired region. Create a square around the desired region by clicking on the corners of the area. The polygon vertex coordinates will appear in the Search Criteria tab.

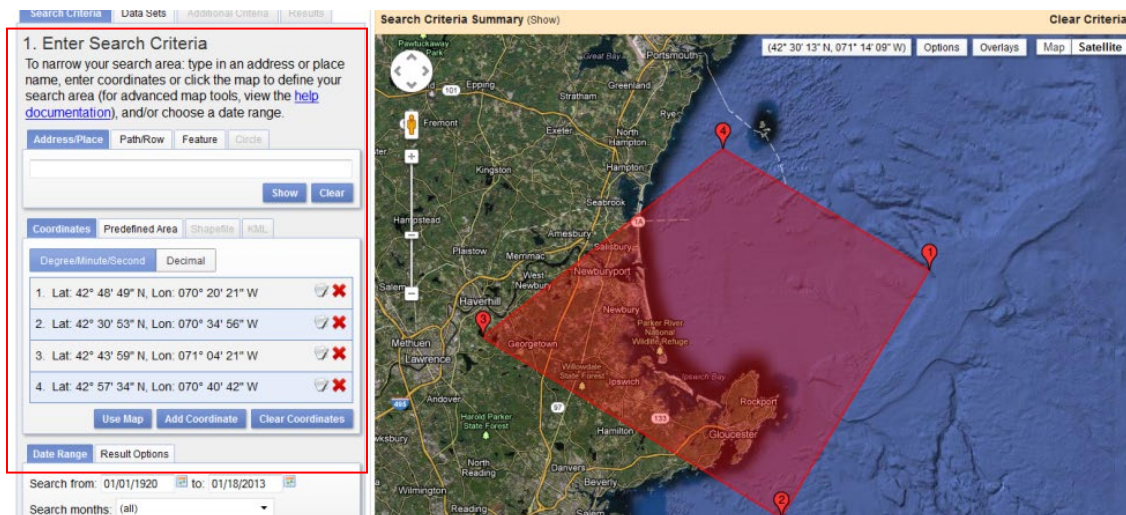

Alternatively, type in a location you are interested in and the country in the **Address/Place** located under the **Search Criteria** tab and click on **Show**. Select the site of interest from the list of possible sites with similar names and the location will be shown on the map.

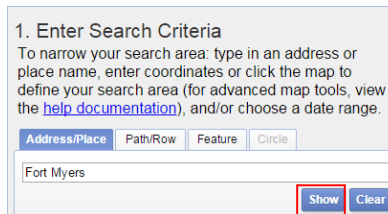

On the top left side of the screen, click on the **Data Sets** tab.

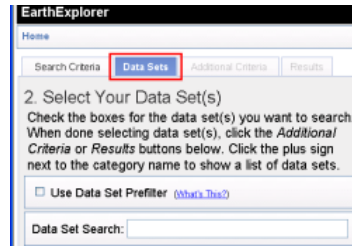

Expand the **Landsat Archive** and select **L8 OLI/TIRS** for Landsat8 imagery and click OK then click Results.

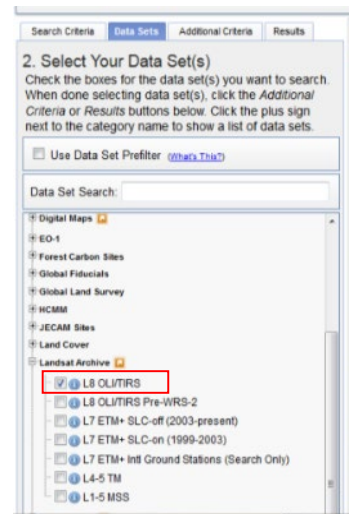

Select the **Results** tab.

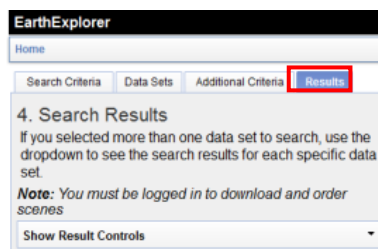

Scroll down and look at the quick view results. Select the download icon of the desired data set.

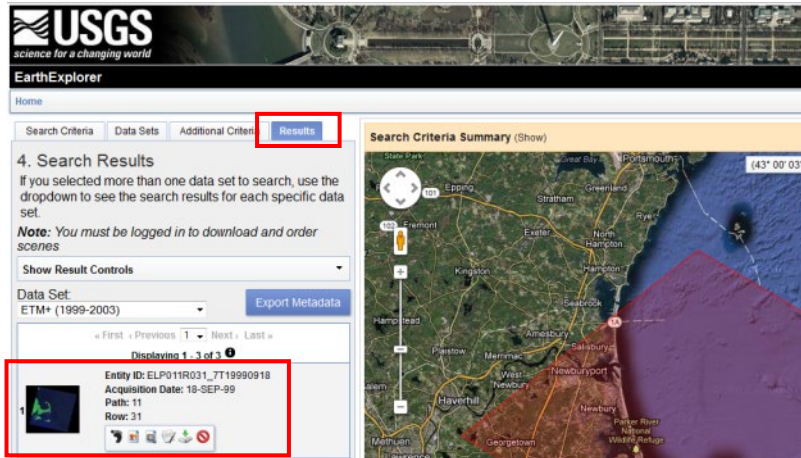

Before selecting the image, it is possible to preview the image by clicking on **Show Browse Overlay**.

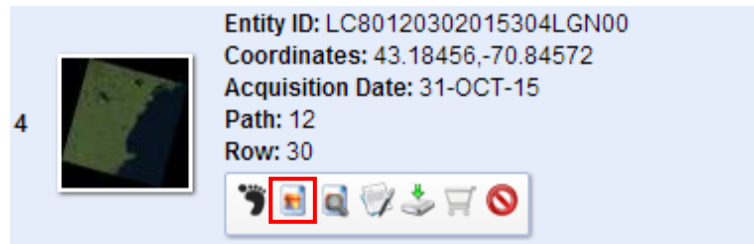

Select **Download** to display the area you are interested to process.

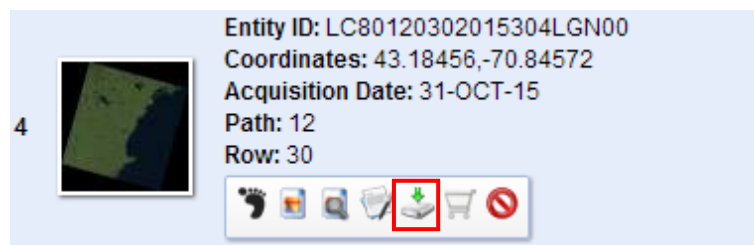

Select **Level 1 GeoTiff Data Product** and press **Download** in the **Download Options** window.

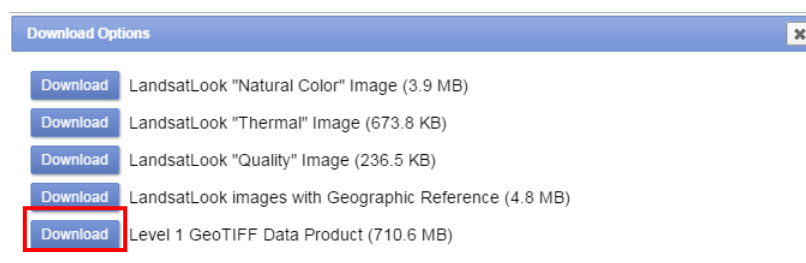

Extract your *.zip file into your local directory.

Note: The bands of Landsat imagery are typically download as separate imagery files in *.Tif format and not as a single multi-band image (e.g., WV-2).

Note: In case that disk space is an issue, delete the *.zip file and bands B7 to B11.

Load the satellite data to ArcMap by selecting **Add Data...** in the main menu.



Navigate to your directory and select the satellite images in the **Add Data** window and select **Add**. The Blue, Green and Infrared bands in Landsat 8 are numbers as: *_B2.tif, *_B3.tif, and *_B6.tif, respectively.

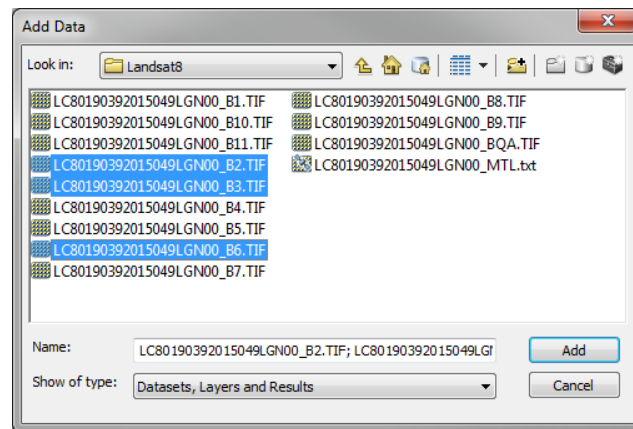

Note: If your imagery is not on your computer, you will need to use the **Connect to Directory** in order to link your project to your computer.



In case you are asked to create pyramids, press **Yes** for each image you open.

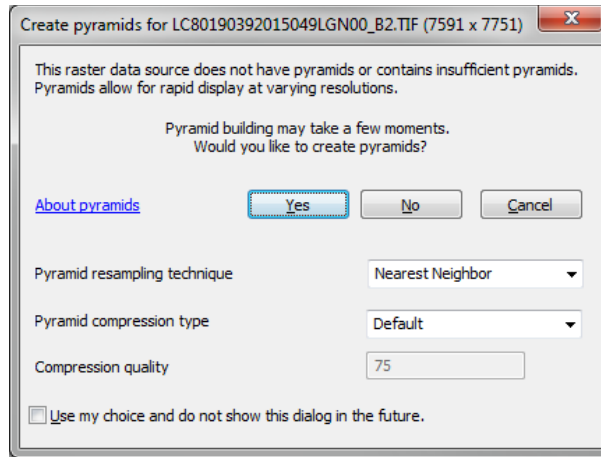

The satellite imagery will be loaded with black background (typically, background pixel value is 0).

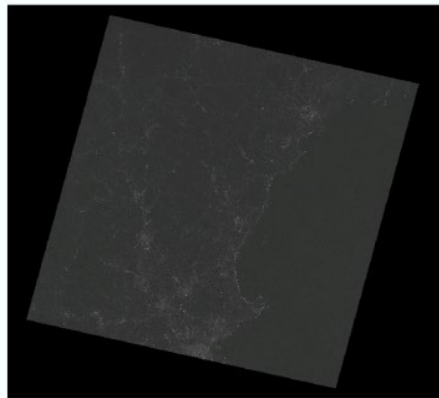

Right click on the image layer and select the **Properties...** button.

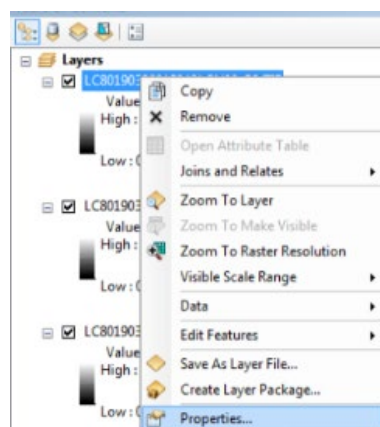

In the **Symbology** tab, check the **Display Background Value** box (in this case black is when the value is 0).

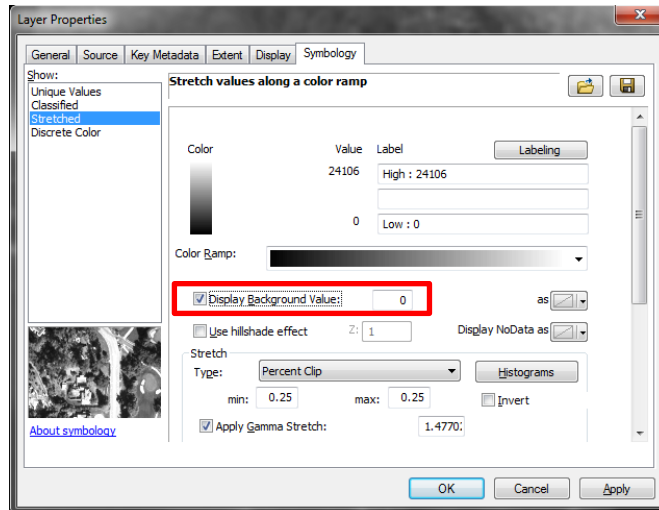

Press the **Apply** button and then the **OK** button in the Layer Properties window. Now the layer is without the black background. Repeat steps to remove background for the other layers.

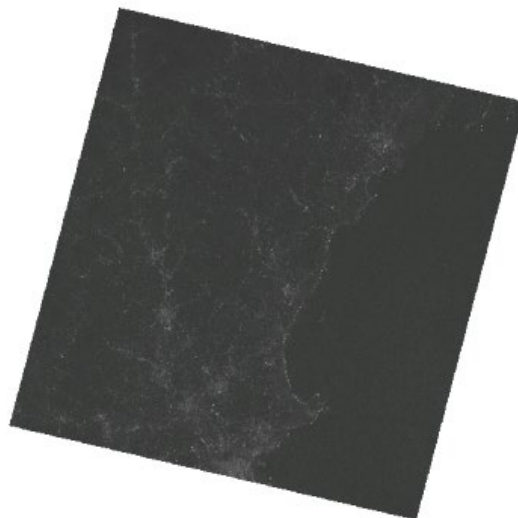

Save the project by selecting **File/Save** in the main menu.

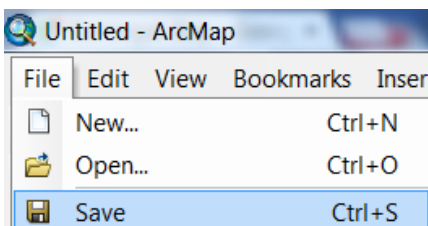

11.2 Land/water separation

Note: There are several ways to calculate a threshold value for land/water separation. Two common options are: 1) **Profile**, and 2) **Identify**. A recommended approach is using the profile

option, however this approach requires **3D Analyst** (not all users have this option under their current ArcMap license).

11.2.1 Identifying the threshold values

Option 1: Profile using 3D Analyst (if available)

In the 3D Analyst toolbar, select the infrared band (*_B6.tif in Landsat 8).



Press the **Interpolate Line** icon in the **3D Analyst** toolbar.



Make sure that the infrared band is visible in the project. Using the left button, draw a line that crosses from land (bright areas) into the water (dark areas). Finalize the line by double-clicking the left button.

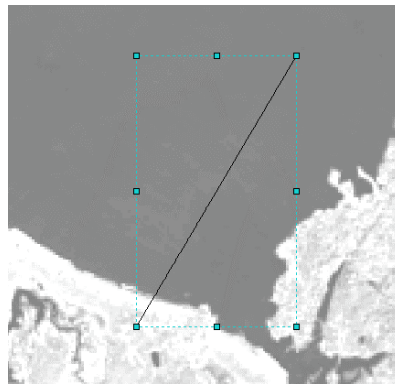

After drawing the line the **Profile Graph** icon in the **3D Analyst** toolbar will be active. Press the **Profile Graph** icon.



The result will be a plot that can be used to extract the land/water threshold. The smooth section with low values represents water, whereas the fluctuation high value areas represent land. In this case, the threshold value is around 5750, above the highest pixel values of the water.

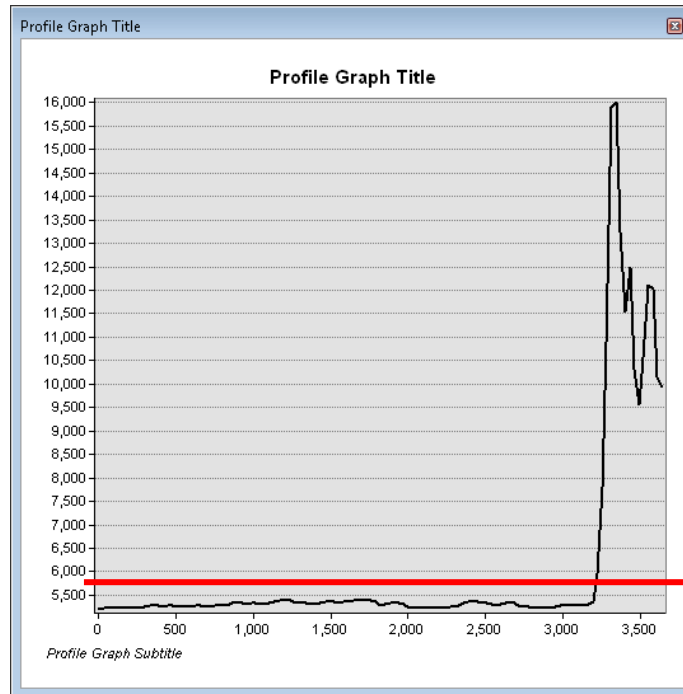

Option 2: Identify function

Activate only the infrared band (*_B6.tif in Landsat 8).

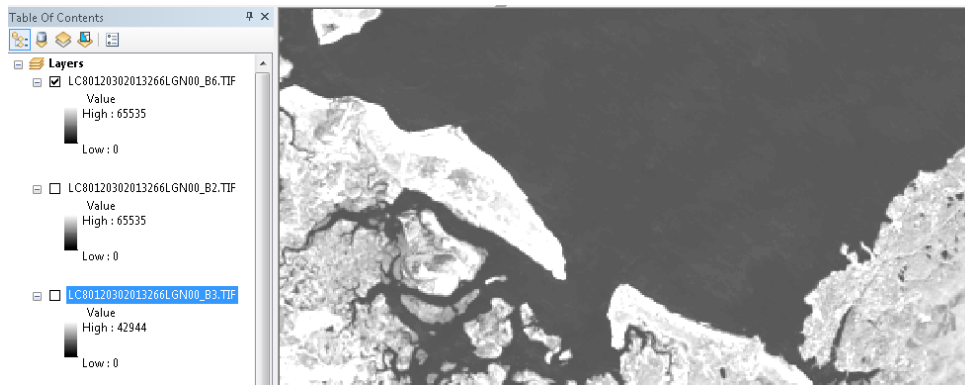

Select the *Identify* icon



Click on several locations over the water and write down the values. Then, click on several locations over the land and write down the values. The threshold value should be between the water values and the land values (note: make sure you write down the **Pixel Value**).

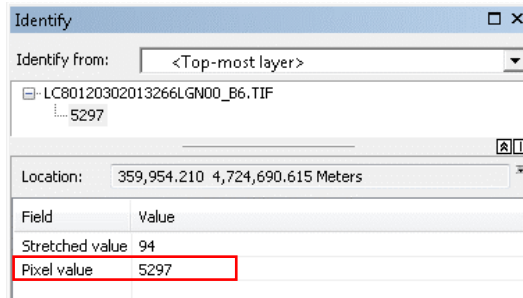

11.2.2 Water body extraction

Select *Spatial Analyst Tools / Math / Float* from the toolbox.

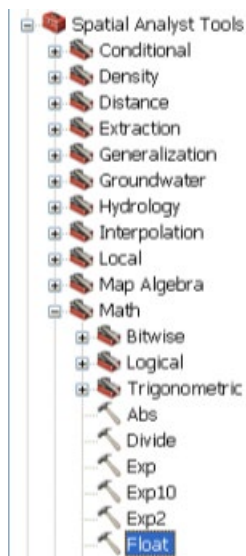

In the **Float** window, select the infrared band *_B6.tif in Landsat 8) and type in an output raster. Press **OK**.

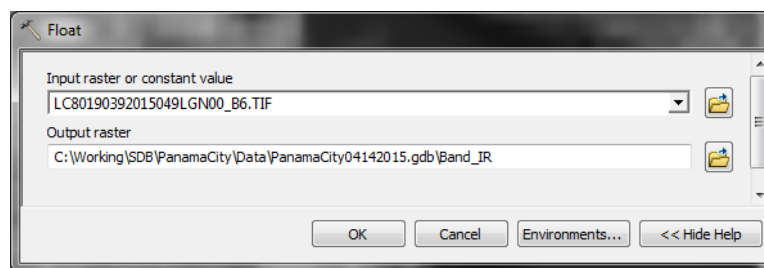

Repeat this step also for the blue *_B2.tif in Landsat 8) and the green *_B3.tif in Landsat 8) bands.

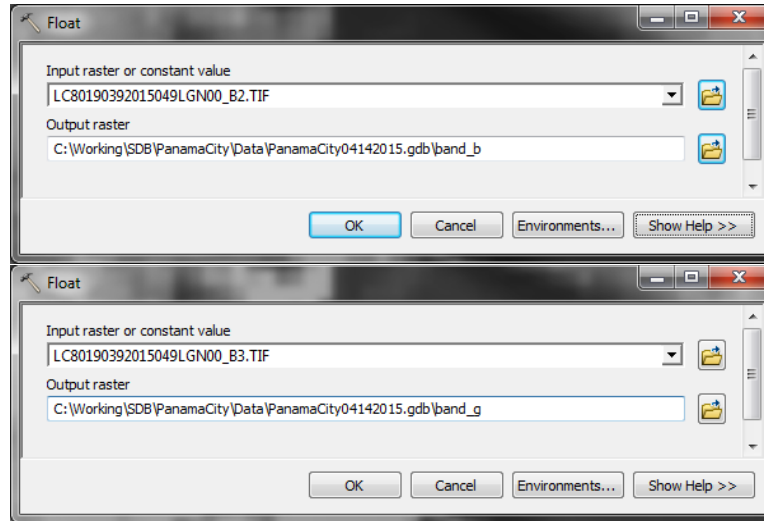

Next, apply a low pass filter (LPF) by selecting *Spatial Analyst Tools / Neighborhood / Filter*

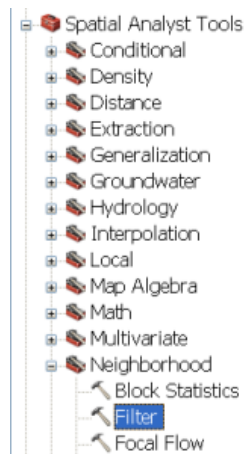

In the **Filter** window, select the infrared band in float format. Also, make sure that the **Filter type (optional)** is **LOW**. Press **OK**.

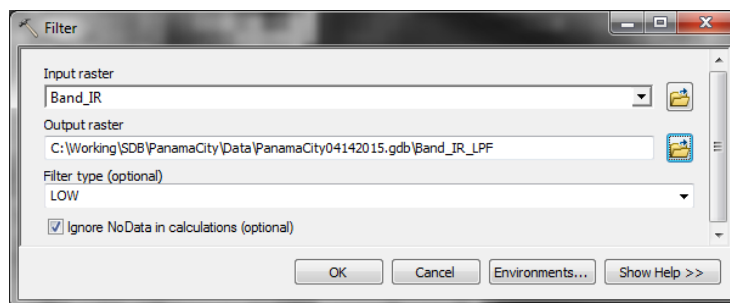

Repeat this step also for the blue and green float files.

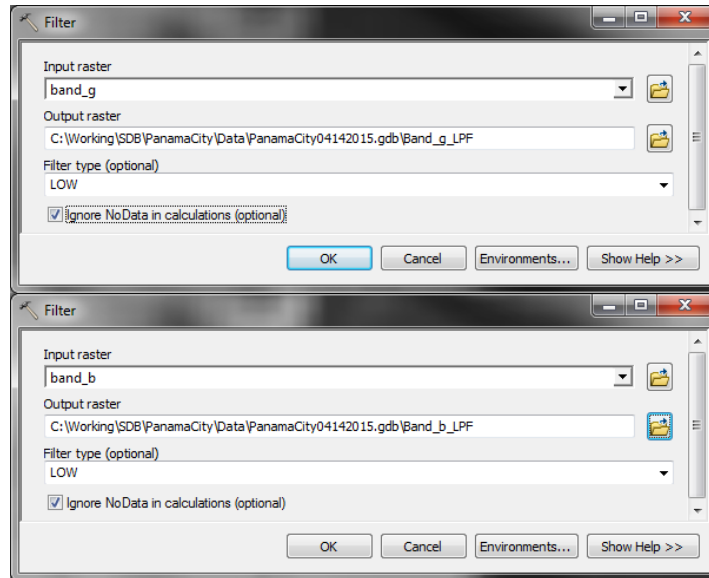

Remove the land from the blue and green imagery, by selecting **Spatial analyst Tools/Conditional/Set Null** in the **Toolbox** window.

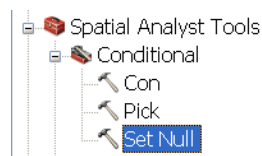

Fill the **Set Null** window as follows for the blue band and press **OK**. Make sure that the threshold value in the expression is the value calculated from the IR band.

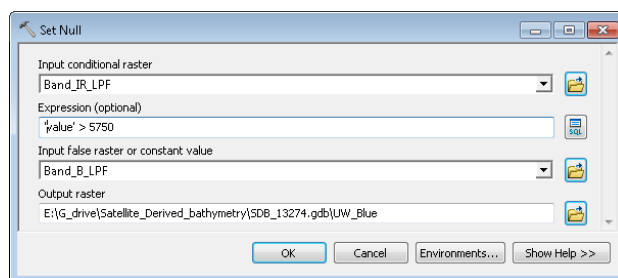

Repeat this step also for the green band.

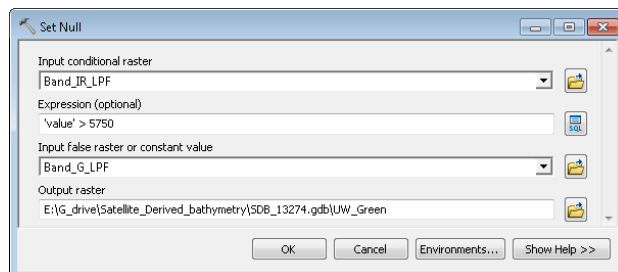

Note: The new green and blue layer should contain areas only water body areas.

11.3 Applying the SDB algorithm and calculating extinction depth

11.3.1 Applying the SDB algorithm

Select *Spatial analyst Tools / Map Algebra / Raster Calculator* in the **Toolbox** window.

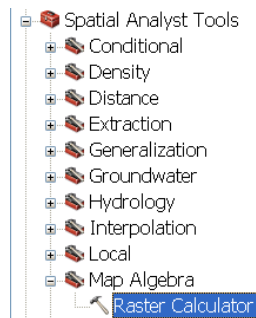

In the Raster Calculator window, write the following command: $\text{Ln} ("UW_blue") / \text{Ln} ("UW_green")$. Name the **Output Raster: Bath_alg**.

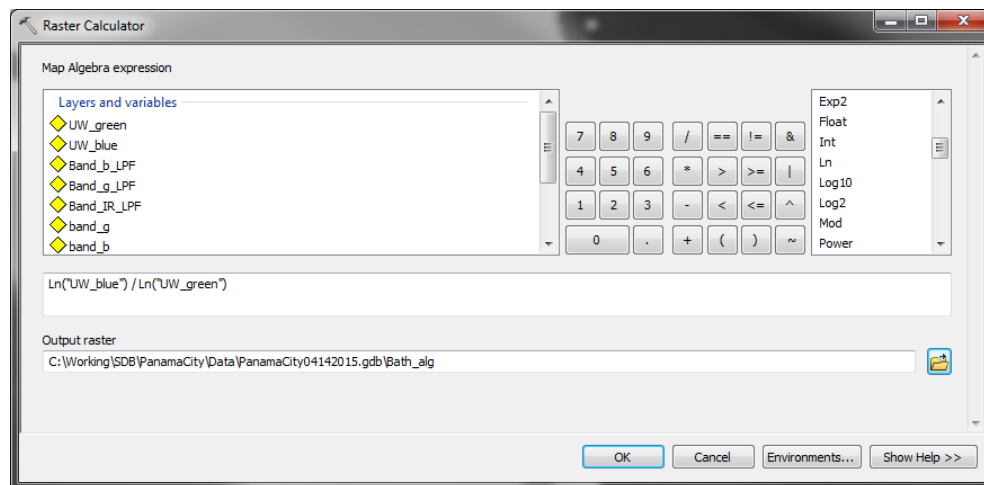

For visual inspection, right-click on the “**Bath_alg**” layer from the **Table of Contents** and select *properties*.

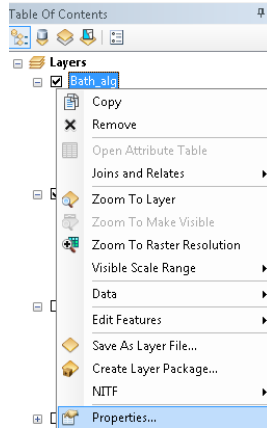

In the **Layer Properties** window under the **Symbology** tab, set the color ramp **Stretch: Standard Deviations** as follows and press **OK**.

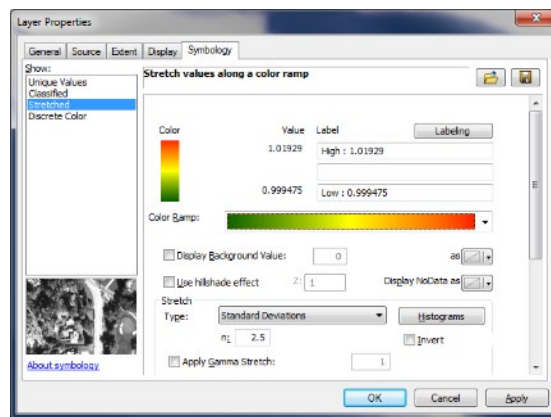

In the **Table of Contents**, drag the chart layer above the Bath_alg layer. It is now possible to compare the algorithm results with the chart.

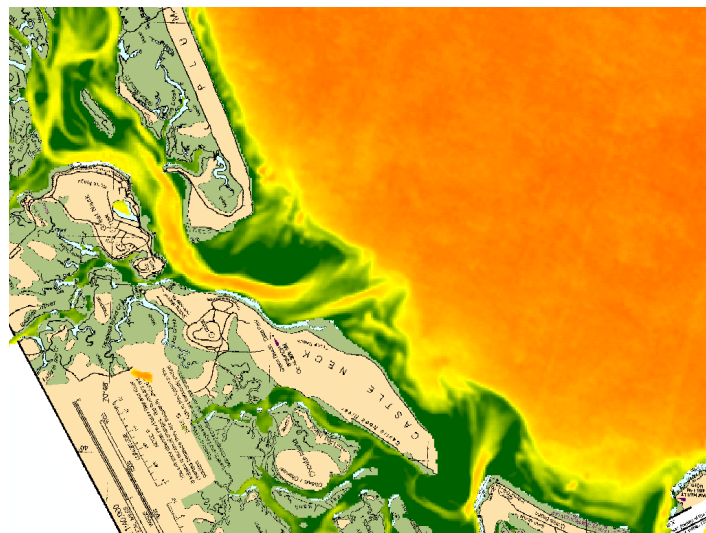

Save the project by selecting **File/Save** in the main menu.

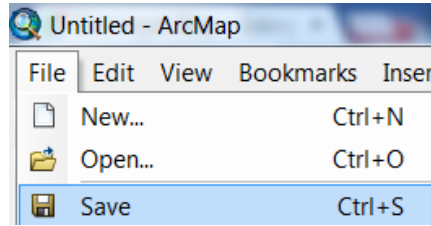

11.3.2 *Depth of extinction calculation*

Select **Data Management Tool / Projection and Transformations / Project** to convert the control points from geographic coordinates into a UTM projection (the zone will differ with location).

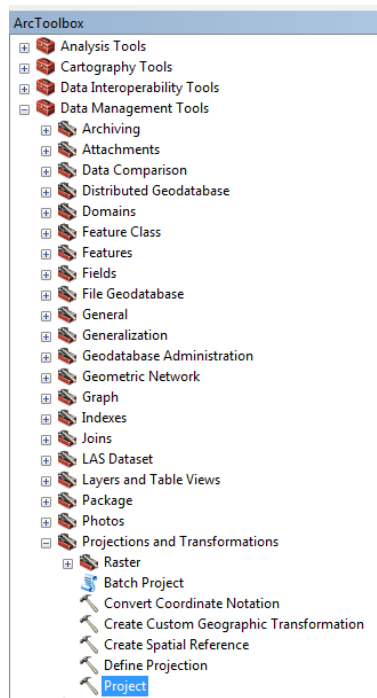

In the **Project** window, Type "**Control_points_UTM**" as the Output Feature Class and select the Output Coordinate Systems as: **WGS_1984_UTM_zone_19N** for this example.

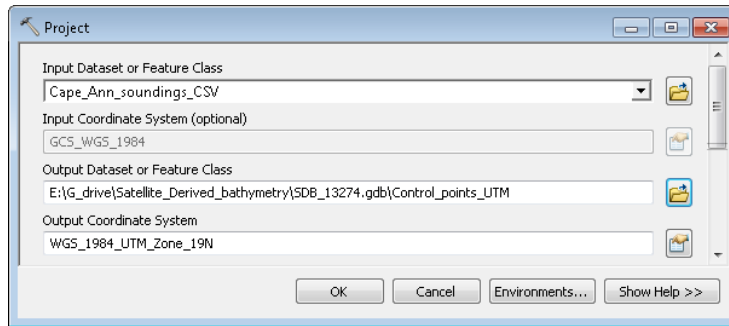

Note: The input Dataset name will vary according to the method you created your control point dataset.

Note: In order to NOT select soundings over “false bathymetry” caused by sediment turbulence, a polygon will be created based on a visual inspection of the algorithm layer.

Right-click again on the “**Bath_alg**” layer from the **Table of Contents** and select *properties*.

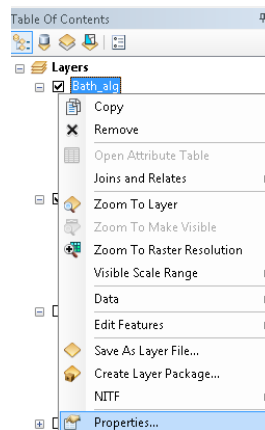

In the **Layer Properties** window under the **Display** tab, set the **Transparency: 50%** as follows and press **OK**.

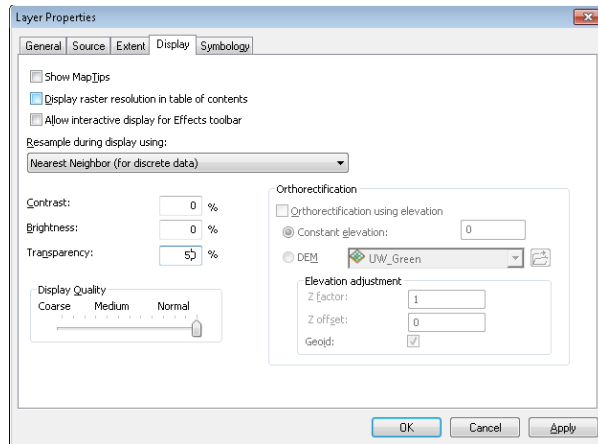

Make sure that you see the control points over the SDB algorithm.

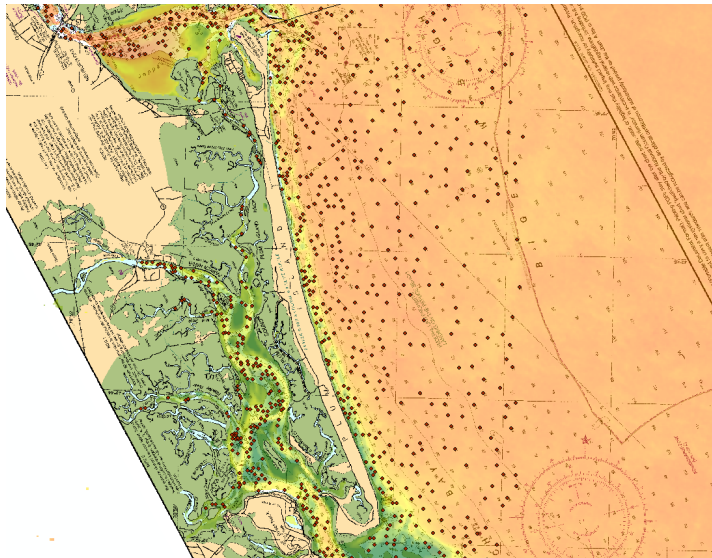

In **ArcCatalog**, select the file geodatabase in the Data directory folder. Create a new feature class, right-click the geodatabase and select **New** then **Feature Class**.

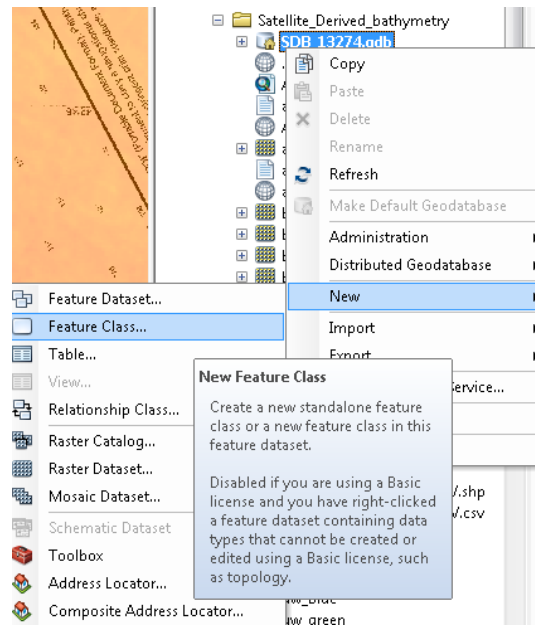

Name the file "ref_mask", select **Polygon Features** as the feature type. Click **Next**.

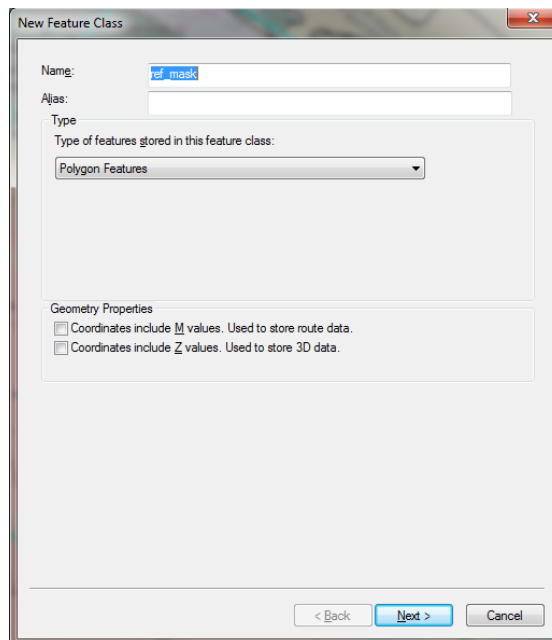

Select a coordinate system from the **Layers** dropdown. Click **Next** three more times and then click **Finish**.

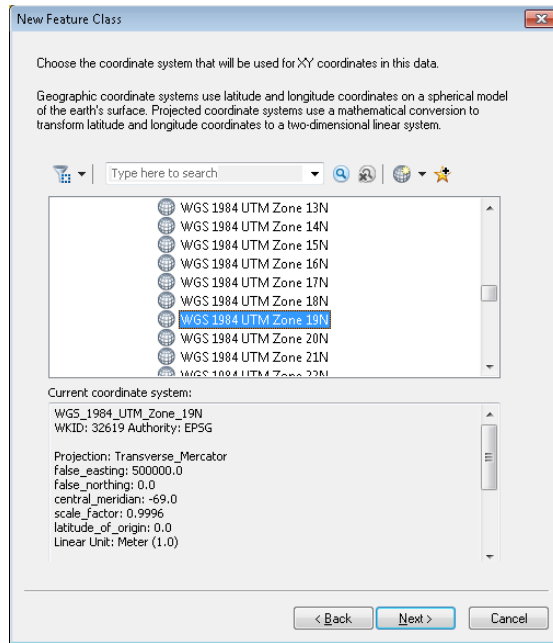

Right-click the `ref_mask` layer and select **Edit Features** then **Start Editing**.

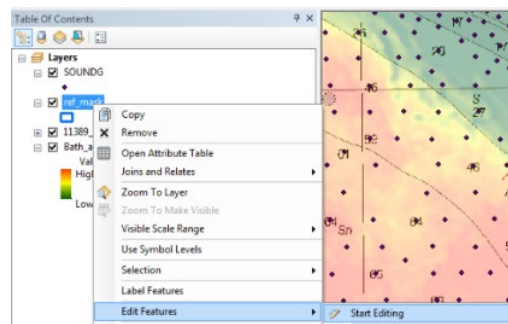

You may get the following message, press **Continue**.

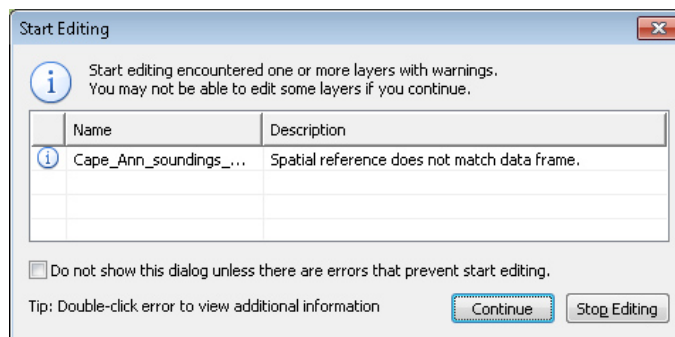

In the **Create Features** window, select the `Ref_mask` feature and select the **Polygon** option in the **Construction Tools** window.

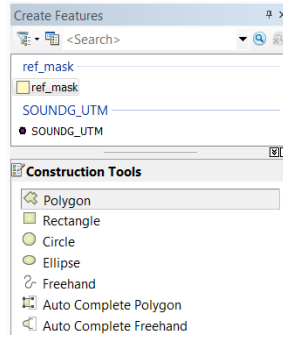

Note: In case the **Create Features** window does not appear automatically, select the **Create Features** icon from the **Editor** toolbar.



Digitize the areas considered clean from sediment plumes by visually determining a polygon around the clean area. Make sure to extend the polygon into the deep water in order to calculate the extinction depth. Double-click to finalize the polygon.

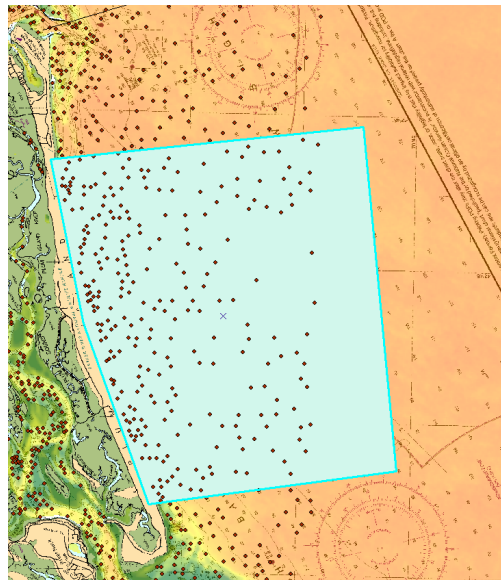

Note: In addition to turbid areas, the near-shore bottom presented on the chart should look similar to the SDB result. Make sure to avoid digitizing near inlets as the bottom is very dynamic and the sounding may differ from the SDB result.

In the **Editor** toolbar, select **Save Edits** and then select **Stop Editing**.

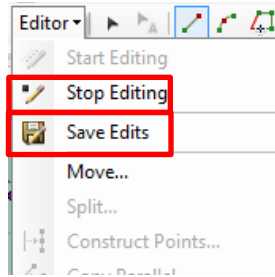

In **ArcToolbox**, select **Analysis Tools/Extract/Clip**.

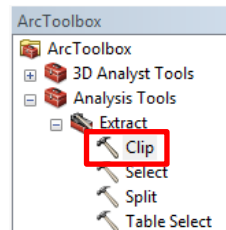

For the **Input Features** select the point feature file (*SOUNDG*), *ref_mask* for the **Clip Features** select and name the output feature class to *points_extract*.

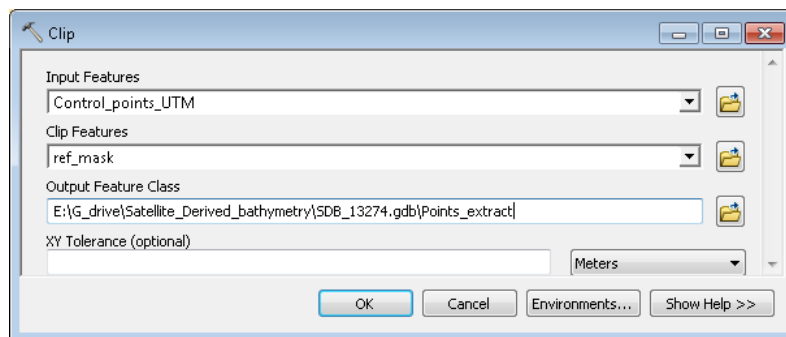

In **ArcToolbox** select **Spatial Analyst Tools/Extraction/Extract Values to Points**. This function will allow to sample the algorithm result based on the point feature (*point_extract*).

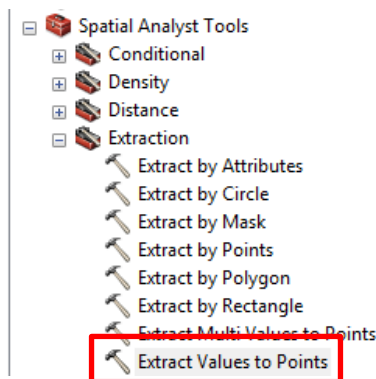

Select *points_extract* for **Input point features**. Select the algorithm results (*Bath_alg*) for **Input raster**. Rename the output feature class to *point_alg* and press **OK**

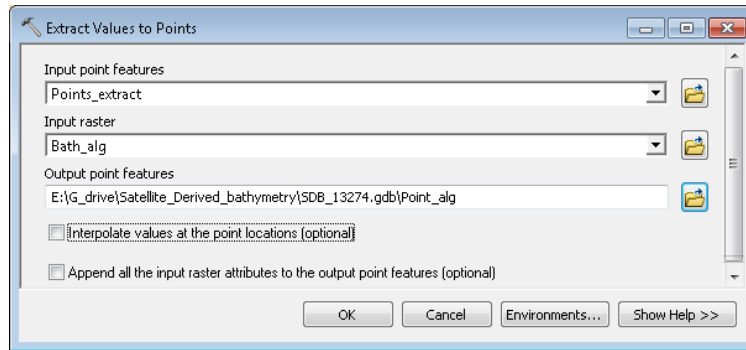

Right-click the *point_alg* layer and select **Properties**.

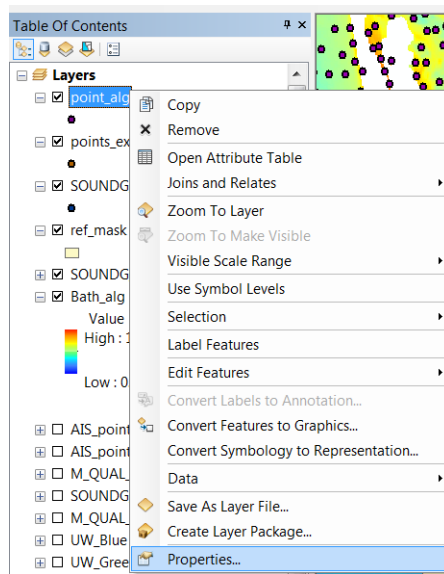

Select the **Fields** tab in the Layers Properties window and turn off (uncheck) every field except for the depth measurements (Depth or DEPTH_M, depend on the control points) and the algorithm results column (RASTERVALU). To turn a field off, click the checkboxes off and click **OK**.

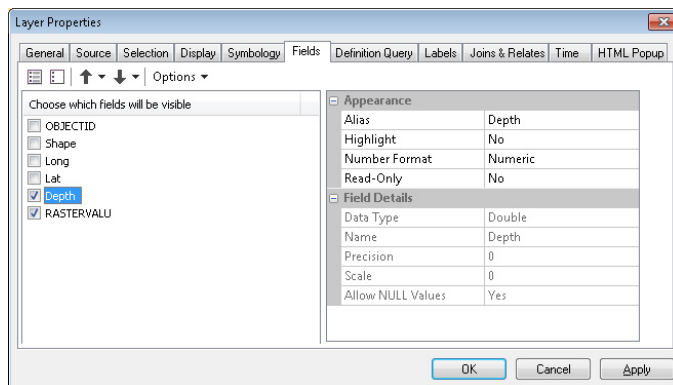

Right-click the *point_alg* layer and select **Open Attribute Table**.

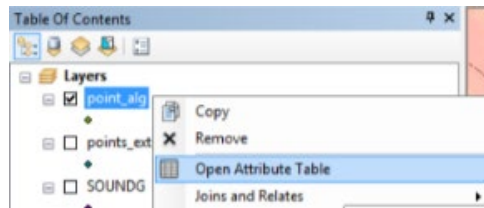

The attribute table should contain only the depth column and the RASTERVALU column.

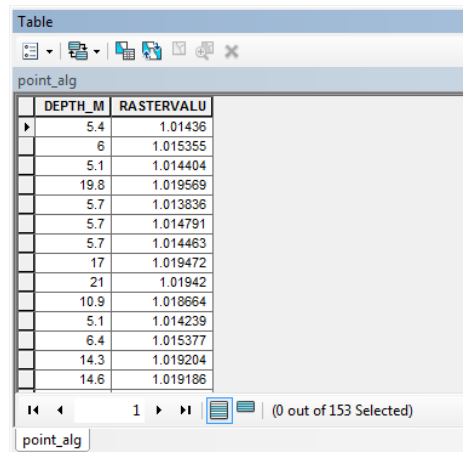
A screenshot of the 'Table' window showing the attribute table for the 'point_alg' layer. The table has two columns: 'DEPTH_M' and 'RASTERVALU'. The data is as follows:

DEPTH_M	RASTERVALU
5.4	1.01436
6	1.015355
5.1	1.014404
19.8	1.019569
5.7	1.013836
5.7	1.014791
5.7	1.014463
17	1.019472
21	1.01942
10.9	1.018664
5.1	1.014239
6.4	1.015377
14.3	1.019204
14.6	1.019186

The status bar at the bottom indicates '(0 out of 153 Selected)'.

Note: Make sure to select both column by clicking on the field headers.

Open the **Table Options** in the **Table** window and select **Export**.

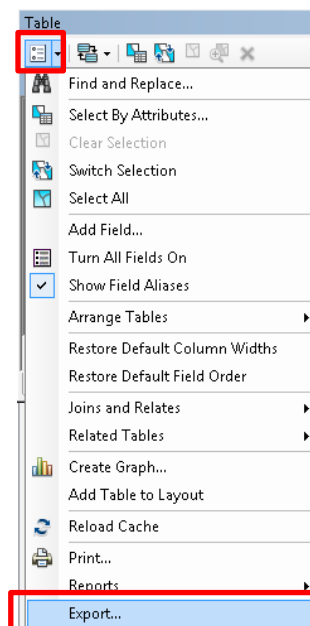

Select a destination folder to save the exported data through the Browse folder icon.

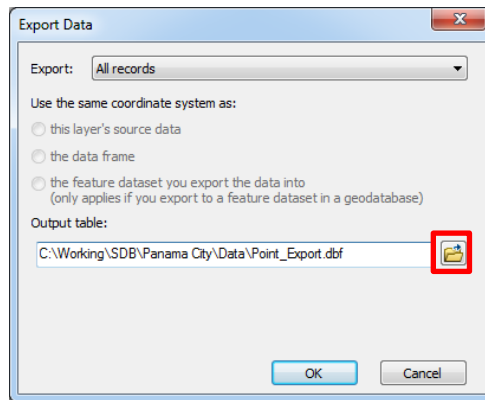

Select **Save as type: dBASE Table** and name the file *Point_Export*.

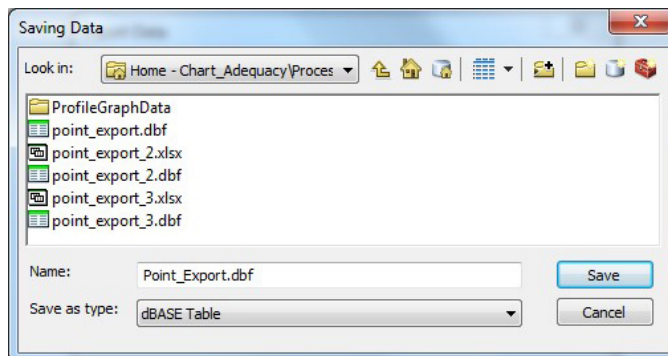

Select **No** when it asks to add the new table to the current map.

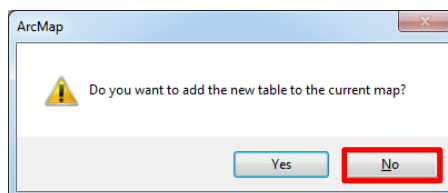

Note: The next steps are in MS Excel.

Open MS Excel.



Open the saved "*Point_Export.dbf*" file in MS Excel. In the **Data** tab, select **Sort**.

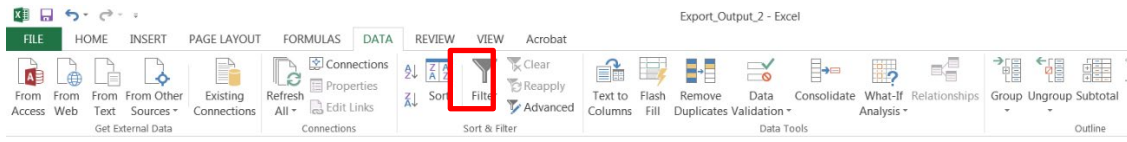

In the **Sort** window, Select **RASTERVALU** as the **Column** and **Smallest to Largest** as the **Order**. Press **OK**.

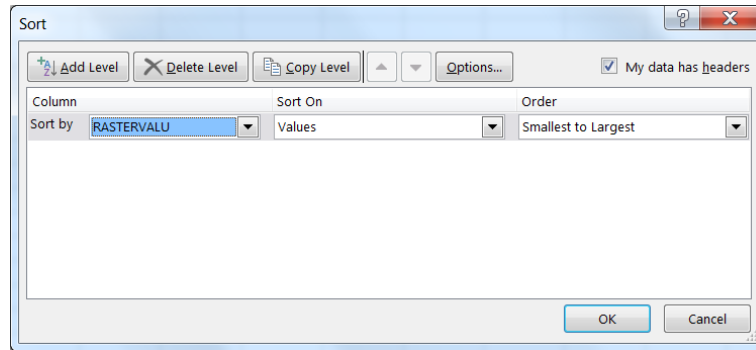

Delete all values of -9999 (that represents no data) under the **RASTERVALU** cell and the corresponding **Depth** cell by right-clicking the highlighted cells and selecting delete. Then select shift cells up.

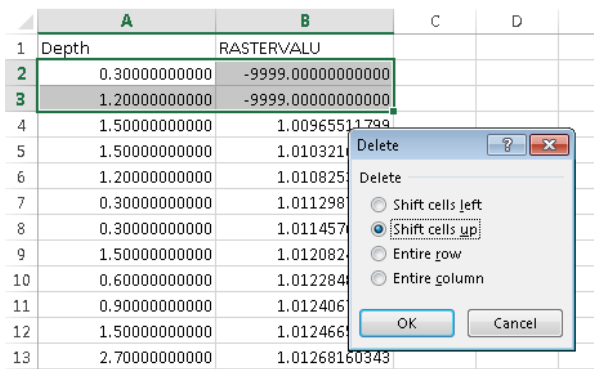

Select again **Sort** in the **Data** tab.

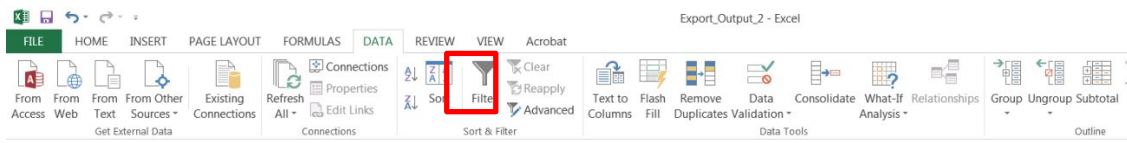

In the **Sort** window, select **Depth** as the **Column** and **Smallest to Largest** as the **Order**. Press **OK**.

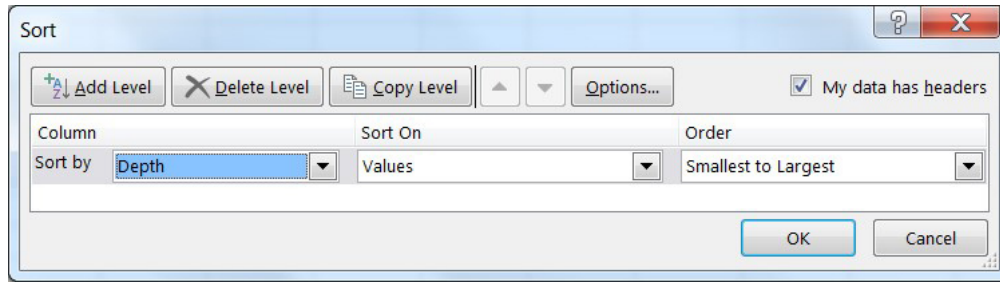

Note: In case of using survey data, make sure to round the depth values to one decimal point. Otherwise, each depth point might have its own unique value.

Select the **Advanced** option under the **Data** tab.

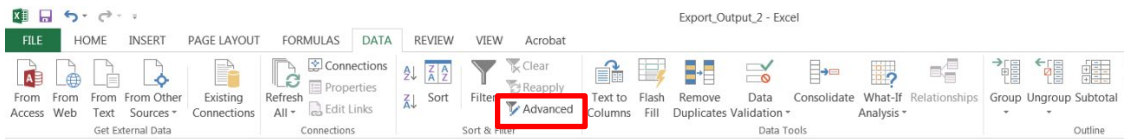

The default **Advanced Filter** window will show the cell range of the whole dataset. Modify the **List range** to only the A column, type **Copy to:** E:E, check the **Unique records only** box, and press **OK**.

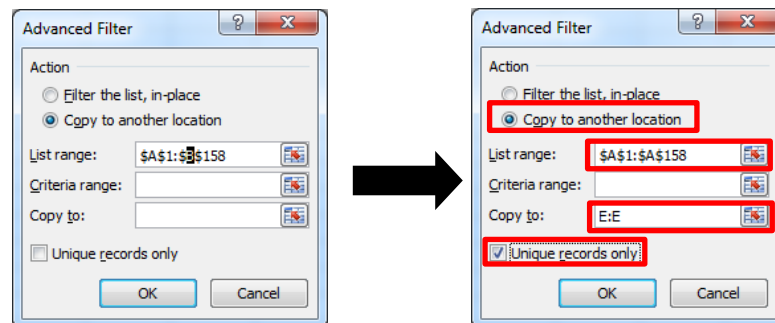

Column E will have all the depth values organized.

	A	B	C	D	E	F
1	DEPTH_M	RASTERVALU			DEPTH_M	
2	4.500000000000	1.01386141777			4.5	
3	5.100000000000	1.01440405846			5.1	
4	5.100000000000	1.01423859596			5.4	
5	5.100000000000	1.01387035847			5.7	
6	5.100000000000	1.01426672935			6.0	
7	5.100000000000	1.01437878609			6.4	

Type in cell D1 the text *Average*, and type the following term in cell D2: $=AVERAGEIF(A:A,E2,B:B)$ and press **Enter**.

Select all the depth values and SDB values from columns D and E that are below the Extinction Depth (it also recommended to start at depth values above 1 to 2 m, depending on the site).

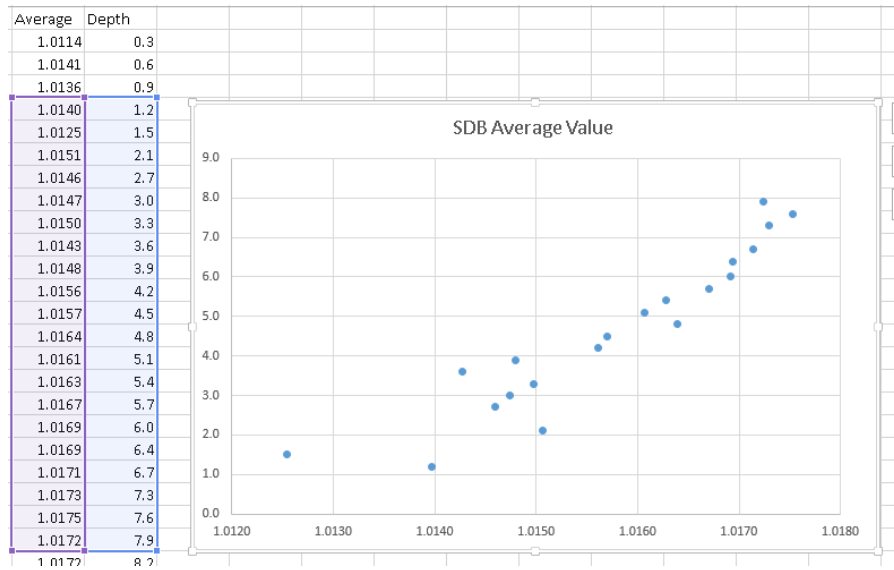

You will receive a scatter plot that will be a linear line, right click on one of the markers and select **Add Trendline...**

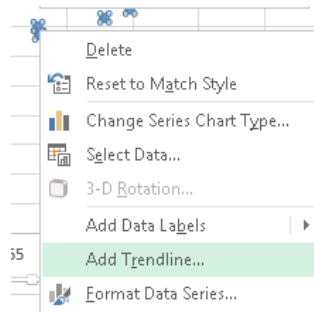

Make sure the **Trend/Regression Type** is *linear*. Check the **Display Equation on Chart** and **Display R-squared value on chart** boxes and press **Close**.

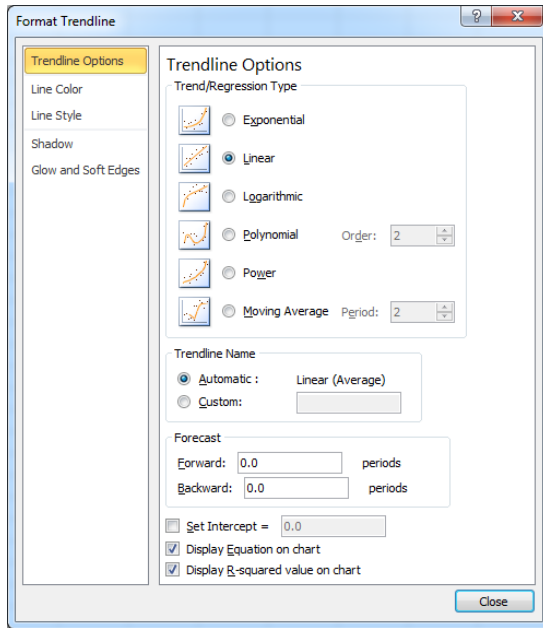

The resulting equation of the trend line is used for the referencing (in this example, the gain is 1393.8 and the offset is -1141.1).

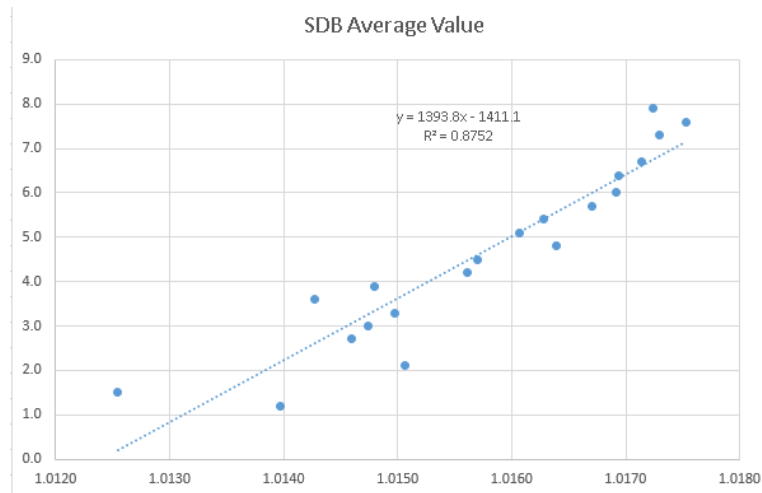

Save the Excel Spread sheet into the Data directory as *Extinction_Depth.xlsx*. (Excel Workbook in Excel 2007).

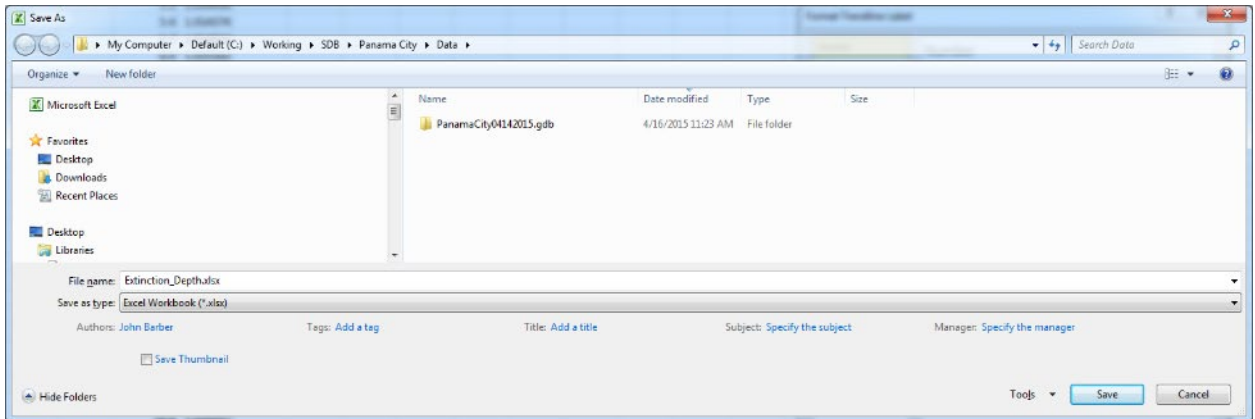

11.4.2 SDB - Applying the gain and offset (referencing)

In ArcMap, select in the ArcToolbox Spatial Analyst Tools/Map Algebra/Raster Calculator.

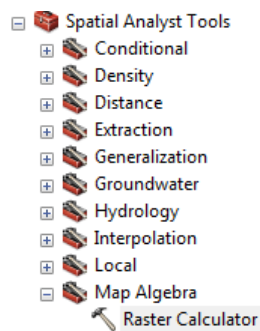

Select the algorithm layer and multiply the algorithm layer by the gain value from the excel sheet, and then subtract the offset value. Save the file as "*calc_bathy*" and press **OK**.

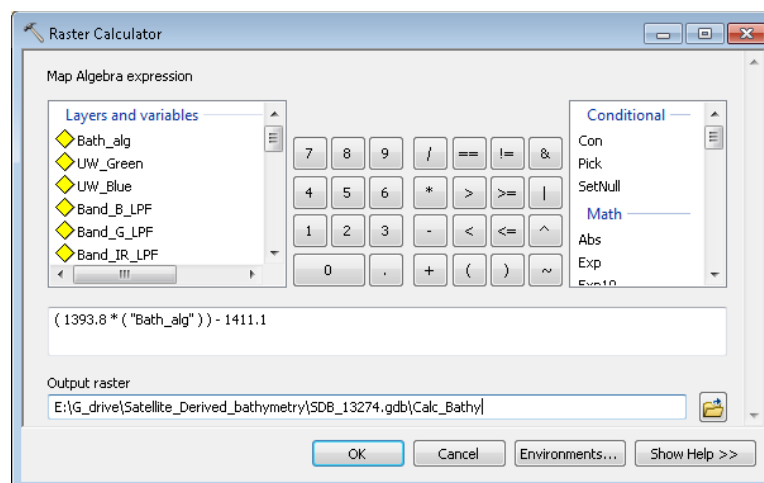

Using the Identify button click on a few “point_alg” point (make sure that **Identify from: Visible layers**) and compare the values.

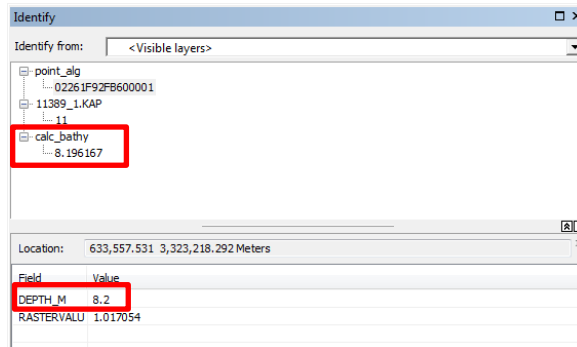

Save the project by selecting **File/Save** in the main menu.

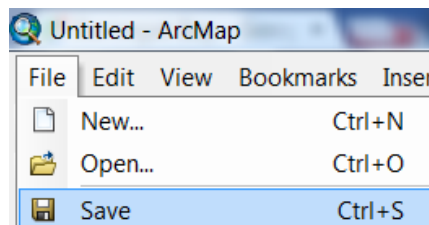

Chapter 12.0 Digital Terrain Map Editing (DTMEditing V1.6)

Contributed by Chaim Keller, The Chai Tables, Israel, and John K. Hall, Geological Survey of Israel (Retired), Israel

Purpose: Editing of digital terrain map files in 3D.

Supported file formats: (1) Surfer binary version 7 grid files, (2) xyz text height files. (Edited files can be saved in either format).

Imported File size: Depends on available video memory. For example, a file containing 1024 columns by 1024 rows requires 1.6 Gb of video memory. The program can handle larger files by breaking the file into tiles. After editing, the tiles can be merged back into a single file.

Editing tools: (1) Multiple types of smoothing tools. (2) Multiple options used for emphasizing areas needing editing in different color palettes. (3) Tools for raising and lowering heights in a region. (4) 3D visualization and manipulation.

Platform: Windows

12.1 Toolbar Buttons

(use “F12” key to toggle visibility of toolbar)



Import DTM height file either in Surfer version 7 binary grid file format or xyz ASCII height file format.



Export DTM height file either in Surfer version 7 binary grid file format or xyz ASCII height file format.



Circle tool (used for selecting different sized circular regions for editing).



Rectangular tool (used for selecting varying sized and shaped rectangular regions for editing).



Flattening tool. Opens dialog with tools for smoothing, flattening, and filling portions of a DTM file.





Palette tool. Opens dialog with tools for changing palettes globally and locally to aid in editing.

 **Filling and gouging tool.** Opens dialog for use in creating circular and rectangular mounds and pits.

 **Undo button.** Undoes the last editing change.

 **Magnify button.** Increases the vertical exaggeration by about 10%.

 **Demagnify button.** Reduces the vertical exaggeration by about 10%.

 **Help button.** Displays this document as a help file.

12.2 Navigation and Editing

rotation - arrow keys,

translation – move – x, + x, -y, +y, move mouse to left, right, bottom, top scene’s borders

zoom – mouse wheel, “z” key (zoom in), “x” key (zoom out)

joy stick – “space key” + move mouse, or press middle mouse button and drag

commit the edit – left mouse click

12.3 Toolbar Menus

File menu

 **Import** DTM height file either in Surfer version 7 binary grid file format or xyz ASCII height file format.

 **Open Tile Log file.** Opens a log file consisting of the names of tiles generated during importing an oversized Surfer binary grid file. Individual tiles are listed on the menu and can be imported by clicking on any of them. Tiles that have been opened once and marked with a check.

 **Merge tiles.** Used for merging the individual tiles after editing. The individual tiles were produced during importing of an oversized Surfer binary grid file.

 **Export** DTM height file either in Surfer version 7 binary grid file format or xyz ASCII height file format.

 **Exit** the program (You can exit the program more simply by pressing the “ESC” key anytime.)

Option menu

 **Map size.** Opens a dialog for redefining the default map size.

 **Texture size.** Opens a dialog for redefining the default texture size. Smaller textures allow for finer editing. Larger textures increase the program’s speed.

 **Palette** and scaling options. Opens a dialog that can be used for changing the scaling (height exaggeration) and the palette and heights that define the palette.

 **Lighting.** Opens a dialog for defining the direction of incident light on the 3D scene.

 **Orthographic Projection.** Reopens the file with parameters that result in an orthographic projection (instead of 3D).

 **Refresh.** Redraws the current scene using the last imported file.

Help menu (also use “F1” key when canvas has focus)

 **Help** opens quick reference of major menus and commands. Also opens with “F1” key anywhere in program.

12.4 Dialogs (accessed from the File menu)

(Note: hover over item for tooltip)

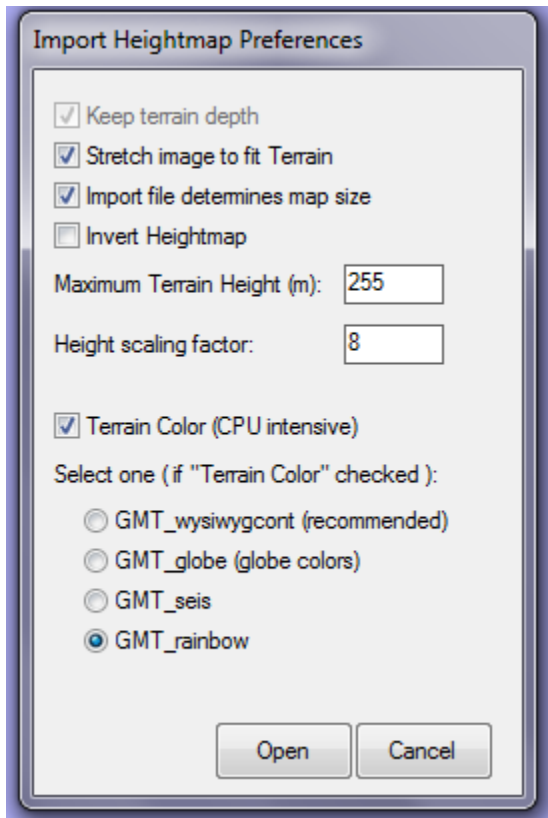

Import Heightmap Preferences dialog (above). Opens up when clicking on the Import button or when reloading a map. Check the “Input file determines map size” checkbox in order to allow the program to find the optimal map size. Uncheck the “Terrain Color” checkbox to draw the scene in a grayscale. Check the “Terrain Color” checkbox to draw in color using one of the palettes listed. Change the palette used by clicking on the appropriate radio button.

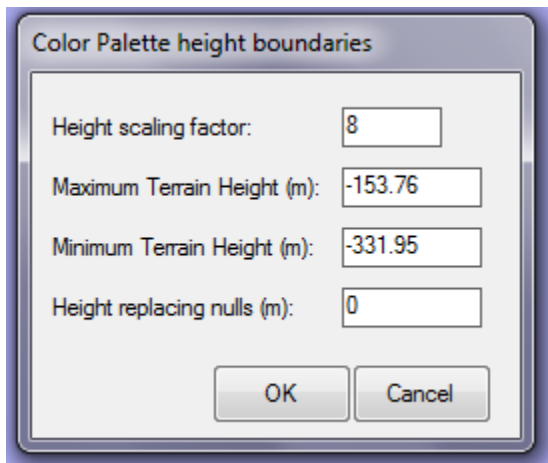

Color Palette height boundaries dialog (above). Appears only if the scene is being drawn with a palette. It appears after clicking the “Open” button in the “Import Heightmap Preferences” dialog and choosing a map file or when reopening a map. The “Height scaling factor” is the default height exaggeration factor. “Maximum and Minimum Terrain Heights” are the files

maximum and minimum elevations, respectively. These values define the range of heights used for defining the range of heights that are painted in unique colors. Null values in the input file are replaced by the height defined in the “Height replacing nulls” textbox.

12.5 Dialogs (accessed by pressing buttons on the tool bar)

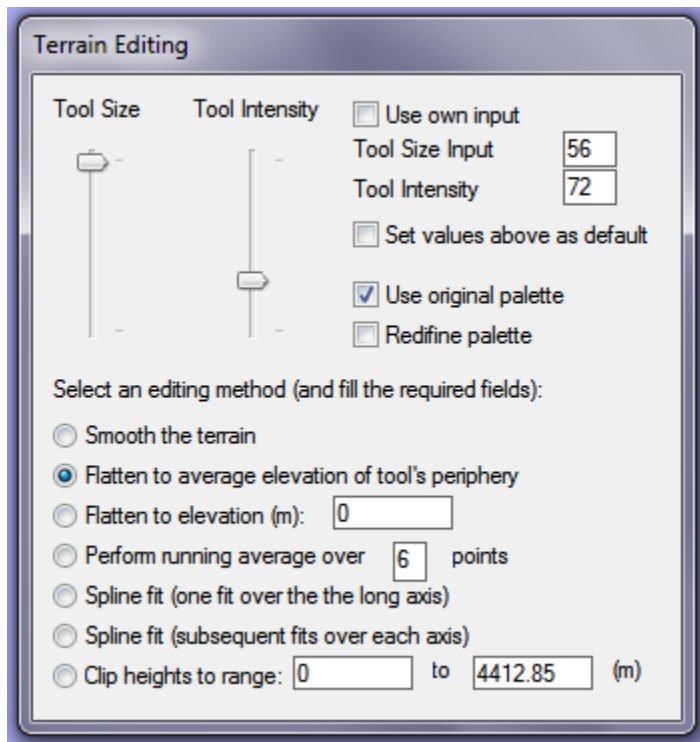

Tool Preferences (above). Appears when clicking the “Flattening” button on the toolbar (see above). “Tool Size” changes the size of the tool icons (circular or rectangular). “Tool intensity” changes the aspect ratio when using a rectangular tool. In order to perform the chosen type of editing, click on the portion of the map that is in need of editing. Only the region within the circular or rectangular tool will be edited.

There are seven different types of smoothing tools available.

1. *Smooth the terrain* – replaces the terrain height with the average height of nine nearest neighbors.
2. *Flatten to average elevation of tool's periphery* - extrapolates to the heights within the interior of the cursor from the heights on the cursor's border by using a straight line approximation and taking the average over both directions.
3. *Flatten to elevation* – substitute the elevations interior to the cursor with the inputted height.
4. *Perform running average over n points* - interpolate the height at interior points of the cursor from a running average over n/2 points on either side of the interior point. If the cursor is elongated in one direction, then a running average is only done in the elongated direction. If there is no cursor elongation, then the averaged running average over both directions is used.
5. *Spline fit over the cursor's long axis* – uses the spline routines of P. Bourke and D. Cholaseuk (see <http://www.flanguasco.org/VisualBasic/VisualBasic.html>) along the long axis of the cursor to fit the interior points of the cursor.

6. *Spline fit over each axis* - performs a spline fit of method 5 subsequently in each direction, and then takes the average of the two fits.
7. *Clip heights to range* - If a point's elevation interior to the cursor is larger than the entered range, it's height is changed to the entered maximum height. If its elevation is less the entered lower height, the elevation is set to the minimum height.

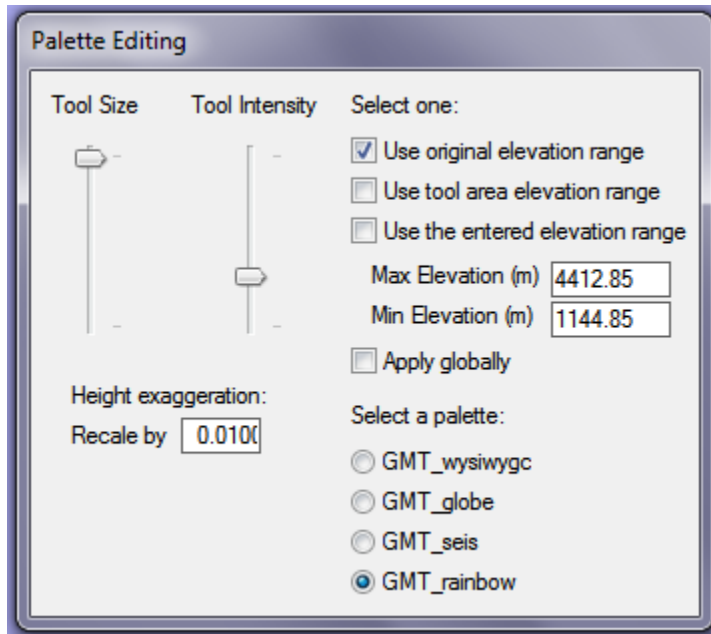

Palette Preferences (above). Opens when clicking on the Palette button on the toolbar. Click on “Use original elevation range” to repaint areas, whose colors were changed, with the original colors. Click “Use tool area elevation range” to define a local palette based on the range of heights within the circular or rectangular tool. Click on “Use the entered elevation range” to set the palette by hand. Click “Apply globally” to apply the new palette globally. A new palette can be chosen by clicking on one of the four palette options. Change the height exaggeration (scaling) by adding an integer scale (multiplies the heights). In order to invoke the changes inputed in the dialog above, click on the map.

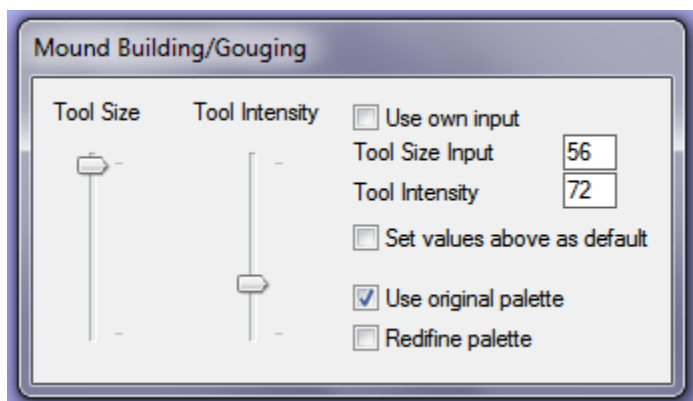

Tool Preferences (above). This dialog appears when clicking on the “filling and gouging” tool on the toolbar. The intensity of the filling and gouging is determined by the “Tool Intensity”.

The region that is filled or gouged is defined by the “Tool Size”. Fill by right clicking on the appropriate place on the map, gouge by left clicking.

12.6 Dialogs (accessed from the Option menu)

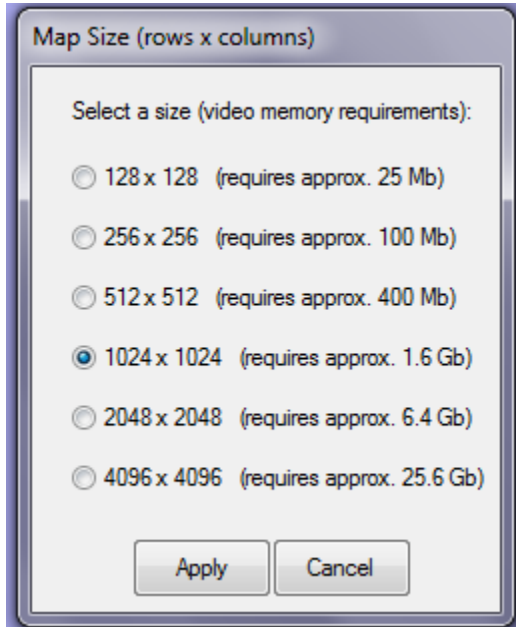

Map Size. Appears when clicking the map size menu. Use this dialog to define the default map size that is limited by the computer’s video memory.

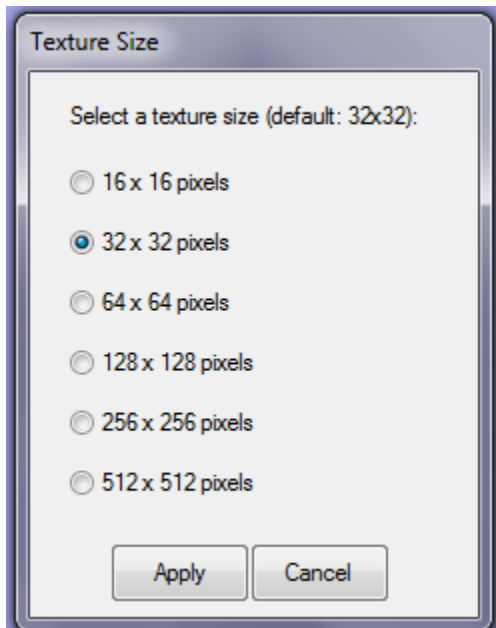

Texture Size. Appears when clicking on the “Texture Size” menu. Used for defining the default layer size. Smaller layers allow for finer editing, but add to the computation time. These values can only be changed before loading a file.

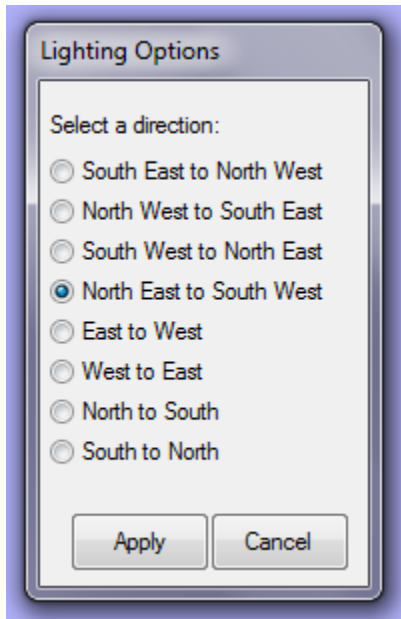

Lighting Options. Used for changing the direction of the ambient light. Appears when clicking the “Lighting” menu. Experiment with this dialog to produce the best lighting.

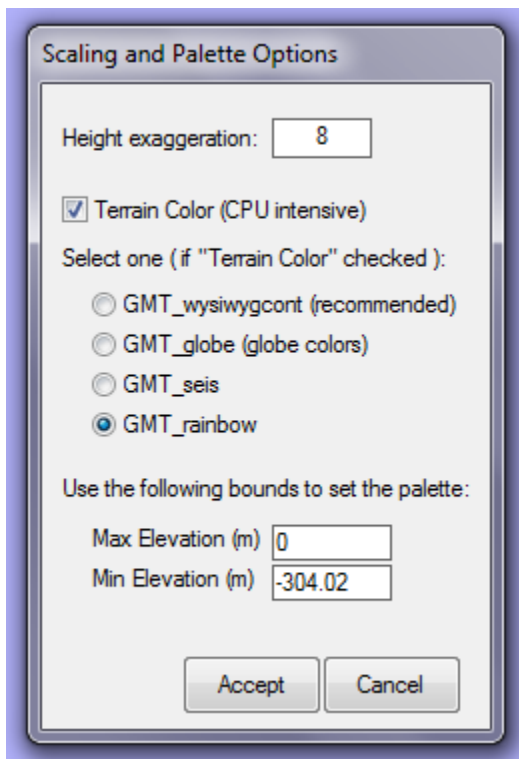

Scaling and Palette Options. Appears when clicking the “Scaling and Palette Options”. Change the height exaggeration and or height range for defining the vertex colors. Press “Accept” to repaint the 3D image using the entered values.

12.7 Brief Manual (for files that can be handled with available video memory)

Click on the “Import” button on the keyboard. Press “Accept”, then choose a file (typically a Surfer version 7 binary grid file) to load. Press accept, and then press “Accept again” for the next dialog that appears. The file is then read and plotted. Choose a tool type from the toolbar. Begin editing by clicking on the “Flatten” tool. Highlight a region with a new palette by clicking on the “Palette button” on the toolbar. Change the height exaggeration either by using the magnification buttons, or by entering an exaggeration scale by hand in the Palette tool dialog (accessed using the “Palette button”). If the toolbar gets in the way, press “F12” to remove it from sight (and press “F12” again to make it reappear). When editing is completed, save your work by clicking on the “Export” button on the keyboard.

12.8 Full Manual

File size considerations

DTMEditing can edit any Surver version 7 binary “grd” file size by either breaking up the file into tiles for indiviudal editing (the individual tiles can be merged at the end of the editing) or by reducing the resolution of the file to fit into the available memory. So if you need to edit a large file, then first convert it into “grd” format. The available memory limit is set by the “Map size” dialog shown above that can be accessed in the “Options menu”. (The tile option is not available yet for “xyz” files. However, the map size will be increased to accommodate the maximum video memory.)

Opening a file

1. Click the “Import” button (see above for its picture) or the “Import” menu item in the File menu.
2. The “Importing File” dialog (see above for its picture) appears.
3. In general, leave the check boxes alone and click “Open”.
4. A file explorer opens. Choose “grd” format or “xyz” format and then click on the desired file. The program determines if the file can be handled with the available memory. If it can, the program skips to step 18. Note that Xyz files can’t be larger than the maximum rows x columns size that your computer memory can tolerate. However, “grd” files are not limited to the computer’s memory size. Rather, if the “grd” file is larger than can be handled with available memory, the following message will appear:

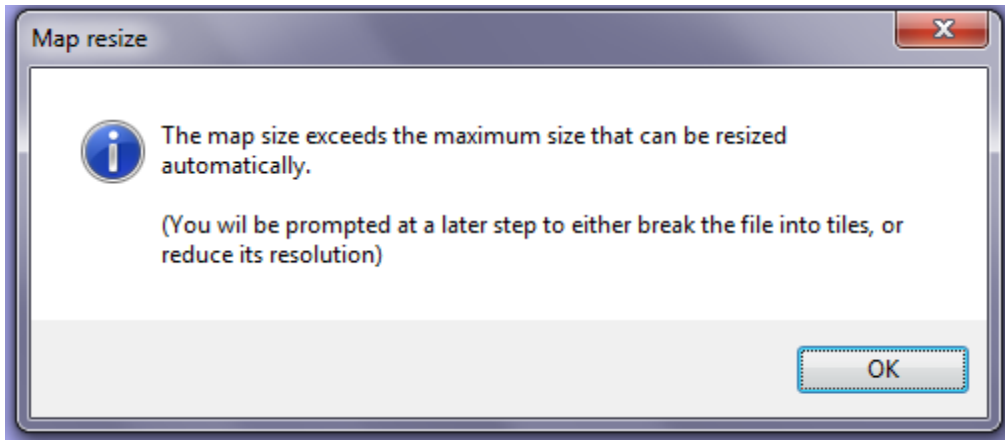

5. Press the "OK" button.
6. The following dialog appears that can be used to customize the height ranges for determining the color palette, as well as determining the scale magnification. The program makes a good attempt to determine these scales automatically. In general, it does a pretty good job, so you can just trust the defaults. Nulls are usually replaced by zeros. You can change the value in this dialog if you wish.

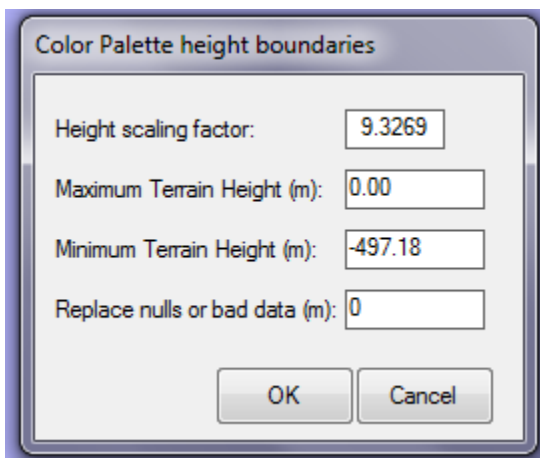

7. Press the "OK" button.
8. If you had received the "too large file" warning above, then the following message box will appear

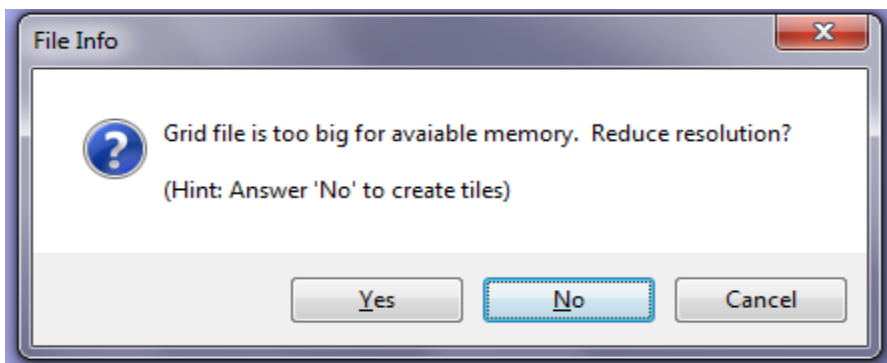

9. If you want to create tiles of the size set in the "Map size" dialog (see above), then answer "No". If you answer "Yes" then the program will reduce the resolution of the file to make it fit into the available

memory. We will press “No” in order to review the tile creation process (the “Yes” option is straightforward and doesn’t need further explanation).

10. If the map size was set to 1024 x 1024, then the following dialog will appear:

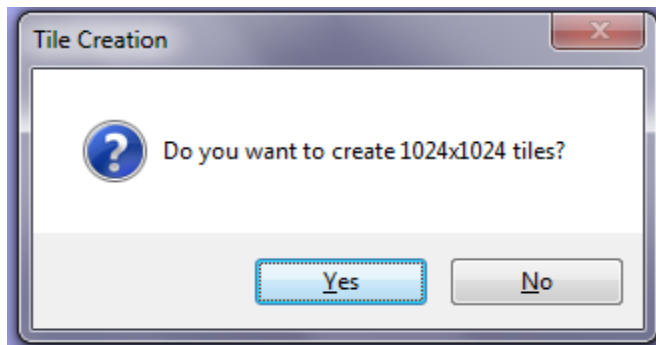

11. Press “Yes” to begin the tile creation process.
12. The program then reports is the root filename of the tiles; press “OK”, and the data extraction process begins. The first stage of data processing is stuffing the data into the correct 1024 x 1024 data buffer, after which the 1024 x 1024 tiles are generated one at a time. All along this process, the program reports the progress. . Warning: this process can take quite a bit of time, depending on data size. As a final step, a tile “log” file is generated with all the names of the tiles and containing information on their editing status.
13. After the data processing is completed, the program returns to its resting state.
14. To load the stored tiles, click on the “Open Tile log file” menu item in the File menu (see above).
15. A file explorer opens with a list of all the “.log” files. Click on the correct one.
16. The individual tiles are then loaded into the File menu as shown below. If a file has been edited, a check will be present next to its name in the menu. In this way, you don’t have to remember which tiles have been edited.

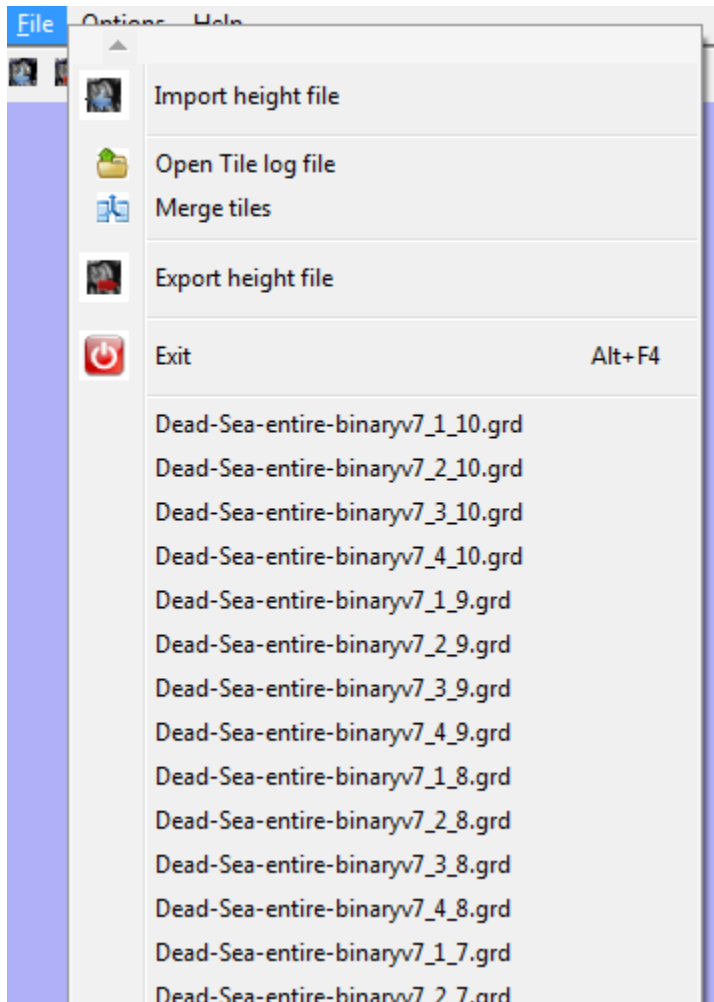

17. To open one of the tiles for editing, click on its name. The procedure that follows afterwards is identical to opening a file whose size can be handled by the available memory.
18. The Color-Palette height boundaries dialog appear (see above). The program usually does a good job in determining the rescaling factor. So it is usually sufficient to just press the “OK” button.
19. The program begins to read the file and processes the data for plotting in 3D with the chosen color palette. This can take some time. After the process finishes, the 3D image of the file appears on the screen ready for editing. An example is shown below.

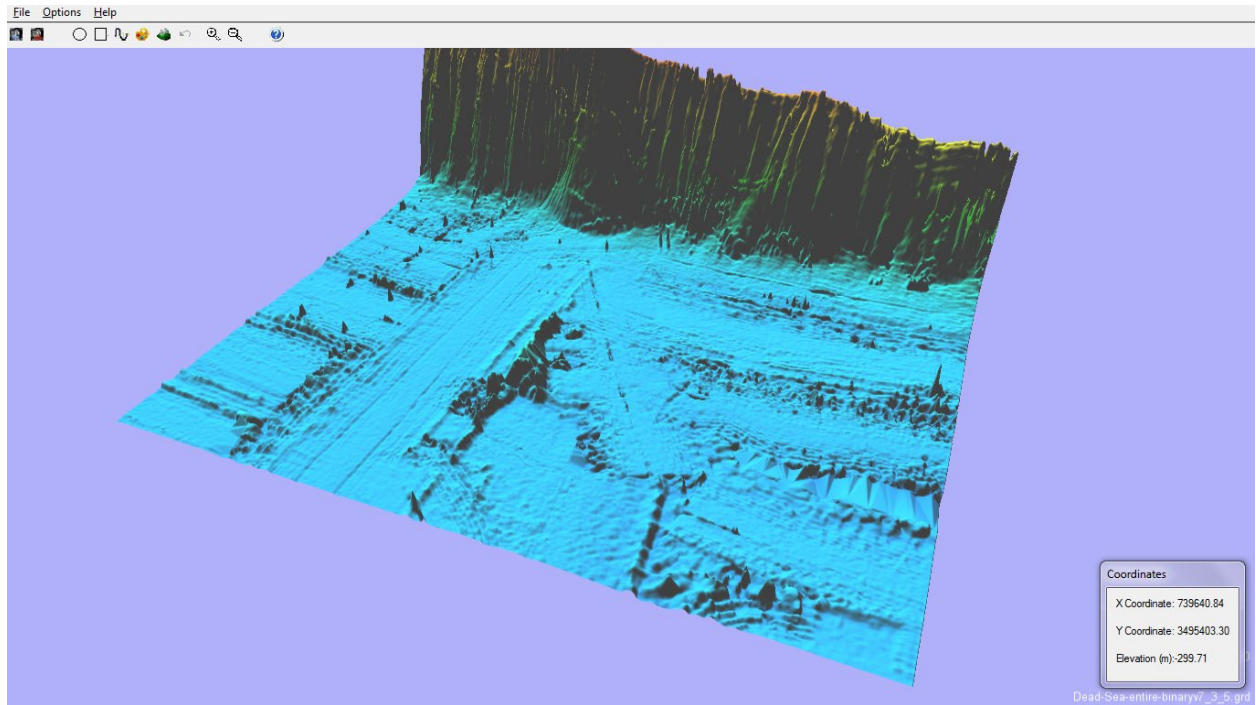

20. The editing tools on the toolbar have now become enabled. Notice the “Coordinates” window on the bottom right. A continuous readout of coordinates and heights are given as the mouse moves over the terrain. The name of the file is written on the screen below the “Coordinate” window.
21. There is no one way to successfully edit out artifacts and glitches in the data. We will illustrate a few of the tools, but in general each terrain will require a different editing method. For this reason, quite a few methods are provided in this program.
22. Move the terrain around by moving the mouse to the scene’s borders. For example, to move up, place the mouse on the top border. To rotate, use the arrow keys. For much faster rotation control similar to a joy stick, press the “space bar” while moving the mouse. The terrain will easily rotate in any direction to follow the motion of the mouse. Zoom in and out with the mouse wheel.
23. We will start our editing by defining a local palette over the region we plan to edit. This will allow us to magnify the glitches and allow us to follow our progress in editing the out. To do this, click on the “Palette” toolbar button (see above). In the picture below, a rectangular cursor was chosen. You can easily switch between rectangular and circular cursors by clicking on the circle or rectangle buttons on the toolbar (see above). The size of the cursor is controlled by the “Tool Size”. The shape and direction of the rectangle is controlled by the “Rec. Aspect”. Notice how the cursor lies over the terrain, moving up and down as the terrain changes height. (If a circular cursor was chosen, then “Rec. Aspect” becomes “Tool Intensity” instead.) If you want to easily change the tool size or aspect during edit, click on the slider button and use the mouse wheel to change the slider’s value.

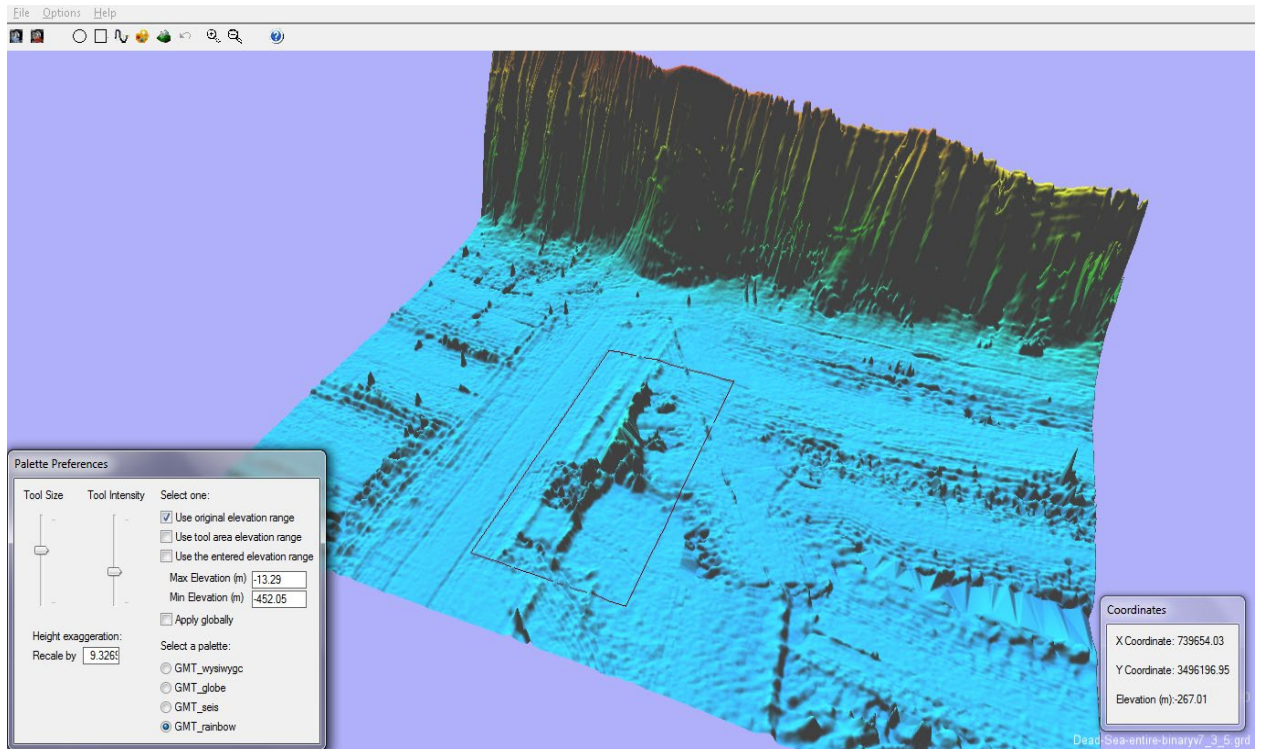

24. Left click with the mouse to begin calculating a new palette. To define a local palette based on the maximum and minimum heights within the cursor, click the “Use tool area elevation range” check box (you first need to uncheck any other checkbox). The picture below shows the result. We can always return to the original palette defined by the original elevation range by rechecking “use original elevation range” checkbox. We can also make the palette, defined by the cursor elevation range, universal throughout our terrain by clicking on the “Apply globally” check box.

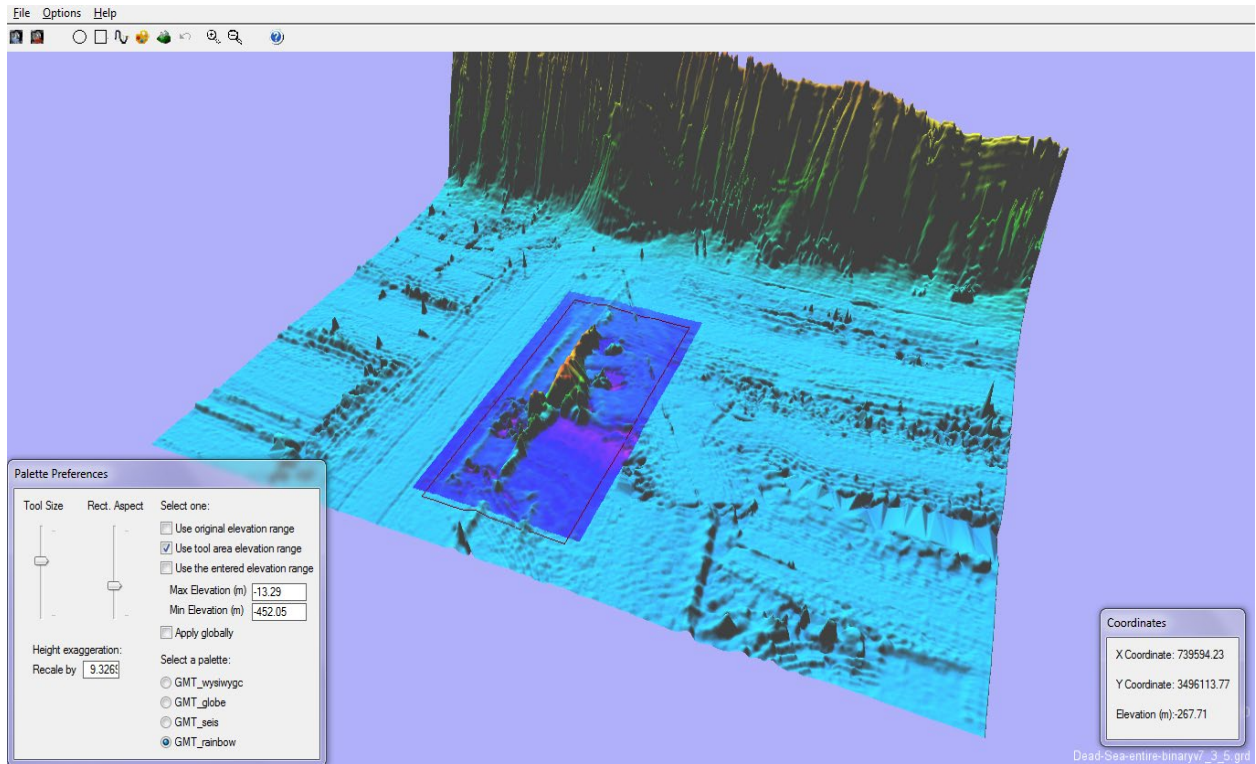

25. We can also change the lighting direction in order to emphasize terrain features. To do that, click the “Lighting” menu item in the “Options” menu (see above). The “Lighting Options” dialog box appears (see above). Pick a new lighting direction and press “Apply”.
26. We now begin to edit the selected region by pressing the “Flattening tool” on the toolbar. We will use the “flatten to average elevation of tool periphery” tool. The result below was obtained by flattening first in one direction, then in the next. We changed directions by clicking on the “Rect. Aspect” slider and moving the wheel mouse to change the direction of the rectangle. Each time we want to edit, we left click with the mouse. We also have the “redefine palette” checkbox checked in order to use the new palette we defined in step 24. We have basically finished editing the chosen region.

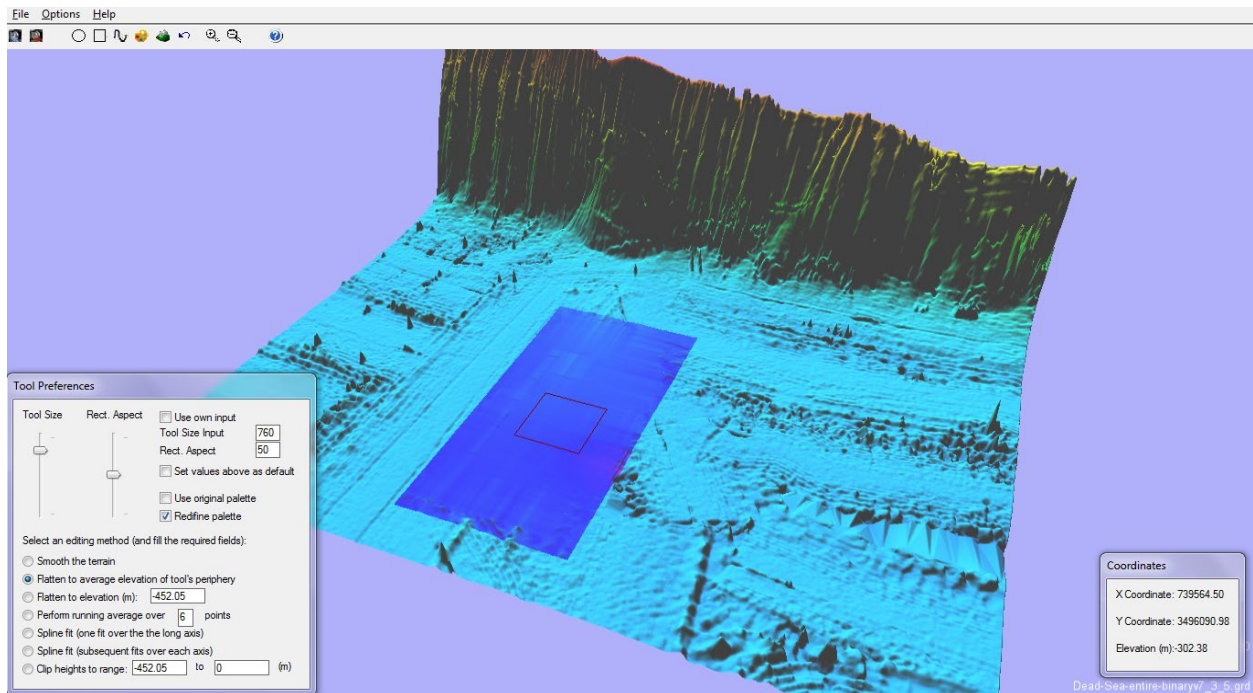

27. We then restore the palette in the region by clicking on the “Palette” toolbar button, clicking on the “use original palette” checkbox (see picture below for the result), redefine the size of the cursor to cover the entire region in interest, and then left click with the mouse.

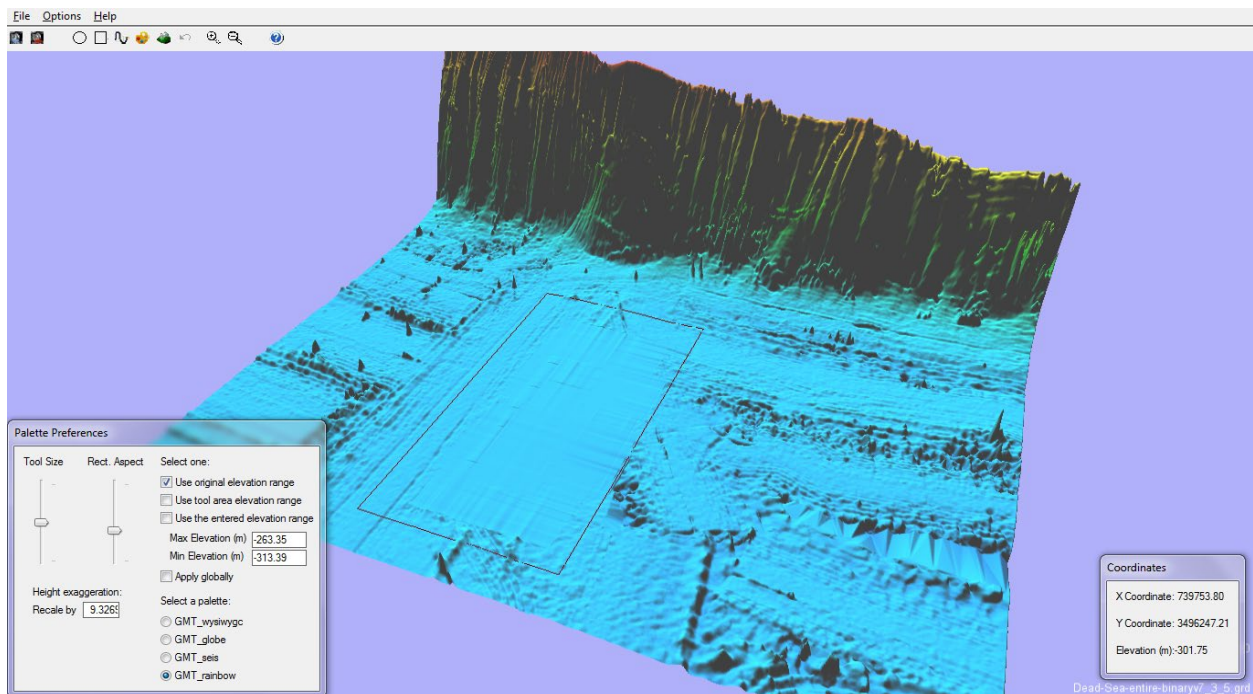

28. To understand the function of the smoothing tools, see the discussion after The “Smoothing” dialog box above.

-
29. When we are finished editing this tile or file, we press the “Export” button (see above) on the toolbar. A file explorer appears. The original name of the tile or file is highlighted. We press “Save”, the program warns us that we are overwriting the original file, we press “Yes”, and the editing we did is saved.
 30. We then return to the “File” menu, and notice that the tile we edited is now checked. (see below).

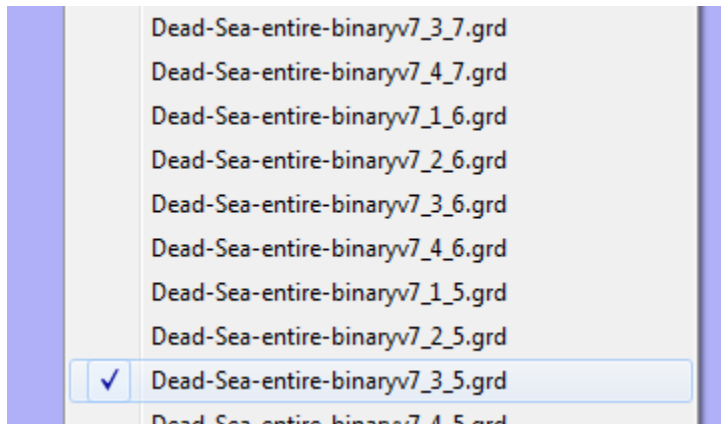

31. To edit a different tile, we simply left click on the list below of one of the unchecked names. If we try to click again on the edited tile, nothing happens. To is a safety feature to make sure that your editing is not lost. If you really want to re-edit it, then click on the name twice. Once to uncheck it. The second time to reopen it.
32. When all the tiles are edited, merge the edited tiles into a single file by clicking the “Merge tiles” menu item on the File menu. The default output name is the root name of the tiles with the added suffix “-merge”. Click “Save” and the process of merging begins. This completes the editing.

A few words about “xyz” format files

Note that in general there are two types of “xyz” files. The first is well-ordered files, e.g., those outputted by the Global Mapper Program. (Well ordered means that there are no missing x or y data, and the data is organized in either ascending or descending order). The second type is one with random xyz entries in no discernable order, or when there are missing entries. This program can handle both types of xyz files. Appropriate warnings and questions will appear informing the user of the type of xyz file detected and the required decisions that the user needs to make. Missing entries are giving the height values determined by the value entered into the Color Palette height boundaries dialog (see above) in the “Height replacing nulls” text box.

Reopening map files

The DTMediting program keeps track of a maximum of ten height files that have been opened in the past. These files are recorded in the text file “recent_files.txt” that resides in the program directory. This file is created after the first height file has been opened by this program. At that time, a new “Reopen” sub menu appears on the File menu (see picture below). To reopen one of the displayed files in the sub menu (example shown below), click on it.

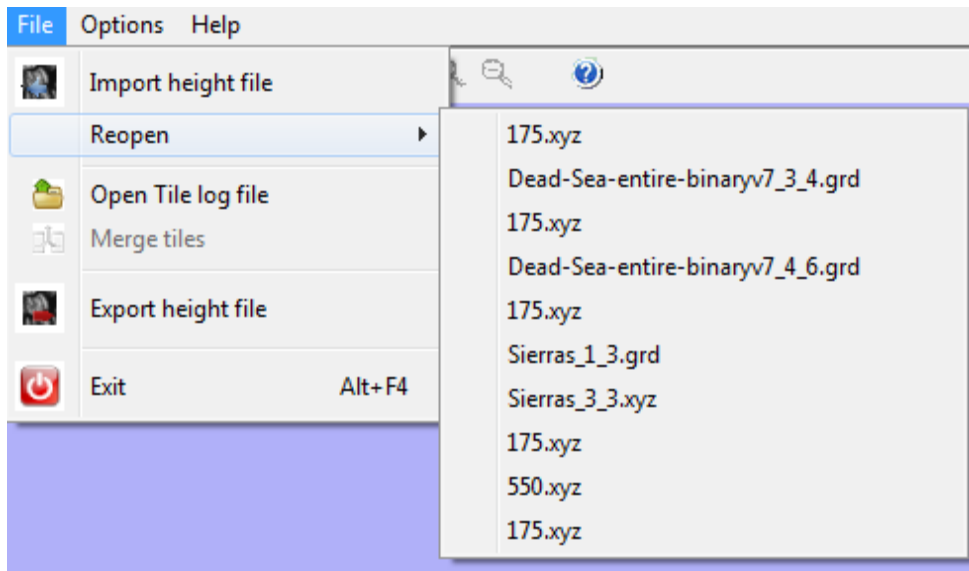

Orthographic Projections

An orthographic projection of the currently drawn 3D map can be made by clicking the “Orthographic Projection” submenu in the “Options” menu. The program will run through the procedure of redrawing the scene (including most of the dialogs shown in the “opening a file” section above). The pictures below give an example of the results. (Notice how greyscale clarifies features in the terrain, e.g., the alluvial fans penetrating into the valley.) These projections can be edited just like any 3D scene using the editing tools mentioned above. (N.b., the source of the terrain is a 1 arcsec, i.e., about 30 meter resolution, NED DEM file of a portion of the Sierra Nevada, that has been converted to “grd” format and then split into 1024 x 1024 tiles following the procedure mentioned above.)

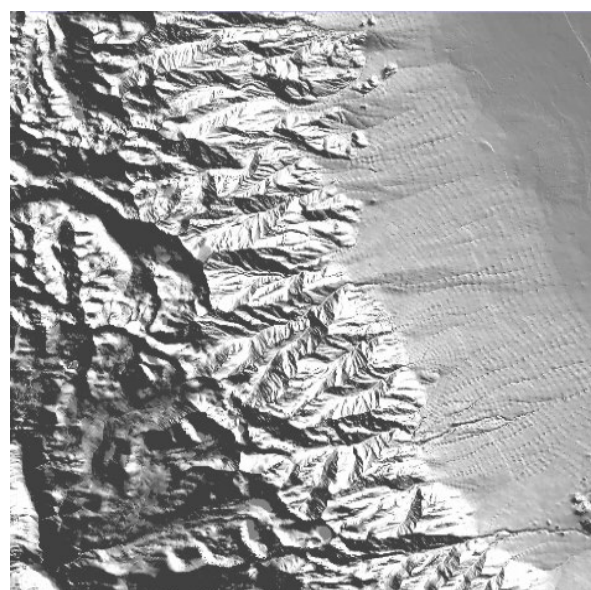
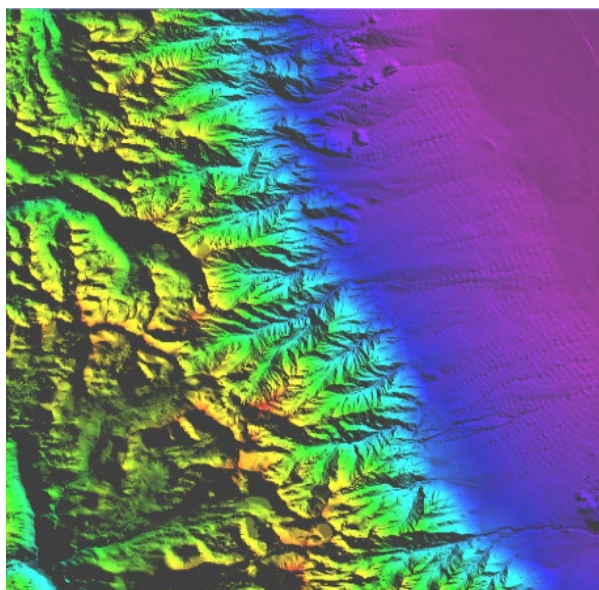

Brief Program's source code overview

This program was written in the Game Maker 8.1 scripting language. In that language, programs consists of “Scripts” (subroutines) and “Objects”. The “Objects” correspond roughly to event handler routines. They monitor dynamic events caused by the user such as key presses, mouse clicks, and mouse movement and call the appropriate “Script”. On the program’s onset, the “oController” object initializes program variables and draws the toolbar and menus. The “oTerrain” object initializes the canvas. The “oCamera” object initializes the view port. Usually the first event initiated by the user is to open or reopen a file. The “oController” objects control the response, and proceed to redirect the program flow to the importHeightMap subroutine that opens the requested file, or reopens one of the files in the Reopen submenu in the File menu. If the chosen file is a “grd” file, the file’s data is read by the script importHM_grd. If it is a “xyz” file, then it is opened by either importHM_ran_xyz for randomly ordered or unaturally truncated “xyz” files. If the file is well ordered, then the user can decide to read the file’s data by the routine importHM_xyz routine. The program flows next to the updateTerrain subroutine whose job is to calculate the shading and perspective, and then to draw it in 3D (or 2D for orthographic projections.) The actual terrain editing is done in the in the APIWindows sub object of the oTerrain object. After editing, the scene is redrawn by the update Terrain subroutine.

12.9 Download Link (latest program installation package)

http://www.chaitables.com/DTMediting_setup.exe

12.10 Download and Installation Instructions for Windows 8 and 8.1

When attempting to download and install the program on Windows 8 (8.1), Windows warns you that the setup file is not commonly downloaded and could harm your computer. **Ignore** this warning and click “Run”. Then an even bigger warning shows up with the message that “Windows protected your PC”. **Ignore** this also and click the “More info” link. Then click “Run anyway”.

Acknowledgements

My sincere thanks go to Professor John K. Hall for conceiving this program, for supervising its development with useful ideas, and for supporting its development financially. The DTMediting program is written using the “Game Maker” compiler standard version 8.1. The program began with code from the terrain generator and editing program “Terrestrial Perfection” (written by “Loverock 125”), and to a minor degree from the terrain generator and editor program 'GMTerrainEditor2' (written by “Master Xilo”). (Some of the capabilities of those programs have been removed, much code has been heavily modified and much new code has been added

in order to produce an editor for DTMs instead of a terrain generator.) Code for reading binary files was written by “Walking Code: IsmAvatar”. Code for window type menus was written by Ravotus (N_Menu dll). The program also makes use of other code and dlls found in GMLscripts.com and.gmtoolbox.com. In case I forgot to thank someone, let me express my thanks to all the code sources originating from the Game Maker community.

To do (for someone out there....)

Convert the program to Game Maker Studio compatible code. This will allow for compilation into native code and hopefully increase the speed of the number crunching routines by an order of magnitude.

Chapter 13.0 Uses of CARIS

Contributed by Lt. Commander Gustavo Adolfo Gomez-Pimpollo Crespo, Instituto Hidrografico de la Marina, Spain

13.1 Mosaics in CARIS

Household steps to get mosaics in CARIS, V. 8.1, after editing and cleaning multibeam data

There are different ways to get a mosaic, from a pretty and fast mosaic (high resolution), to an advanced reflectivity mosaic (low resolution).

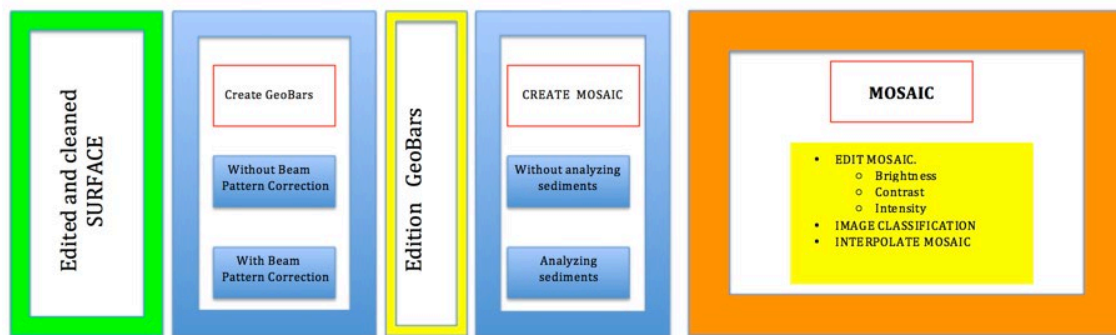

Figure 13.1 Steps to create a Mosaic.

Figure 13.1 indicates how to get different types of mosaics. The election of one-way or another depends on the purpose. If the goal is to get a fast mosaic of one specific area to see its segmentation, it is better to get a pretty mosaic without analyzing the sediments. On the contrary, if the purpose is to study and analyze the area with the samples obtained in the zone, it is recommendable to create a mosaic that analyzes the angular response.

Every mosaic depends on a set of variables: correct patch test, vessel speed, sound speed profile updating, parameters used by the operator, seafloor properties, the overlap conducted between lines, among others.

Figures 13.2 and 13.3 show the results that you can obtain once you edit, clean, and process the multibeam backscatter data in order to get a mosaic.

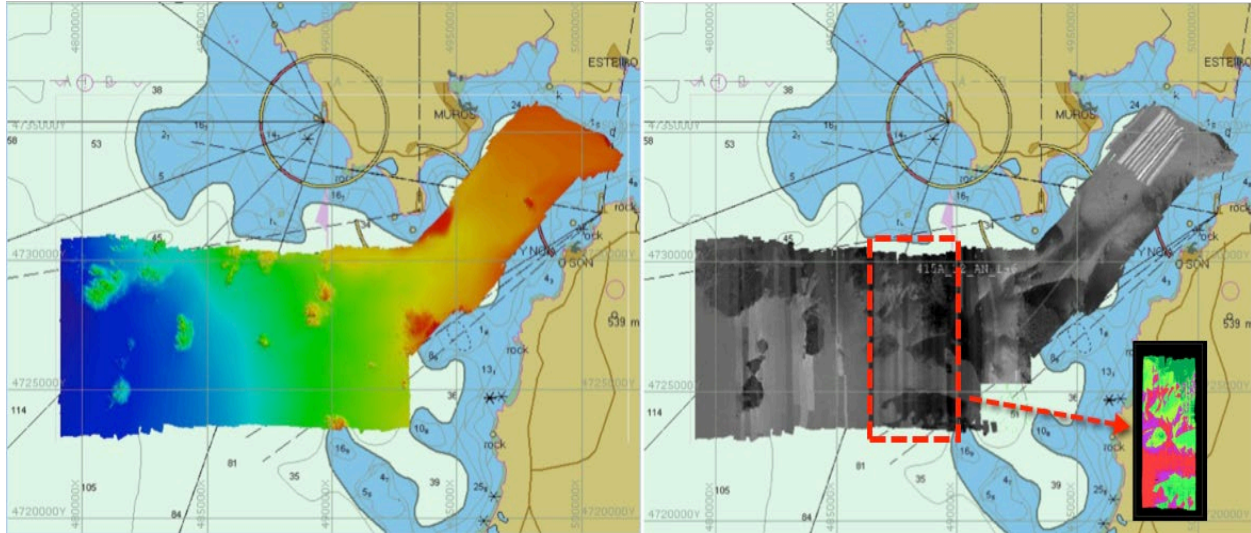

Figure 13.2 Images provided by the Spanish Navy survey vessel “Antares,” during the hydrographic survey conducted in Galicia coastal waters (northwestern Spain). This coast is also known as “The coast of death.” This specific area is the Muros Inlet.

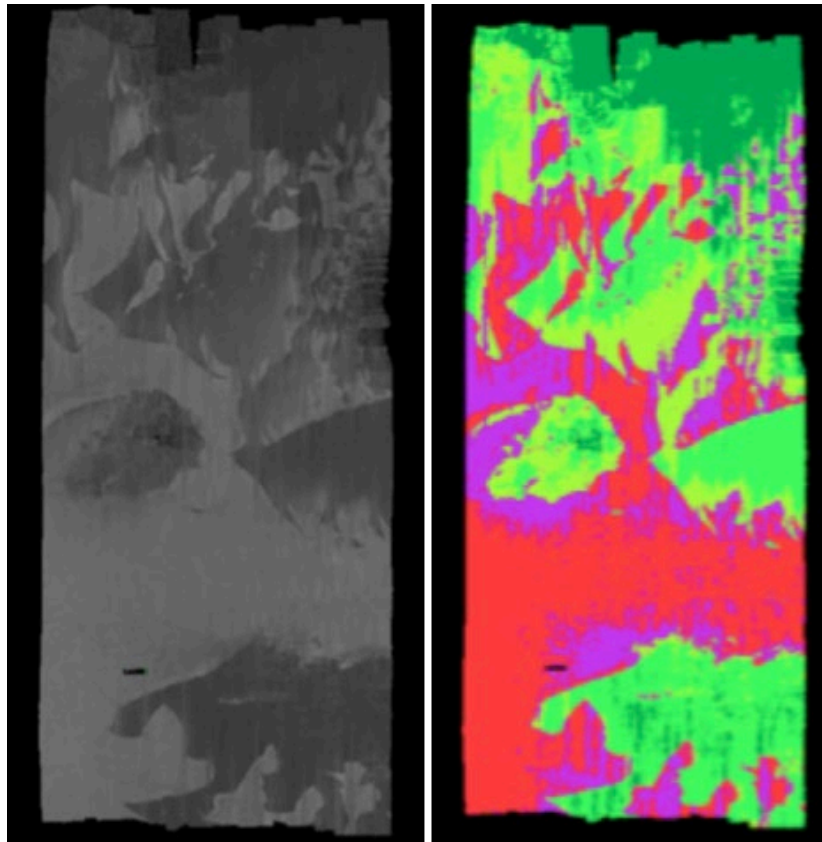

Figure 13.3 Mosaic and image classification.

13.1.1 Steps to get a pretty mosaic of an area (creating beam pattern correction)

- Open the ‘Mosaic Editor’ (tools, mosaic editor and open command). A toolbar will appear (Mosaic Editor).
- Go to the mosaic layer and take the following options in the process tab.

Processing Engine: Geocoder
Source Data Type: Time series
General options to select:
Auto gain correction
Auto TVG correction
Anti-aliasing

- Despeckle is used when there are isolated pixels with intensity levels that are different to the neighbouring pixels. Despeckle removes extreme values, but its abuse can give rise to detrimental imagery.
- Select a line to create its GeoBar (georeferenced backscatter raster) (Fig. 13.4). This line will be the reference line to make the beam pattern correction. Then, it is better to take a short line on a flat seafloor. If we know the sediment class it will be much better because it can be set.

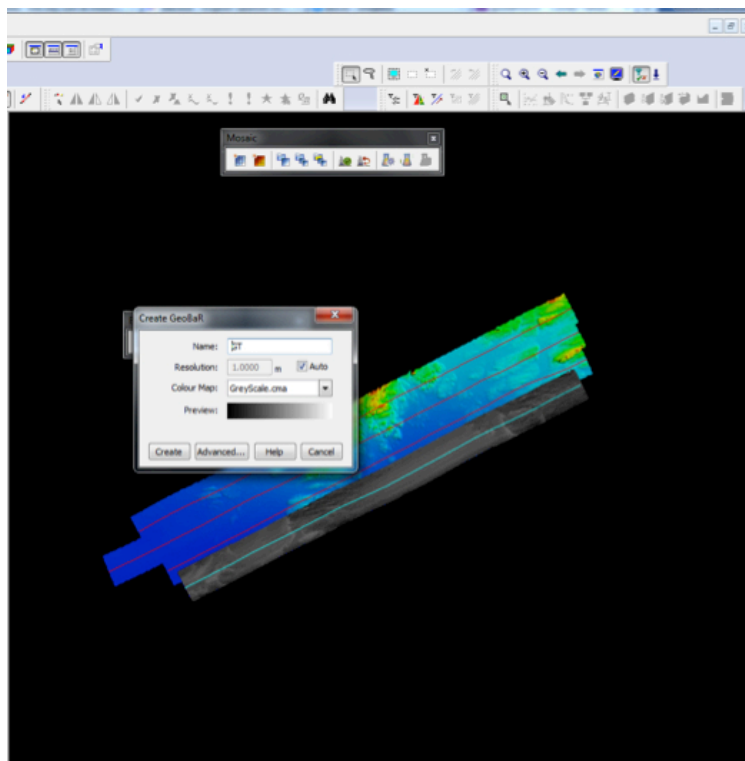

Figure 13.4 Create GeoBar.

- Create a beam pattern; go to process, ‘create beam pattern’ and click on the created line with GeoBar (Fig. 13.5). After that, save the beam pattern as a ‘bpt’ file in the session folder (Fig. 13.6).

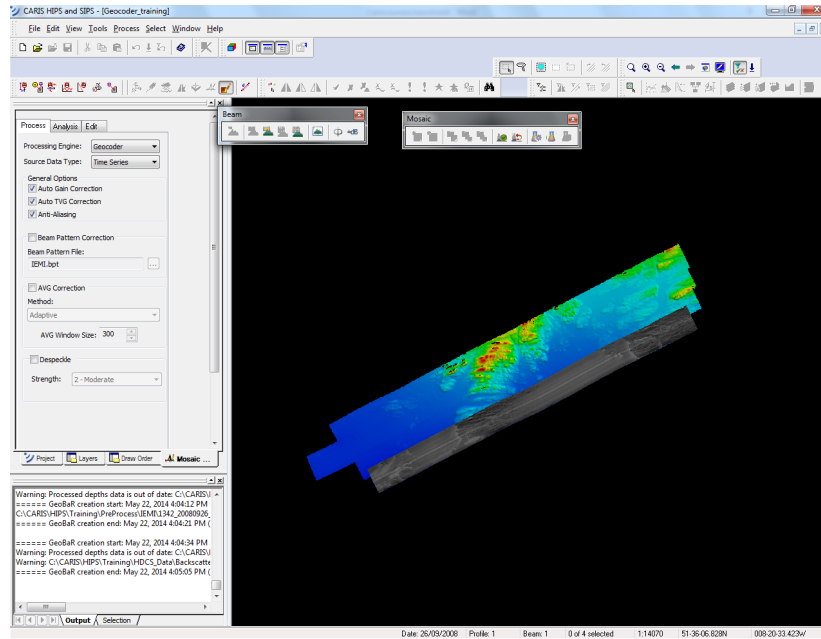

Figure 13.5 Create beam pattern.

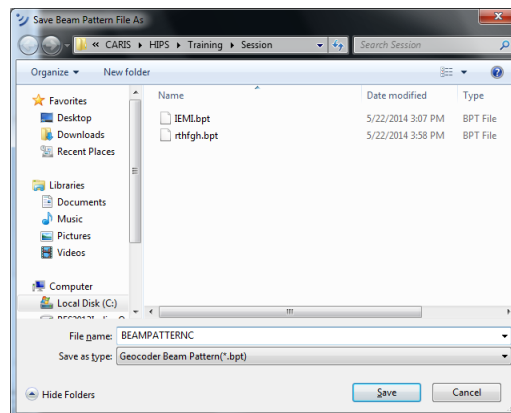

Figure 13.6 Save beam pattern as “bpt” file.

- Create the beam pattern, select in the ‘process’ tab the following (Fig. 13.7):

Processing Engine: Geocoder.

Source Data Type: Time series.

General options to select:

Auto gain correction

Auto TVG correction

Anti-aliasing

Beam pattern correction and select the ‘bpt’ file that you have created previously.

AVG correction.

Method: Adaptive.

AVG window Size: 300.

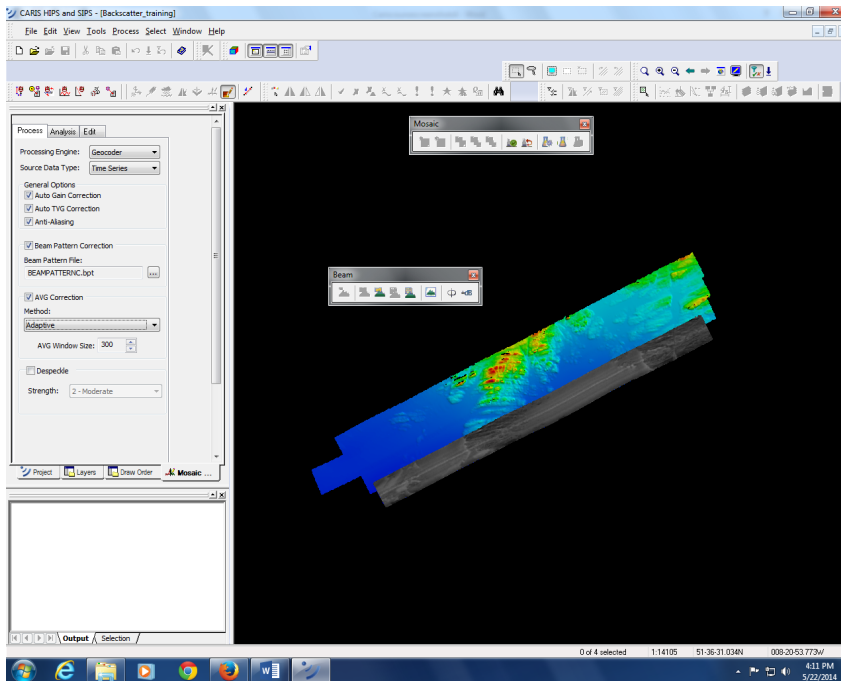

Figure 13.7 Select processing options.

- Select all lines (Ctrl + A) and 'create GeoBar for all lines' (It is recommendable the next name to create GeoBar lines GeoBar_resolution_%I) to apply the beam pattern correction file (Fig. 13.8).

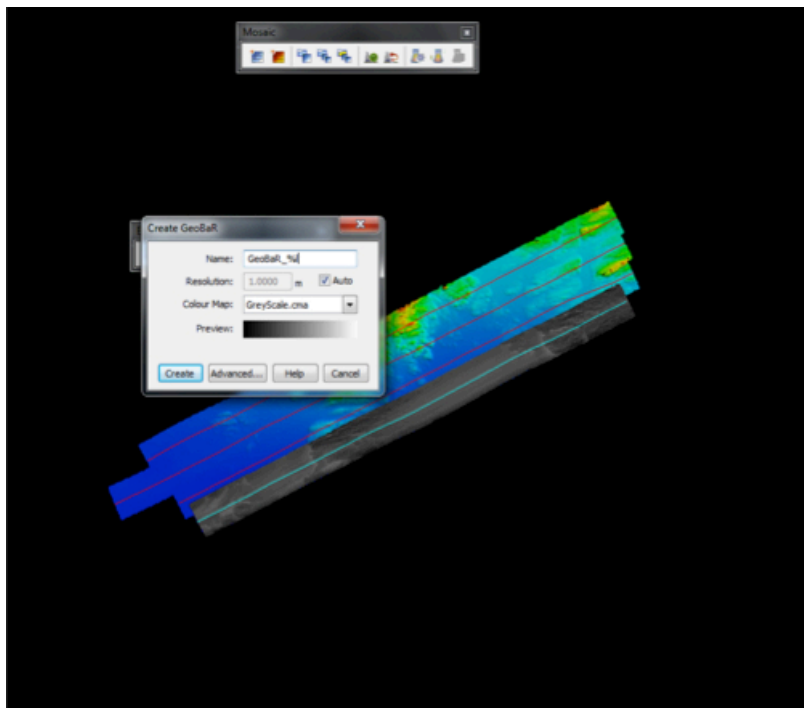

Figure 13.8 Applying GeoBars to all lines. The resolution is the same for all lines.

Once all GeoBar lines have been created, you can modify the GeoBar lines. These can be edited in the following way:

- Select a GeoBar line and go to the 'mosaic editor' window to take the 'edit' tab. In this tab, you can move the 'brightness' and 'contrast' bars to adjust them. Do that next with the rest of the lines, or leave everything like it. The last step is to make the desired mosaic with all the track lines for which GeoBars have been created.
- Go to the 'mosaic' toolbar (or in tools, mosaic editor and create a mosaic) and click 'create mosaic'.
- Put the name, the desired resolution (it is recommendable to put the same resolution of its component GeoBars) in meters and select the method 'Full blend'. The color map can also be modified if you want (Fig. 13.9).

If the field sheet is not selected, the mosaic will not be created (do not worry, I normally forget that).

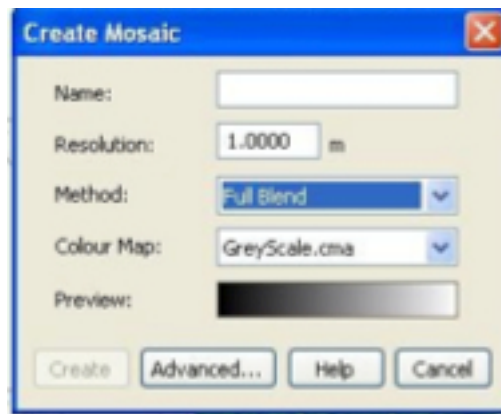

Figure 13.9 Create mosaic.

The final mosaic is shown in Fig. 13.10.

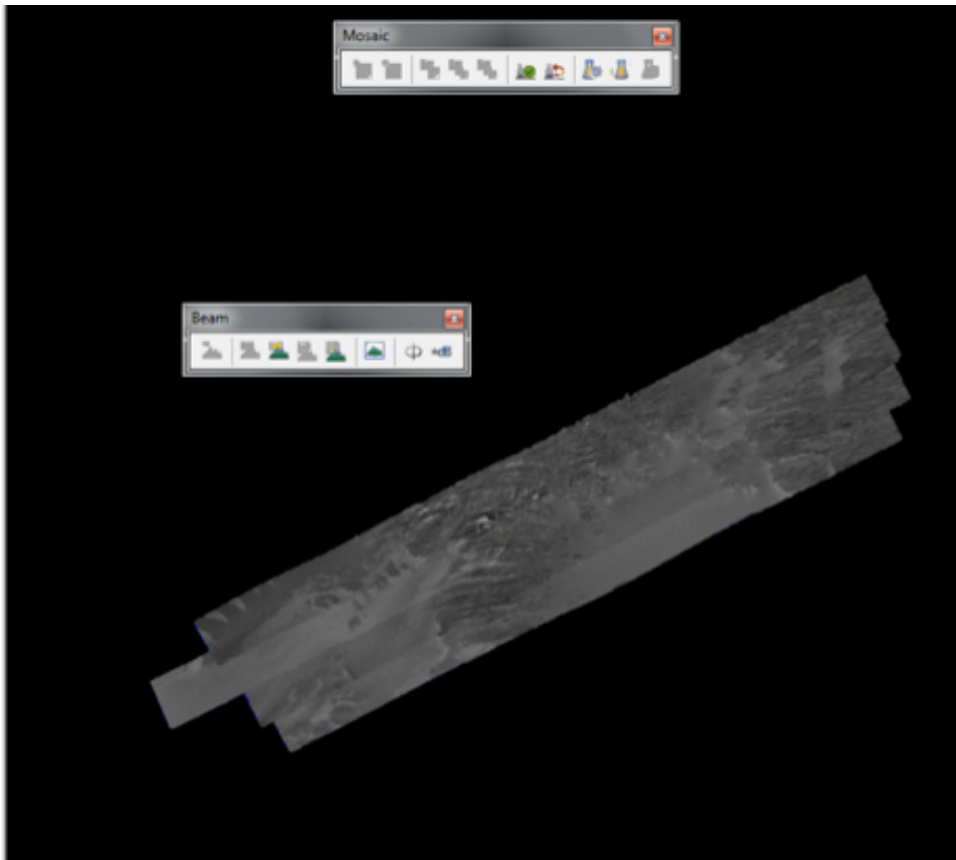

Figure 13.10 Final mosaic.

Once the pretty mosaic is created, it is also possible to conduct image classification (*see point 13.3*) and compare collected samples from the seafloor in the zone with the sediment analysis obtained in the program, by selecting Geocoder (*see point 13.2*).

Concepts to take into account:

It is necessary to divide the area where we want to work in segments. Segmentation means to study and analyze the area and take samples where the seafloor is different (regions of consistent acoustic return type). If it is combined physics-based models of how the sound interacts with the seafloor and radiometric and geometric corrections factors (**Geocoder** engine is the software tool that was used to conduct geometric and radiometric corrections), it is possible to analyze the sediments (i.e., deduce the grain size). Nevertheless, you must not forget other variables that influence and vary the result (used frequency, angular response, grazing angle, attenuation, calibration, gain settings, pulse length, beam pattern, software changes, temporal changes, etc.).

The slant range correction reduces the measured time series to depict the image (flat seafloor assumption).

Beam Pattern correction corrects extreme pixel intensities in the swath angle, on both sides from nadir (i.e., it eliminates sediment artifacts).

Angle varying Gain correction removes angular gain artifacts from the imagery in according with seafloor physical properties.

Full blend method computes the mean of those pixels that overlap. That is the reason why the more overlap between lines, the better result you will have.

Despeckle is used when there are isolated pixels with intensity levels that are different from the neighboring pixels, by removing the extreme values, but its abuse can give rise to detrimental imagery.

13.1.2 Steps to get an advanced reflectivity mosaic, by analyzing the sediments

This is a step forward from the previous step. This process tries to explain, in the best possible way, how to carry out the sediment analysis of a specific area (Figs. 3.11, 13.12, and 3.13), which is totally independent of the pretty mosaic made previously.

Is it possible to work with the GeoBars obtained in the pretty mosaic conducted previously? The answer to this question is 'yes', but it is better to work with the GeoBars directly, line by line. The result would be much better because you work line by line with the real samples from the seafloor.

The goal in this point is to carry out an exhaustive analysis of the angular response received from all beams when it is recorded multibeam backscatter data in a specific area. It is a very tedious task, because you initially compare the collected samples from the seafloor with the obtained results in the "CARIS HIPS & SIPS" program. Those points where the model does not match with the real sample, you will have to edit, by indicating the real morphology of the seafloor. The initial result of the model depends on many variables, as it was explained previously. The model will show better results when the coverage during the survey is 200 % (i.e. overlap between lines 100 %), the vessel reduces speed, among other things.

In this step, you will analyze the sediments line by line exhaustively, by comparing and analyzing your result with all collected samples in the specific area. The more samples you take from the seafloor, the better for the result. Therefore, a wide variety of samples of the specific area are required to perform this tedious step.

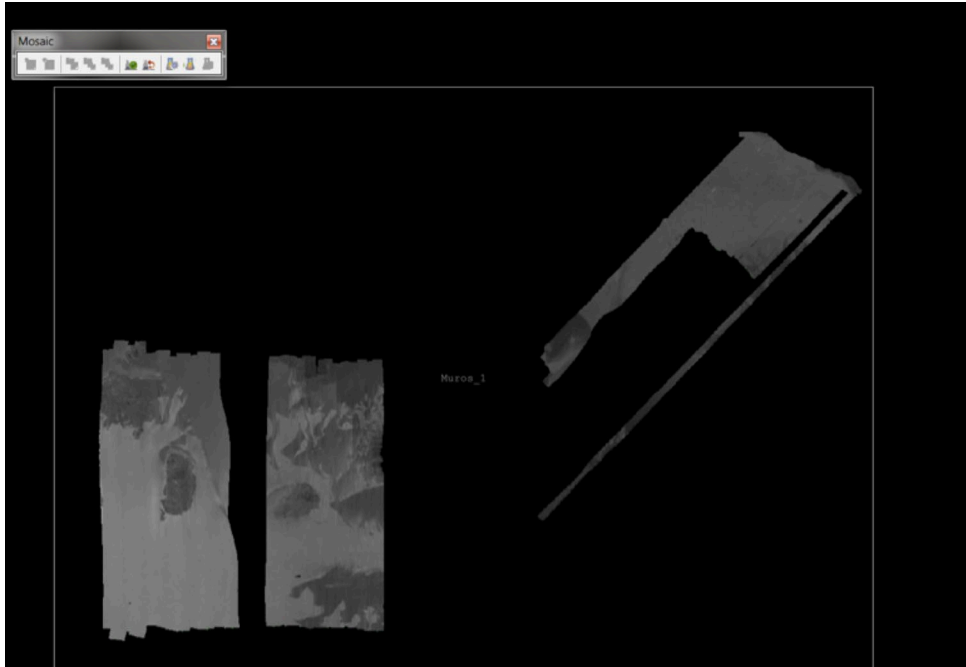

Figure 13.11 Example of a general area.



Figure 13.12 Selected zone in the general area to analyze sediments.

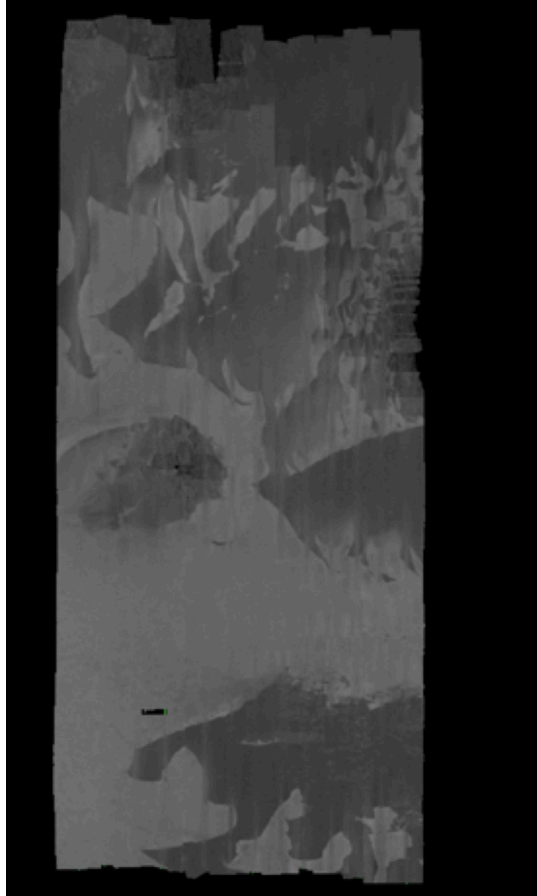

Figure 13.13 Enlargement of selected Zone.

Possible steps to analyze sediments are the following:

- Either work with the pretty mosaic created as the previous step, or create GeoBars line by line.

To get better results, a second option is better. So, the steps to perform this option follow:

- Create a field sheet (indicated by a red circle in Fig. 13.14) of the selected area.

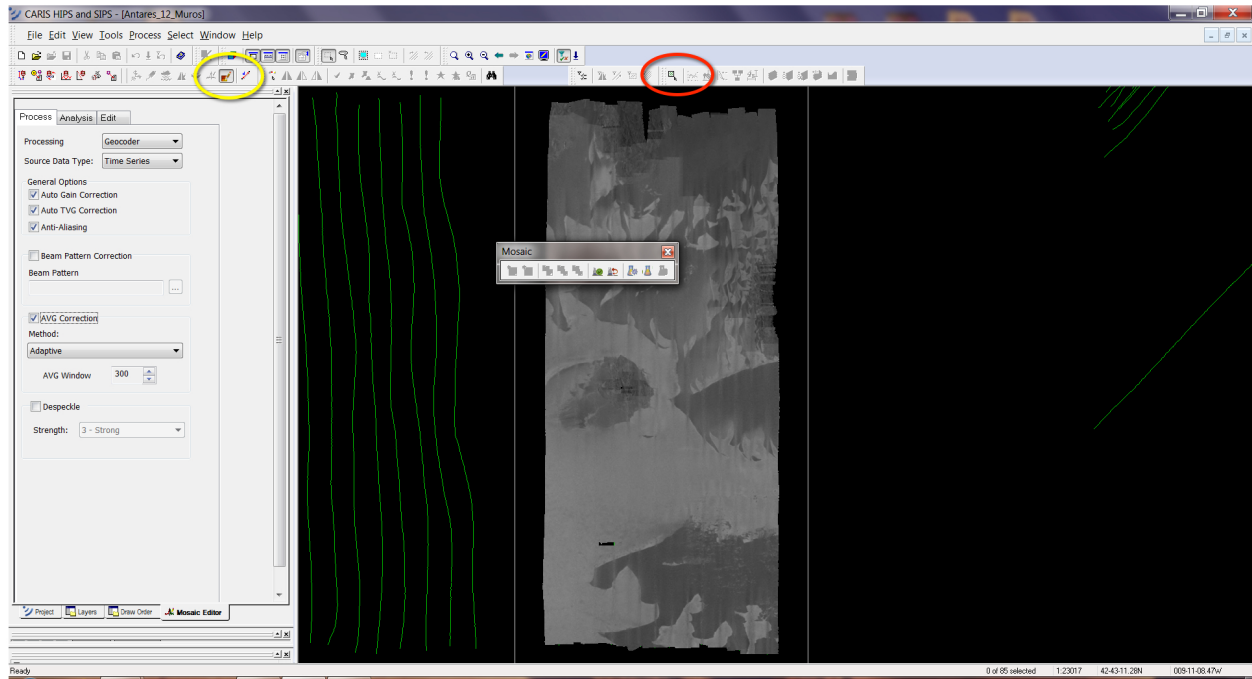

Figure 13.14 Parameters to select in the ‘process’ tab of the ‘mosaic editor’ window- creating a field sheet (red circle), and opening the mosaic “mosaic editor” window (yellow circle).

- Be sure that in ‘Layers’ window, ‘Ship track lines’ is active.
- If you do not have the ‘mosaic’ toolbar (indicated with a yellow circle in Fig. 13.14) in your display, open it.
- Select the line or lines to be analyzed with the mouse and click ‘Load a single GeoBar for selected track line’ or the lines that you want to select "Load all GeoBars for selected track line" (it is recommendable that the analysis be conducted line by line to compare the collected samples with the result of the model and edit in those places where the comparison does not match) (see Fig. 13.15).

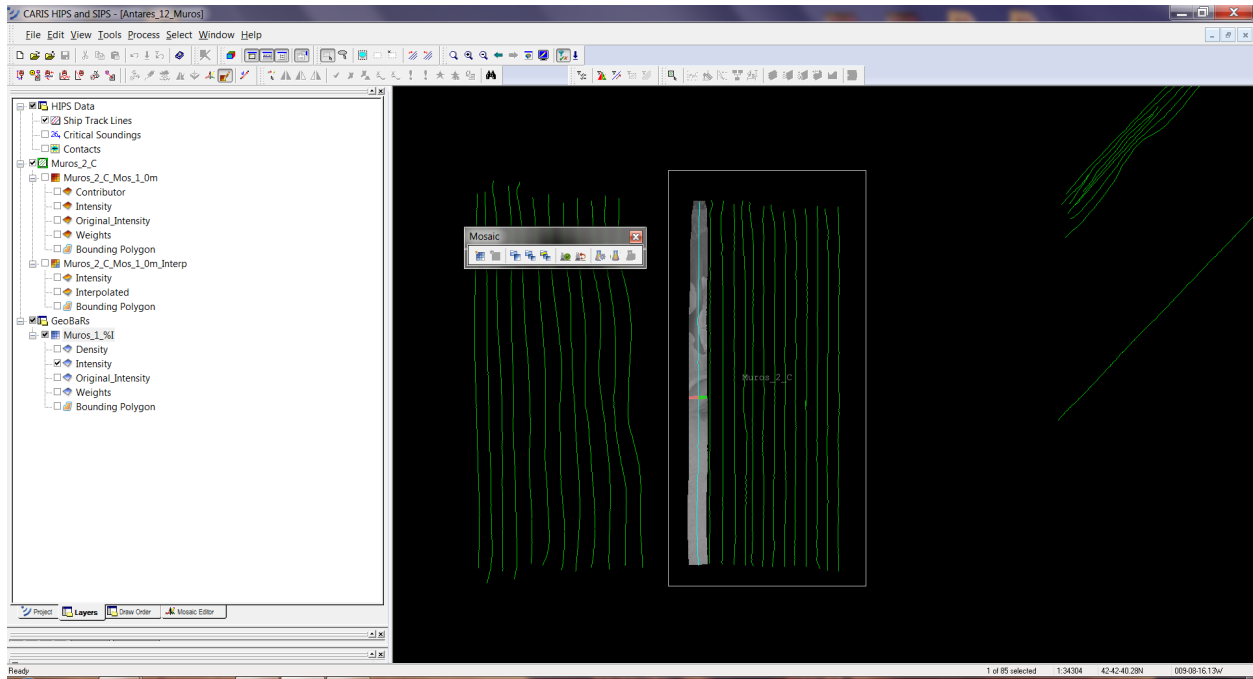

Figure 13.15 Selection of line to be analyzed.

- Go to the ‘Mosaic editor’ window and review in the ‘process’ tab that is selected all the things indicated in Fig. 13.16.

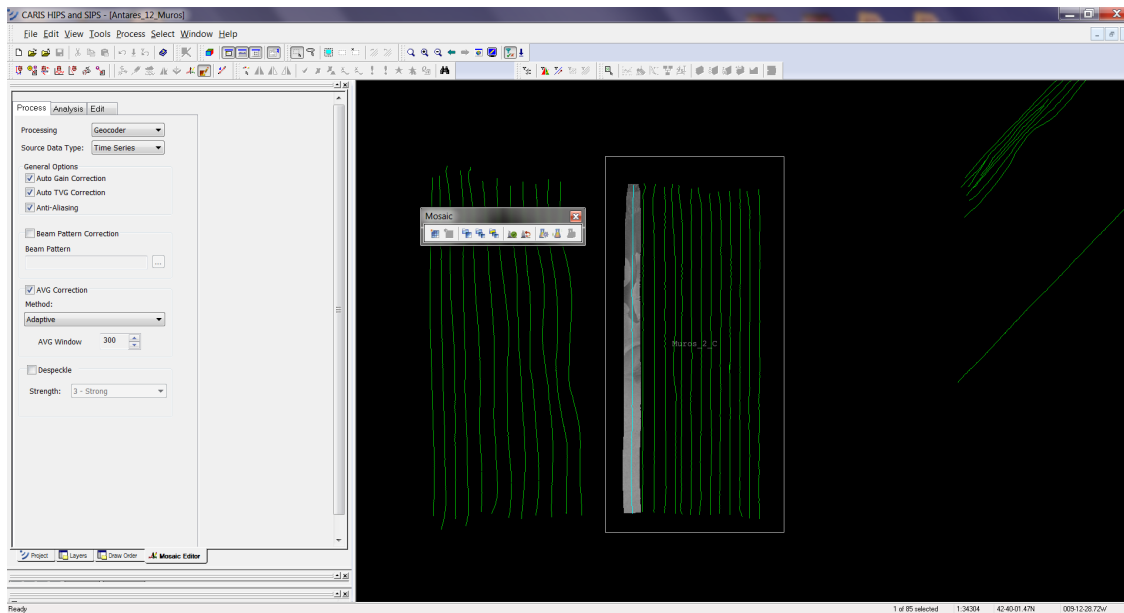

Figure 13.16 Parameters of the process tab in the mosaic editor window.

- Now, select the ‘analysis’ tab and make sure that you select all the things indicated in Fig. 13.17. Be sure that the line is selected and press the button ‘analyze’ to analyze sediments.

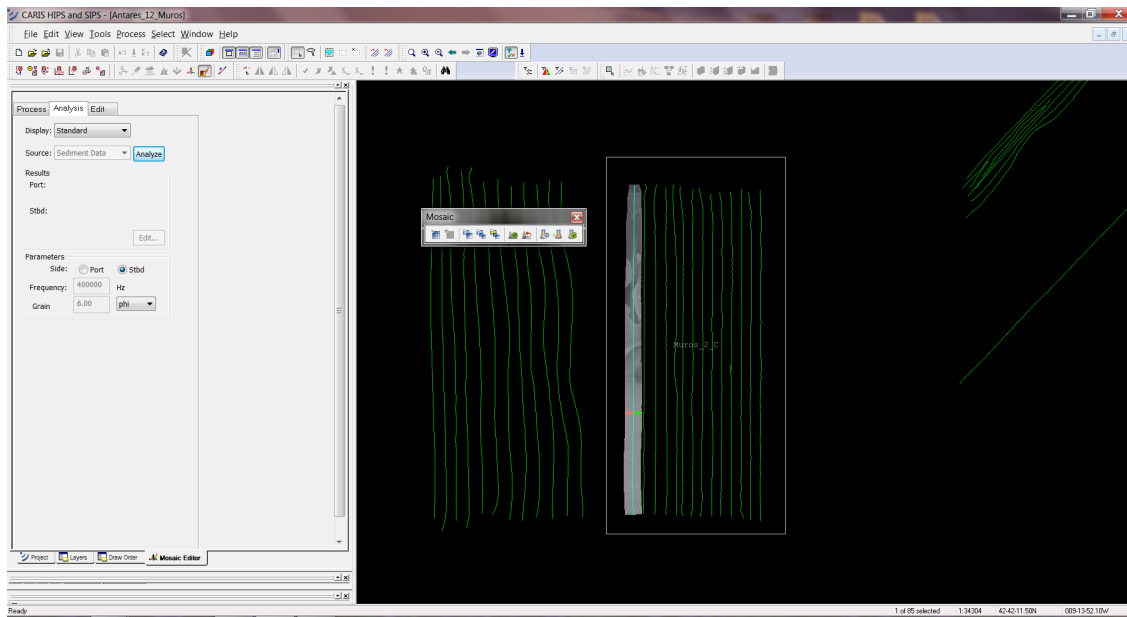

Figure 13.17 Parameters of the analysis tab in the mosaic editor window.

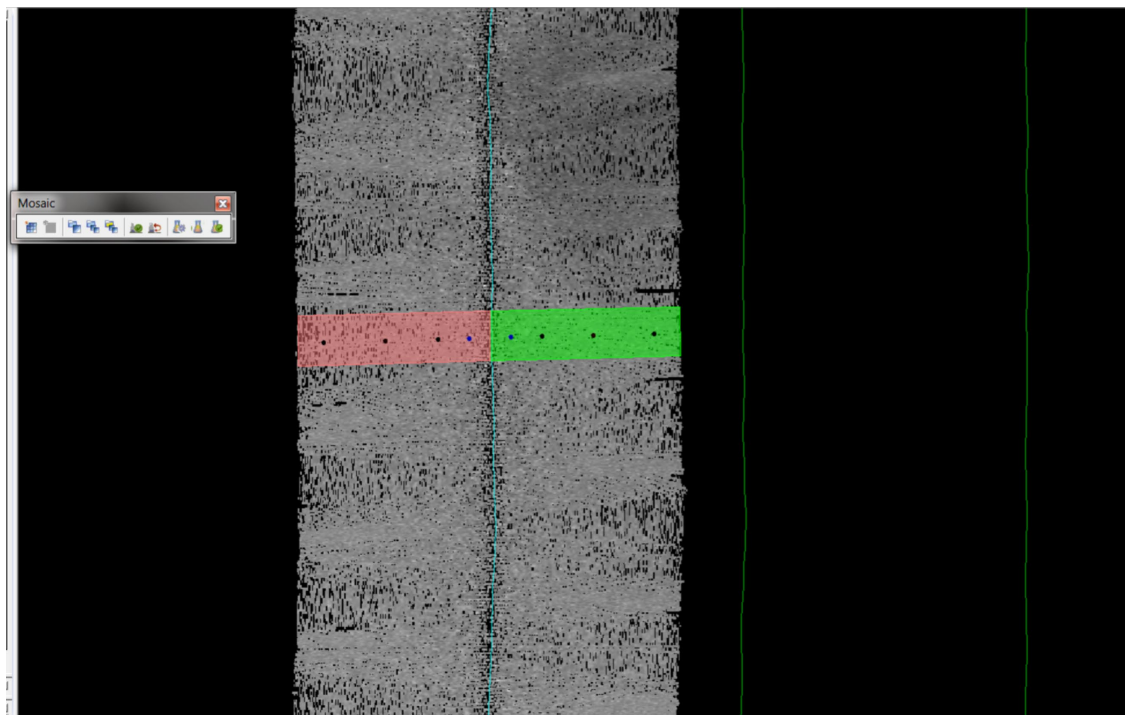

Figure 13.18 Image after pressing “analyze” button. Each point, from centerline to both sides, represents grain size, roughness, volume backscatter, and impedance.

Then, in the ‘Mosaic’ toolbar, do the following:

- First of all, press the button (from right to left) ‘auto analyze file’, secondly the button ‘open the sediment analysis graph’ and finally the button ‘sediment analysis options’. After pressing the last button, select what is indicated in the next figure.

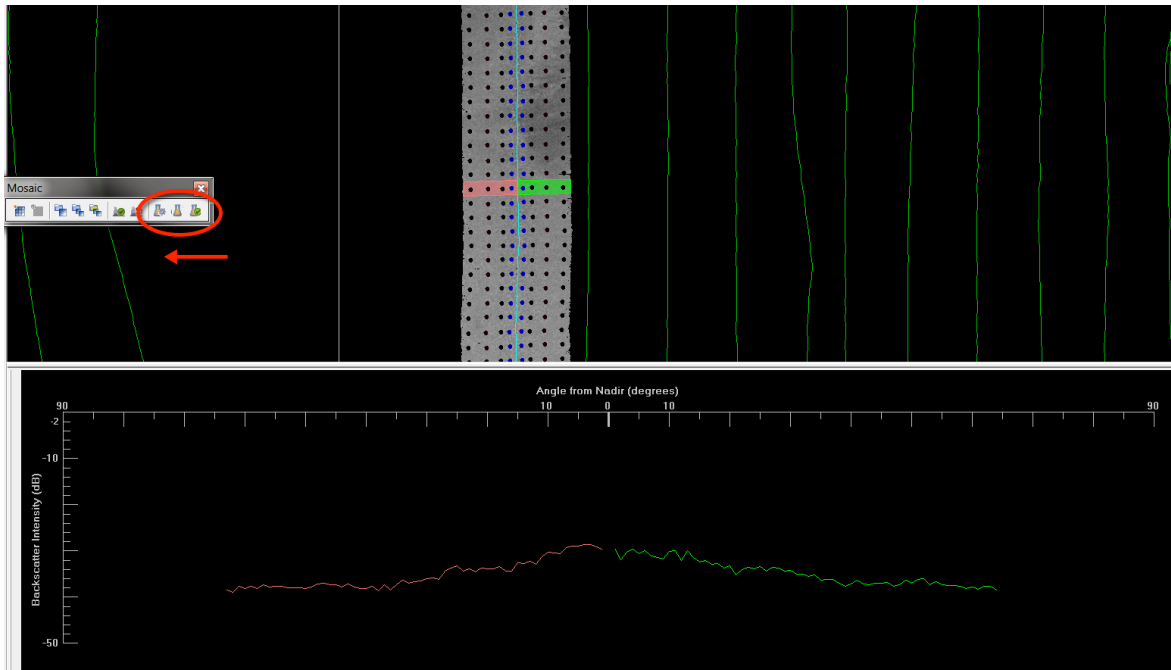

Figure 13.19 Illustration of output.

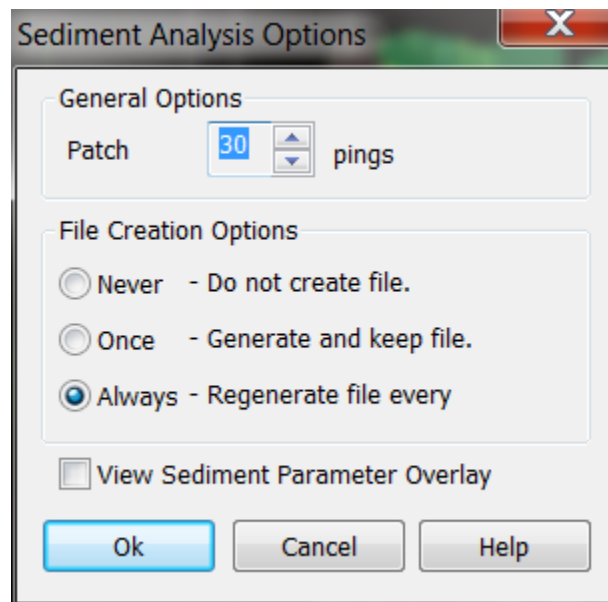

Figure 13.20 Sediment analysis options.

- Pressing the left button of the mouse on the track line you can see the information by snippets.

-
- To see the expected graphic with the lines of roughness, Kirchhoff, volume backscattering and grain size, you need to go the 'analysis' tab and in "display" select the option "advanced" (Fig. 13.21). Then, press "graphic options" in order to select everything as it is indicated in Fig. 13.22.

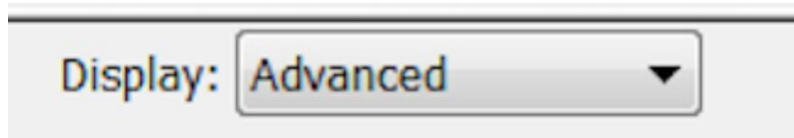

Figure 13.21 Advanced button.

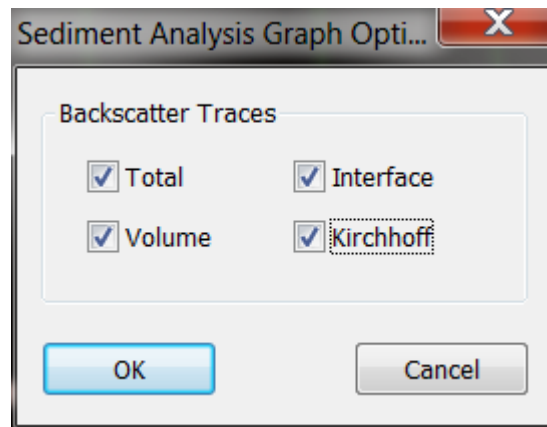

Figure 13.22 Sediment analysis graph options.

You are now ready to see the results of the angular response analysis (ARA). ARA is a model that uses the angular dependence of backscatter to predict seafloor properties. Figure 13.23 shows different results of the model. Are they good?

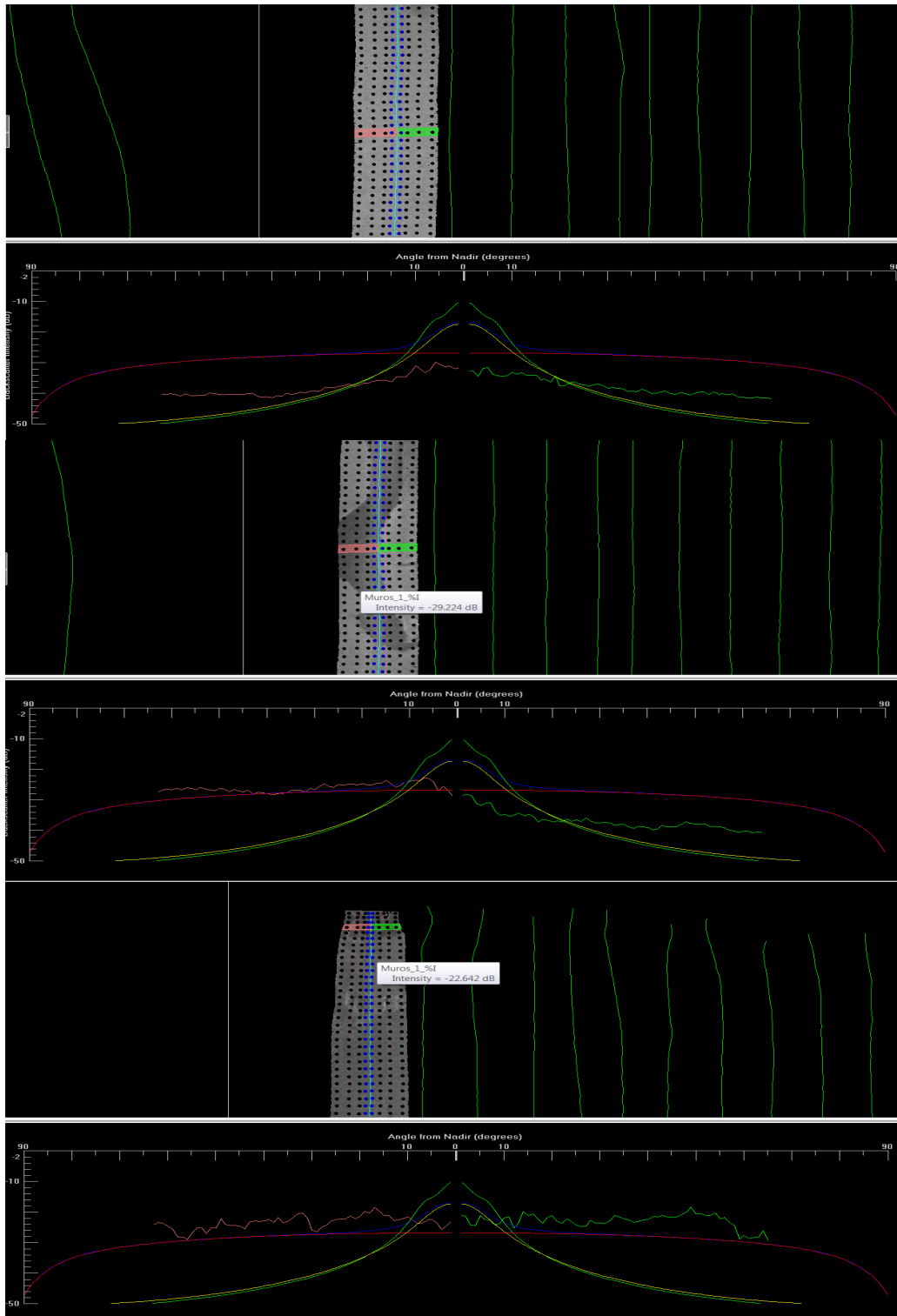

Figure 13.23 Three different zones of the same line, showing differences obtainable by analyzing the sediments with the model.

The green line indicates impedance.

The yellow line indicates the roughness.

The red line indicates the volume backscatter.

The blue line is the result of the other lines and it indicates the grain size.

To answer to the previous question is necessary to go directly to the points where we have real samples to compare it. It is probable that the result will not be good. So, what to do?

- Select the 'analysis' tab and select the following:

Display: advanced.

Source: sediment data.

Results: Click 'edit' (make sure that you are over the sample point) and select the grain size that you took and click 'insert' (Fig. 13.24).

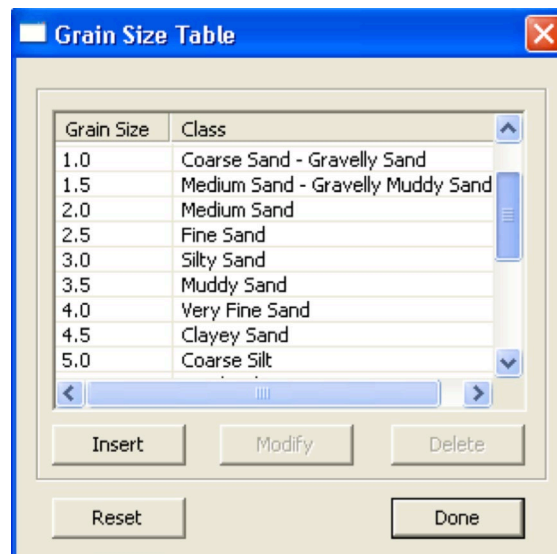

Figure 13.24 Grain size table.

The more samples you have, the better result you will have because you are introducing real values to the model.

When you analyze the sediments of your specific area you will see values from 0 to 1, by indicating the class and the grain size (Fig. 13.25). Those values that are below 0.4 are theoretically considered as very good. The larger the value, the worse it is.

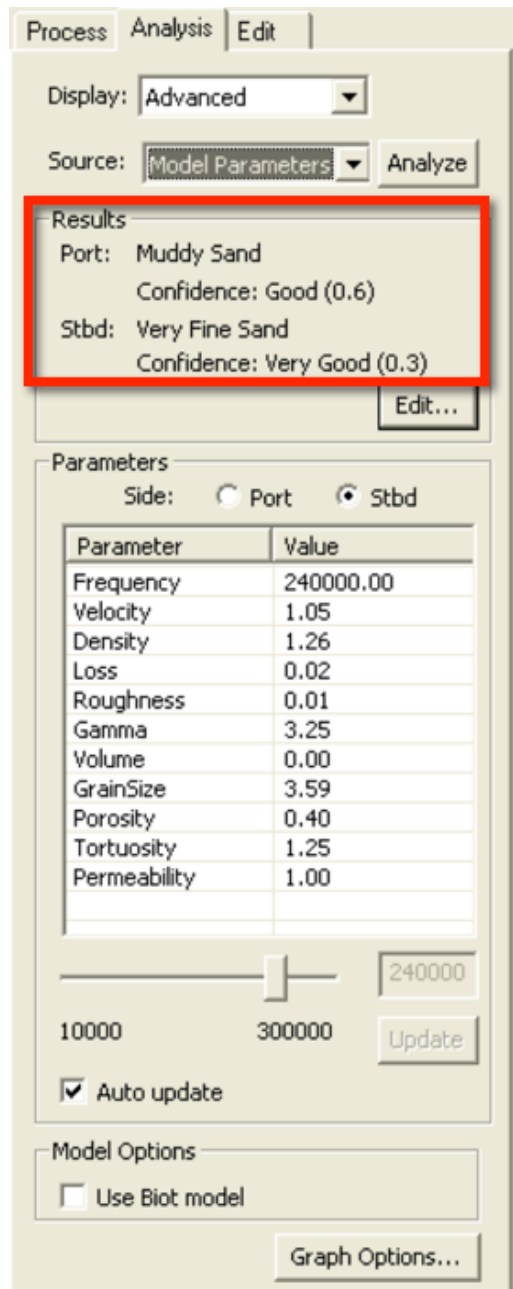

Figure 13.25 Class and grain size.

Once you finish your valuable work, you can get a classification of the mosaic. How to do that? It is easier than the previous steps.

- Right click on your selected mosaic layer and click 'classify' (Fig. 13.26).

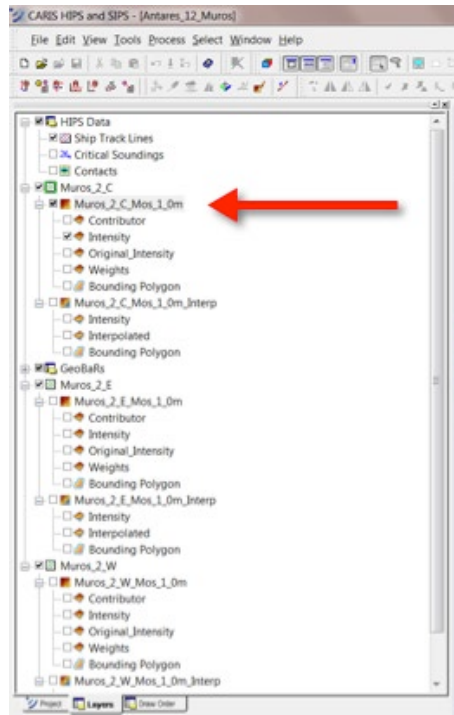

Figure 13.26 Select mosaic layer to classify.

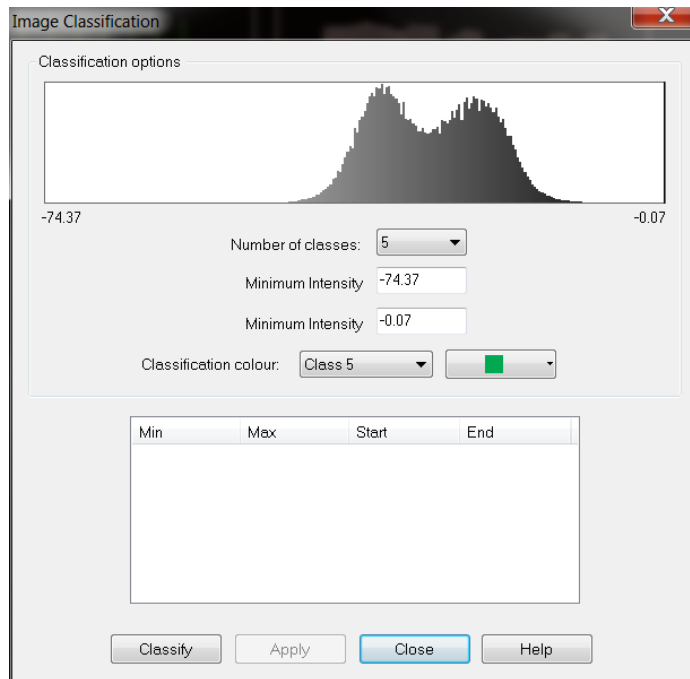

Figure 13.27 Classification options.

- Select the number of classes and the classification color for each class (Fig. 13.27). You can conduct the classification with the intensity if you want.

- If the result is not the expected result because you consider that the image classification requires more number of classes, change the parameters. You have the option of clicking on the Mosaic intensity layer and go to properties window (general, color file) to change the color file if you have more than one, edit (add or remove colors) or even create a new one.
- When you are pleased with the results, click 'apply' (Fig. 13.28) and save the crf file (Fig. 13.29).
- Click 'close' and finally click with the middle mouse within the display window to refresh the display. The classification will be applied to the mosaic (Fig. 13.30).

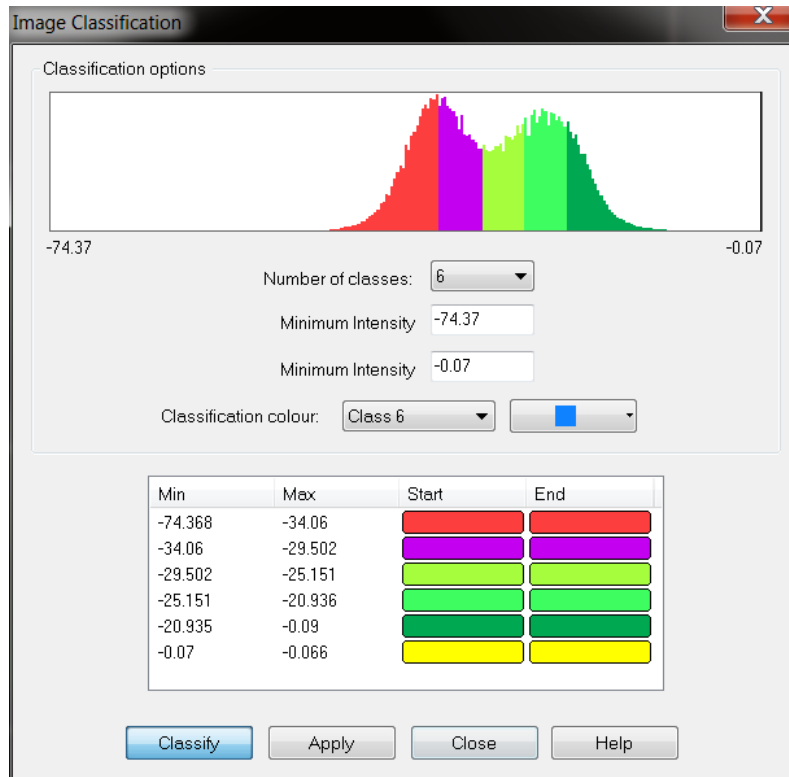

Figure 13.28 Apply classification options.

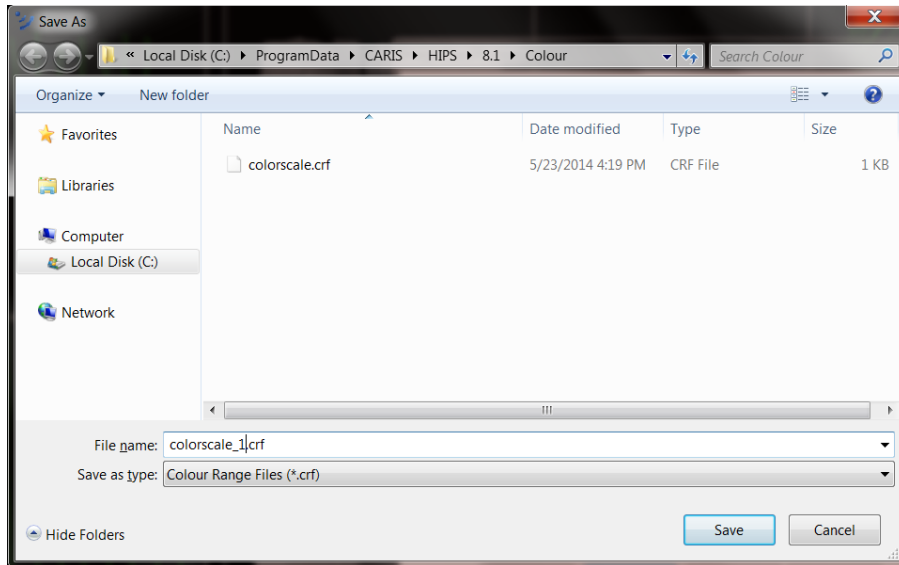

Figure 13.29 Save crf file.



Figure 13.30 Image classification.

Is it possible to conduct this image classification in the step 1 when conducting the pretty mosaic? The answer to this question is 'yes'. It is always possible to do it when you have mosaic

layers. Once you create one mosaic layer, you can do it or even interpolate the mosaic to obtain another one (Fig. 13.31).

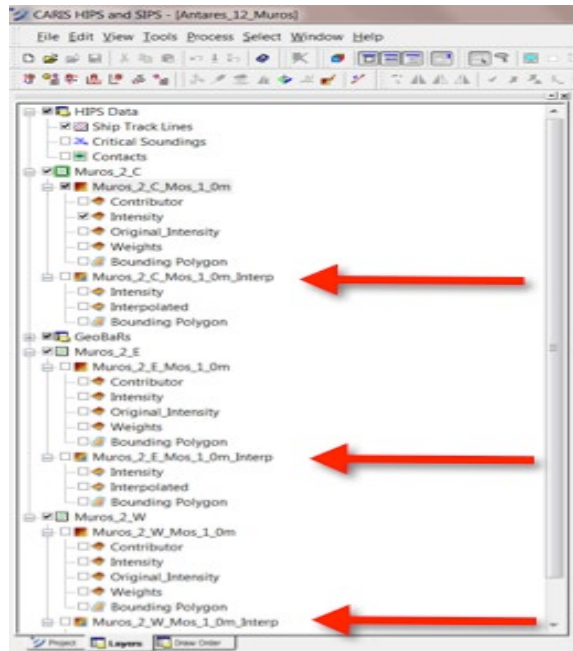

Figure 13.31 Examples of created interpolation mosaics.

13.1.3 Image classification

Once you create a mosaic, you can get a classification of it.

- Right click on your elected mosaic layer and click 'classify' (Fig. 13.32).



Figure 13.32 Classify mosaic layer.

- Select the number of classes and the classification color for each class. You can conduct the classification with the intensity if you want (Fig. 13.33).
- If the result is not the expected result because you consider that the image classification requires more number of classes, change the parameters. You have the option of clicking on the Mosaic intensity layer and go to properties window (general, color file) to change the color file if you have more than one, edit (add or remove colors) or even create a new one.
- When you are pleased with the results, click 'apply' (Fig. 13.33) and save the crf file (Fig. 13.34).
- Click 'close' and finally click with the middle mouse within the display window to refresh the display. The classification will be applied to the mosaic (Fig. 13.36).

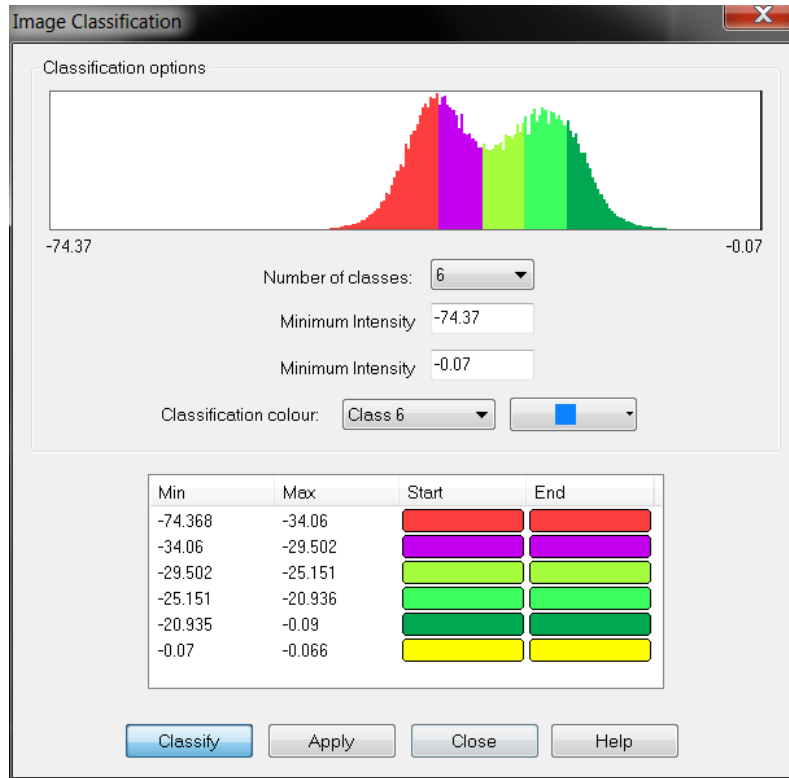

Figure 13.33 Classification with intensity.

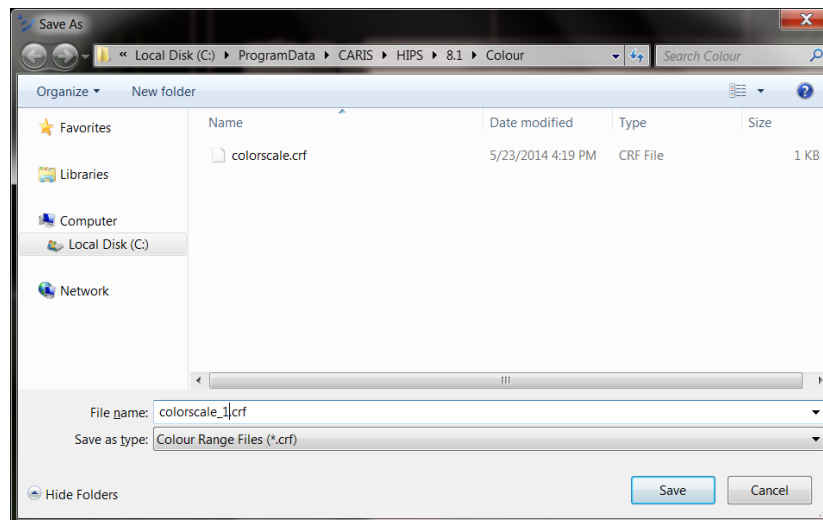

Figure 13.34 Save crf file.

The result that you can obtain is similar to Figures 13.35 and 13.36.

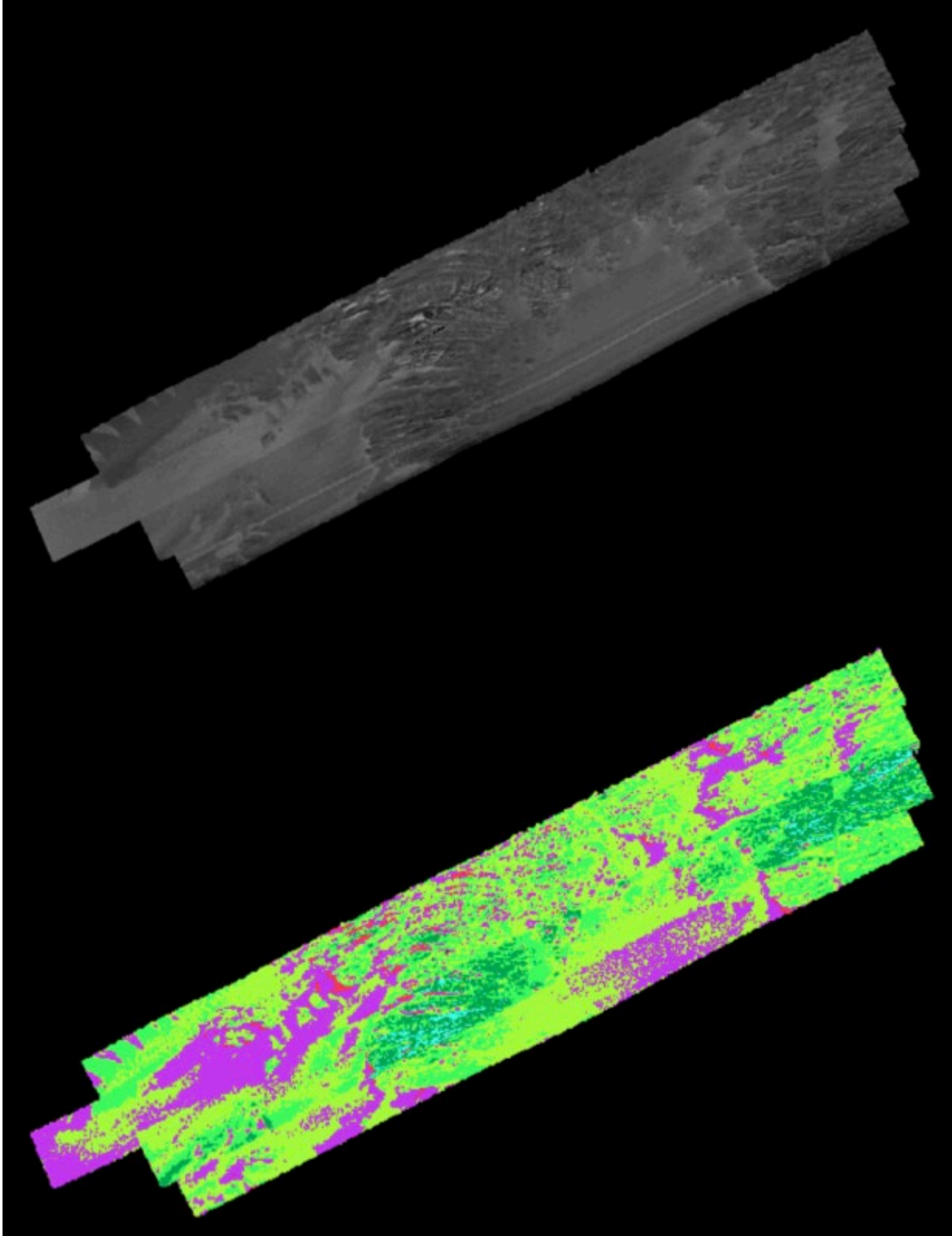

Figure 13.35 Mosaic and classification image from step 1.

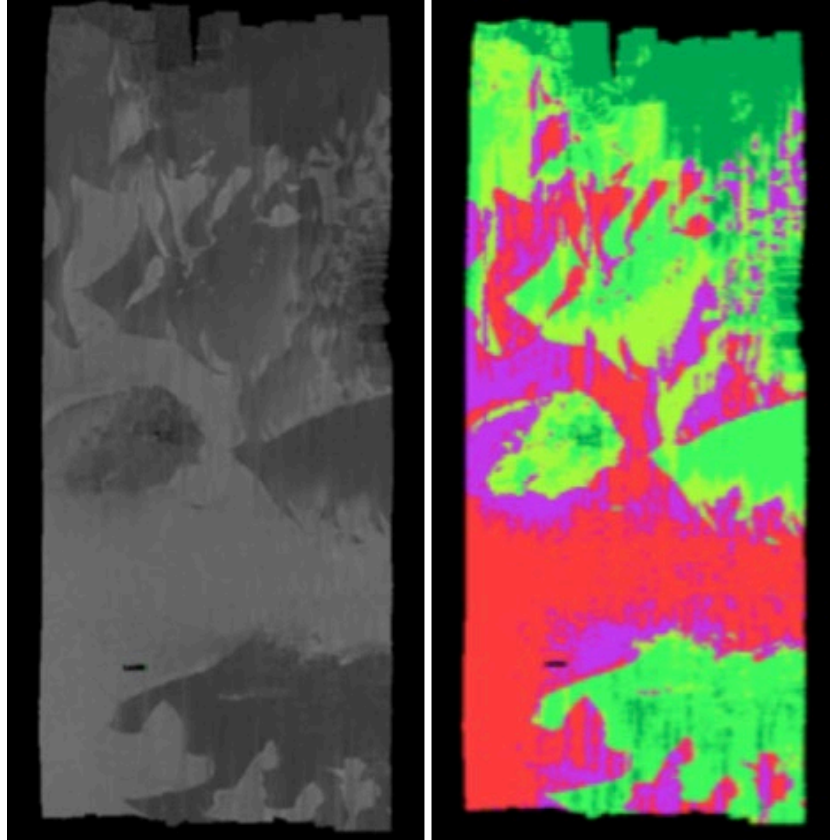

Figure 13.36 Mosaic and image classification from step 1.

13.1.4 Print out the analysis of sediments conducted, on the line or lines selected and analyzed

The steps to conduct it are as follows:

- Select 'file', 'export', 'export wizard', 'select sediment analysis to ASCII' (Fig. 13.3), and electing from the list (*) those interesting parameters (Fig. 13.38).

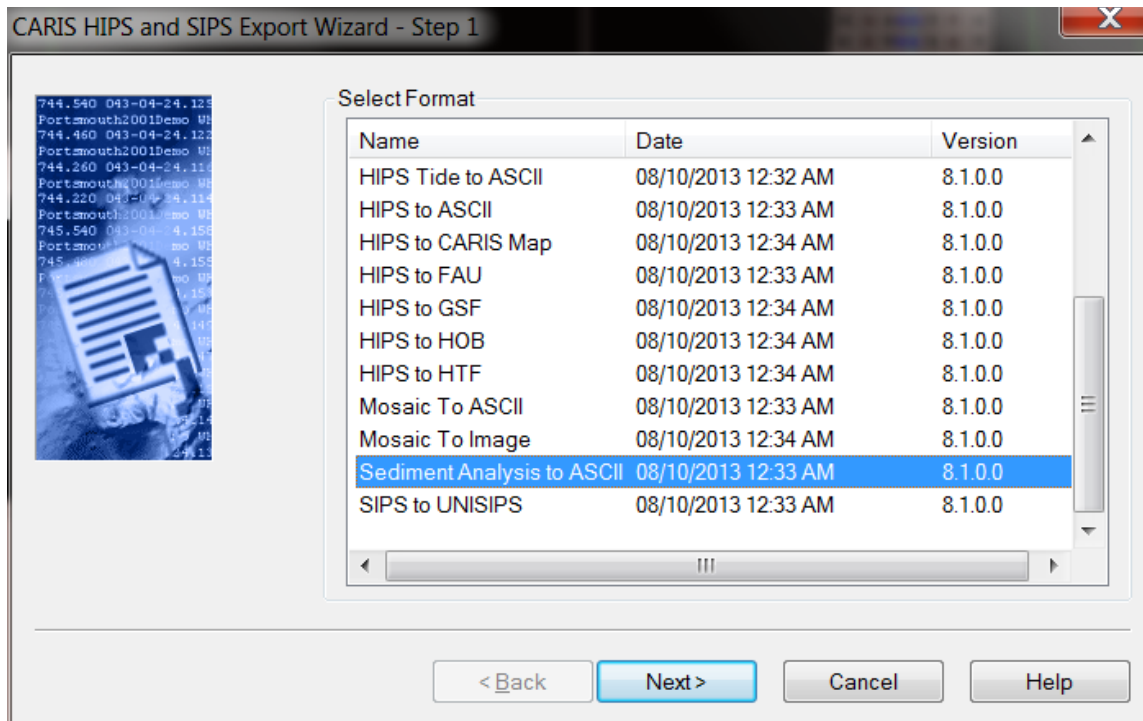

Figure 13.37 Select data in ASCII format.

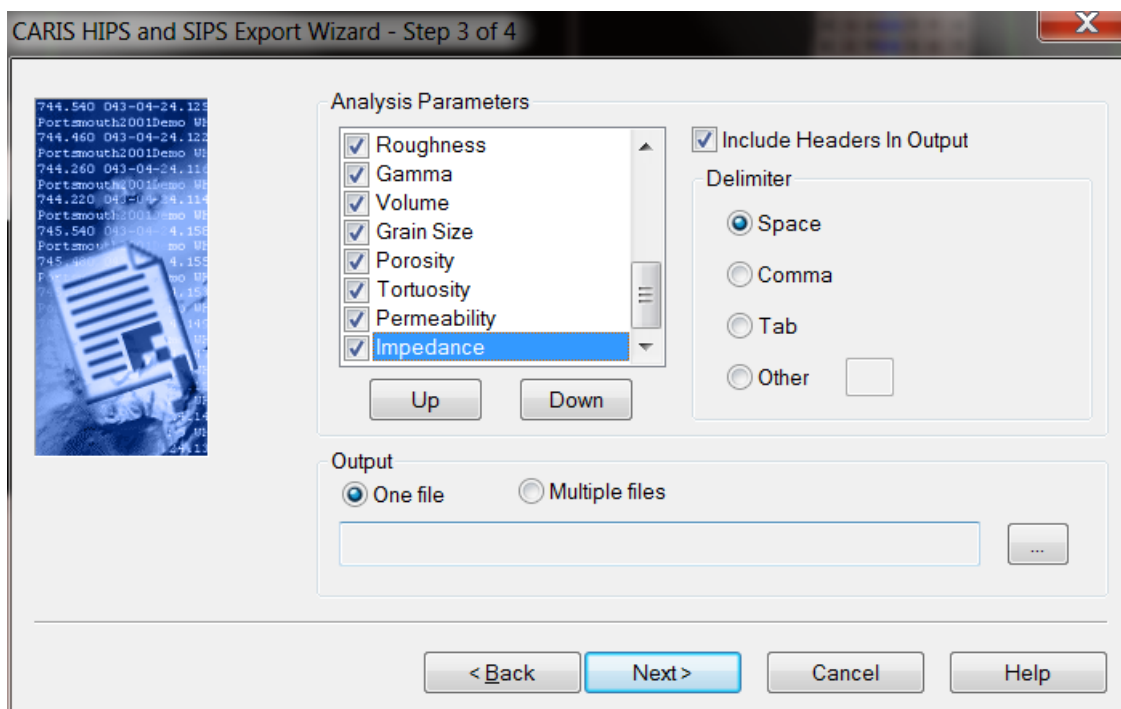

Figure 13.38 List of parameters.

(*) The complete list that appears in the Fig. 13.38 is the following:

Line name, side, **sediment type**, **confidence level**, frequency, sound speed, density, loss, **roughness**, gamma, **volume backscattering**, **grain size**, porosity, tortuosity, permeability and **impedance**.

You will only select those parameters that appear in bold (Fig. 13.39).

Confidence	F//Lat (DD)	Long (DD)	Frequency	Sediment Type	Grain Size	Roughness	Porosity	Tortuosity	Permeability	Impedance
0.3	42.754231356N	009.047459825W	85,000	COARSE SILT	4.87	0.011929200243948	0.4	1.25	1	1.18103210961662
0.3	42.739315758N	009.067046245W	85,000	VERY FINE SAND	3.98	0.0030067165157	0.4	1.25	1	1.264486865340863
0.3	42.748058171N	009.052849839W	85,000	COARSE SILT	4.86	0.011929200243948	0.4	1.25	1	1.18189818683172
0.3	42.750352378N	009.051989881W	85,000	COARSE SILT	4.86	0.011929200243948	0.4	1.25	1	1.18189818683172
0.3	42.751087287N	009.049755724W	85,000	COARSE SILT	4.82	0.011929200243948	0.4	1.25	1	1.18535949986691
0.3	42.754593129N	009.045186286W	85,000	COARSE SILT	4.95	0.011929200243948	0.4	1.25	1	1.17322393408477
0.3	42.755494956N	009.042489047W	85,000	SANDY SILT	5.01	0.011929200243948	0.4	1.25	1	1.18196783696681
0.3	42.748340681N	009.051211085W	85,000	COARSE SILT	4.7	0.011929200243948	0.4	1.25	1	1.23194567696681
0.3	42.746489952N	009.053658572W	85,000	COARSE SILT	4.83	0.011929200243948	0.4	1.25	1	1.17448962098184
0.3	42.745509932N	009.054926754W	85,000	COARSE SILT	4.8	0.011929200243948	0.4	1.25	1	1.29194738694565
0.3	42.727195024N	009.076468735W	85,000	VERY FINE SAND	3.77	0.003843548735831	0.4	1.25	1	1.29194738696681

Figure 13.39 Possible outcome.

Acknowledgments. I would like to thank Professors from the Center for Coastal and Ocean Mapping (CCOM), at the University of New Hampshire, for all their support during my stay there.

13.2 Generation of useful layers and files in a BASE surface to ease data processing with CARIS (Version 9)

13.2.1 How to generate a layer with the total vertical uncertainty (TVU) of the International Hydrographic Organization (IHO) for one specific survey Order

CARIS software allows the hydrographer to generate new layers in a BASE surface easily. These layers help the hydrographer to identify the areas where it is necessary to spend more time processing survey data.

TVU formulas of IHO (at 95% confidence level), in according to the survey Order, are the following:

$$TVU = \left(\pm \sqrt{a^2 + (b \times d)^2} \right)$$

Where:

- “a” represents the part of the error that does not vary with the depth
- “b x d” represents the part of the error that varies with the depth
- “d” is the instantaneous depth

IHO_ORDER_E =	((0.25^2 + ((Depth*0.0075)^2))^0.5)
IHO_ORDER_1 =	((0.5^2 + ((Depth*0.013)^2))^0.5)
IHO_ORDER_2 =	((1.0^2 + ((Depth*0.023)^2))^0.5)

Table 13.1 IHO Orders.

ORDER	Special	1a	1b	2
a	0,125	0,250	0,250	0,300
b	0,004	0,008	0,008	0,010
DEPTH	TVU (95 % CONFIDENCE LEVEL)			
0	0,125	0,250	0,250	0,300
5	0,126	0,253	0,253	0,304
10	0,131	0,261	0,261	0,316
15	0,137	0,274	0,274	0,335
20	0,146	0,292	0,292	0,361
25	0,156	0,313	0,313	0,391
40	0,195	0,391	0,391	0,500
50	0,225	0,451	0,451	0,583
100	-	0,791	0,791	1,044
200	-	-	-	2,022
500				5,009
750				7,506
1000				10,004
1500				15,003
2000				20,002
2500				25,002
3000				30,001
3500				35,001
4000				40,001
4500				45,001
5000				50,001
5500				55,001
6000				60,001
10000				100,000

Table 13.2 Order values.

Right click on the BASE surface where you want to add a new layer.

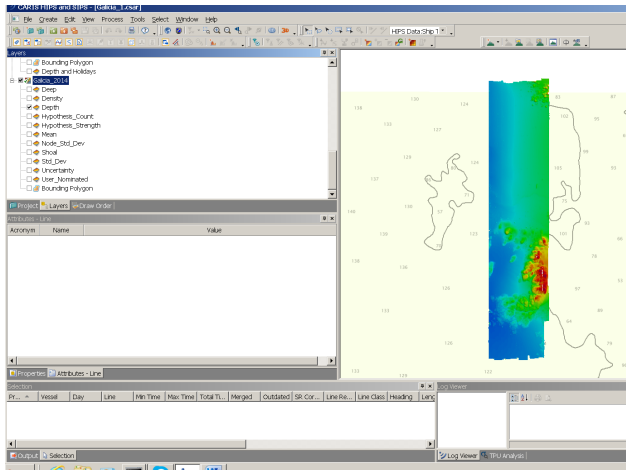

Figure 13.40 BASE layer.

Select < add layer >. You will see a window similar to the window of the next figure. Put the name that you want to the layer and select < Depth with Z-axis positive down >.

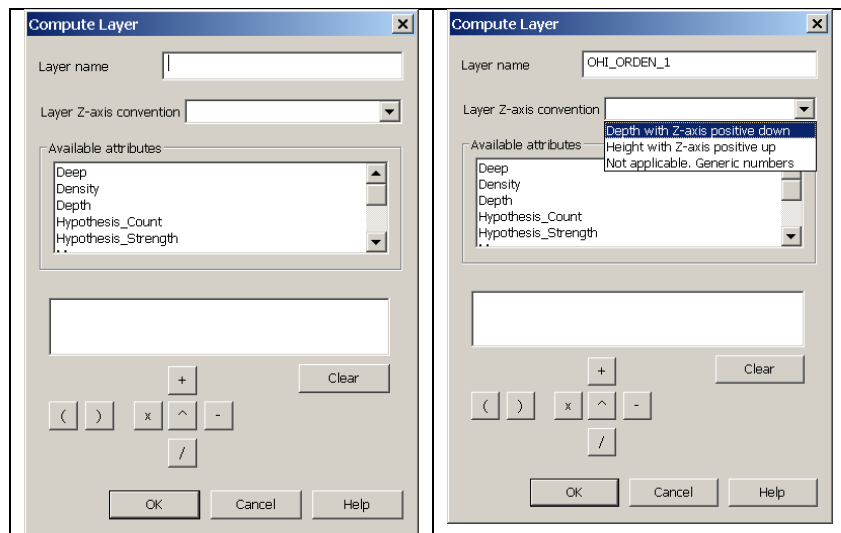

Figure 13.41 Layer Window.

Next step is to add the TVU formula, in according with the survey Order (this example is for an Order 1 survey).

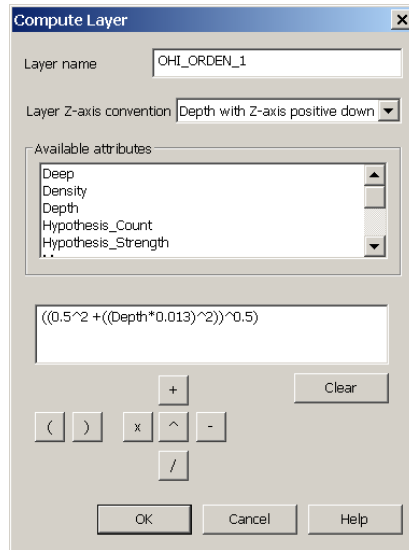

Figure 13.42 Enter TVU formula.

Finally, the layer is generated and it is possible to see, in properties, the minimum and maximum TVU values for selected survey Order. It is also possible to use a filter, in properties, to identify the soundings with high uncertainty values with the goal of editing such data.

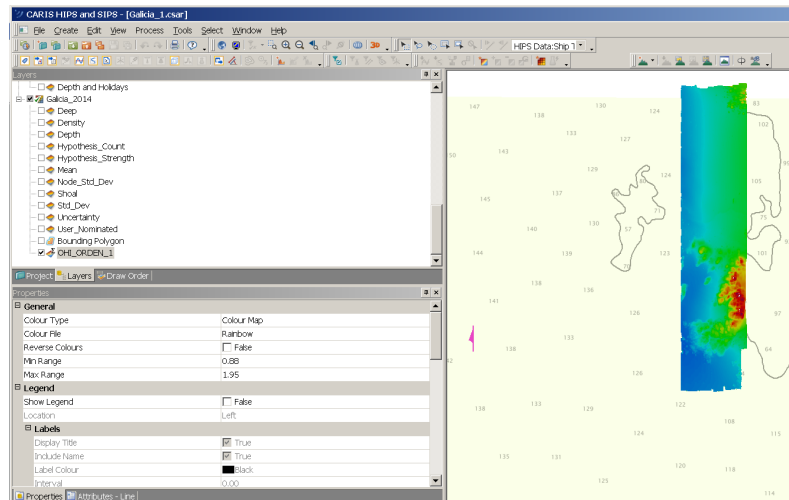

Figure 14.43 Layer with properties displayed.

13.2.2 How to generate a layer showing the proportion between the Uncertainty and the total vertical uncertainty (TVU) of the International Hydrographic Organization (IHO) for one specific survey Order, generated previously

Once TVU layer from IHO is generated, you can make another one to establish the proportion between the Uncertainty layer (layer generated in CARIS for each BASE surface) and the IHO_ORDER_1 layer (layer generated in 13.2.1). This new layer will be very useful for hydrographer to know data quality acquired during the survey.

Uncertainty/IHO_ORDER_E =	$\text{Uncertainty}/((0.25^2 + ((\text{Depth} * 0.0075)^2))^0.5)$
Uncertainty/IHO_ORDER_1 =	$\text{Uncertainty}/((0.5^2 + ((\text{Depth} * 0.013)^2))^0.5)$
Uncertainty/IHO_ORDER_2 =	$\text{Uncertainty}/((1.0^2 + ((\text{Depth} * 0.023)^2))^0.5)$

Table 13.3 New layer generated to know data quality acquired in a survey, in accordance with the survey Order.

Put the name that you want to the layer, select < Depth with Z-axis positive down > and add the proportion in according with the survey Order (this example has used the proportion for a survey Order 1, Figure 13.44).

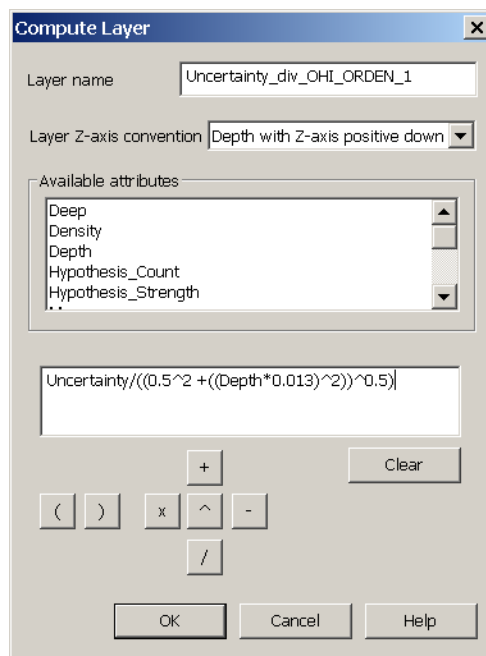

Figure 13.44 Window with survey Order information.

The output will be something similar to Figure 13.45.

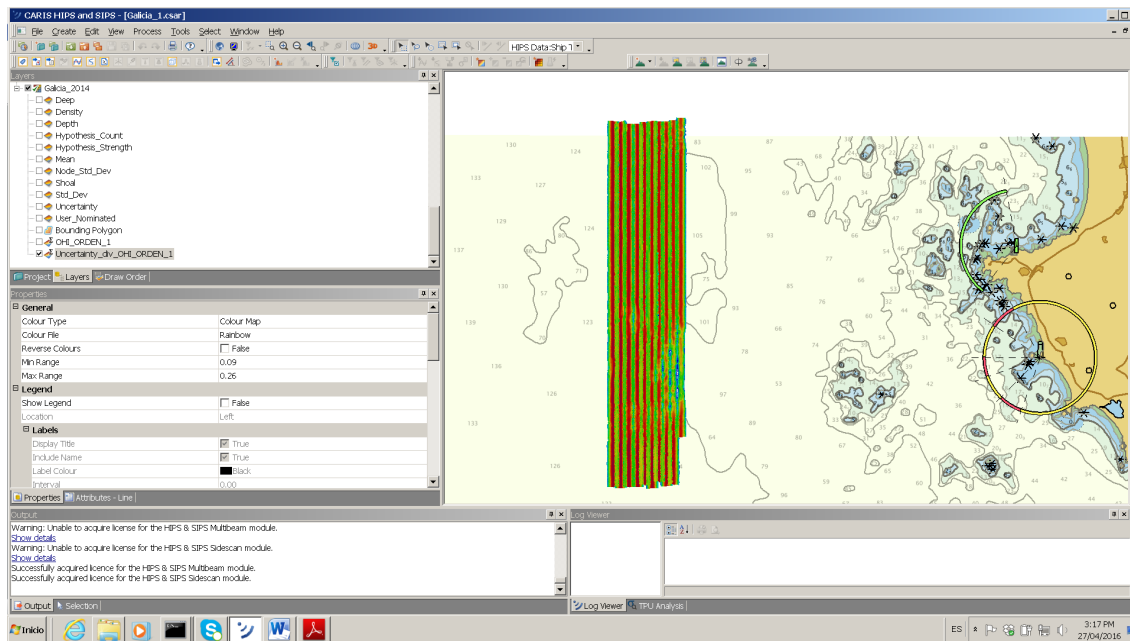

Figure 13.45 Layer with Order information.

In this example (Figure 13.45), the value interval is as follows:

Min Range:	0.09
Max Range:	0.26

Table 13.4 Value interval.

Values obtained must be between 0 and 1. The closer values are to 0, the better.

High quality survey data are near 0 (data obtained with good meteorological conditions, moderate ship speed, high overlapping between survey lines, high updating of sound speed in the water column in accordance with the survey Order, amongst other things). However, it is possible to identify, through filters, where high values of this proportion are, in order to ease the data editing.

Hydrographers should wonder, why are these high values generated? If you get values over 1 in this proportion, this means that uncertainty values obtained are above TVU values allowed by IHO. Therefore, that survey does not comply with minimum standards of IHO, and it would not be reliable.

It is also possible to use a filter for high values, in Properties. Click the filter in properties (it appears as the Word <True> when you activate the filter) and select the minimum and maximum value wished.

Filter	True
Min Val	0.20
Max Val	0.26

Table 13.5 An example to show only the high values with the filter, in properties.

The outcome may be something similar to the next figure.

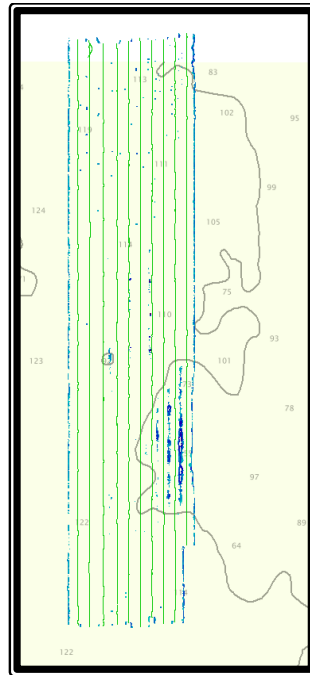

Figure 13.46 Image showing places where hydrographer will have to spend more time editing than in the rest of the survey, mainly in the area below the isobaths of 100 meters.

Needless to say, the Uncertainty layer from the BASE surface and the proportion computed previously depend on uncertainty values used for the system (draft, ship/boat speed, sound speed, tide, zoning, etc.). So, it is necessary to feed the vessel file (hvf file) with the uncertainties of the equipment that takes part of the system (multi beam echo sounder, positioning system, IMU...).

We have studied this specific area like a survey Order 1. It is also possible to study and analyse the same area in order to know whether complies with a minimum standard of a special Order or not. We will check it just now. We will do the same as the previous steps but with the TVU formula of Special Order -- $\rightarrow ((0.250^2 + ((\text{Depth} * 0.00750)^2))^0.5)$.

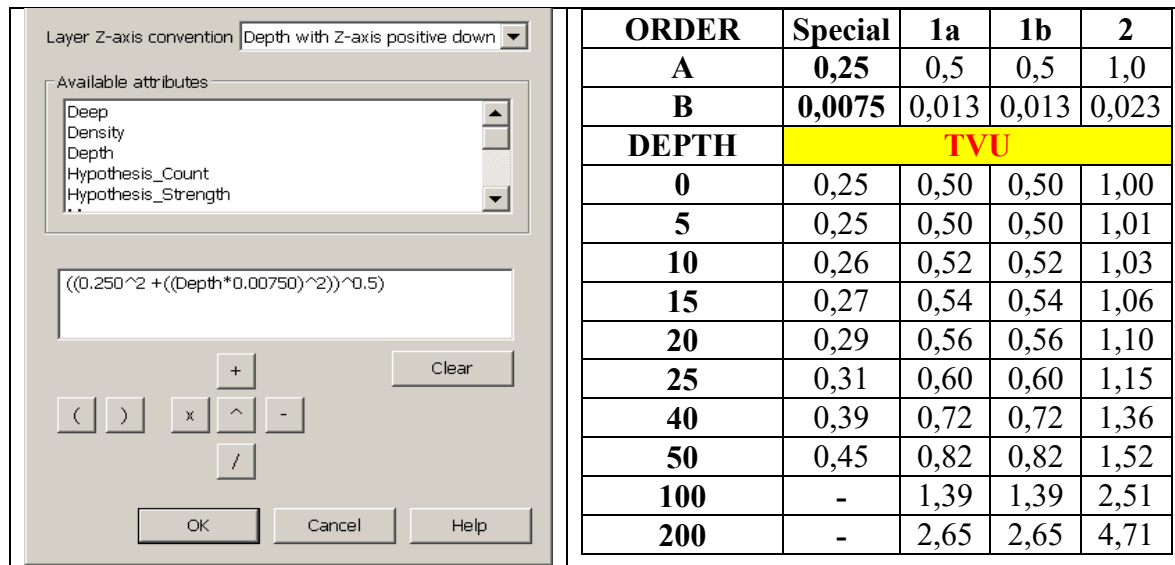

Figure 13.47 Window with Special Order information.

The uncertainty values obtained for this survey, in according with Special Order, are the following:

Min Range:	0.49
Max Range:	1.11

Table 13.6 Uncertainty values.

After that, I generate the proportion between the uncertainty layer and the TVU layer of Special Order from the IHO, as it is indicated in Figure 13.48.

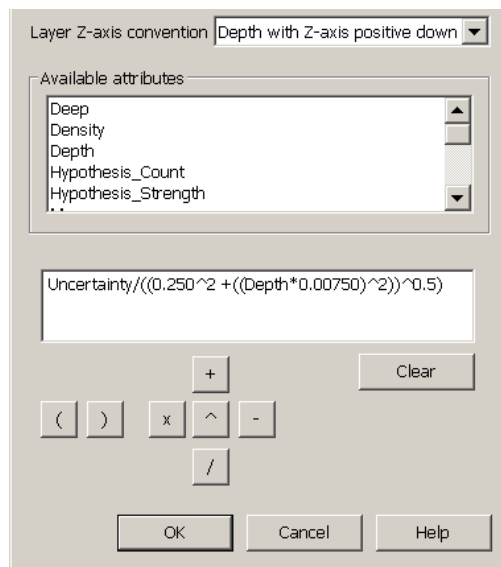

Figure 13.48 Window with uncertainty and TVU layer information.

Now the outcome obtained is as follows:

Min Range:	0.15
Max Range:	0.45

Table 13.7 Values obtained in the proportion of Figure 13.48.

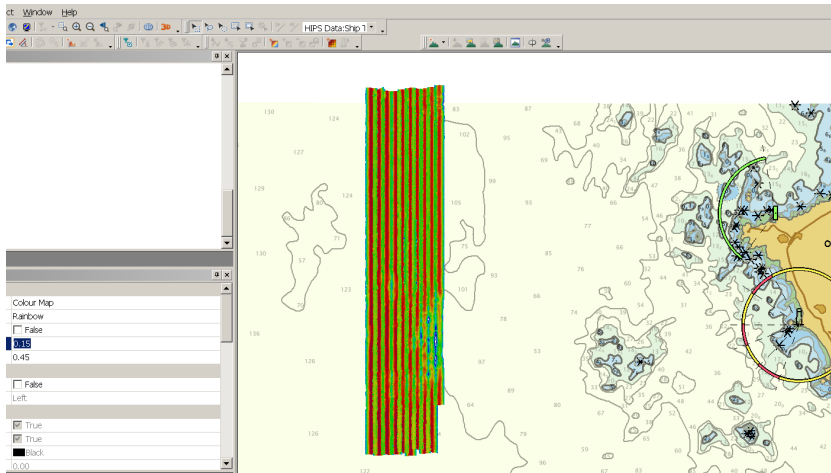

Figure 13.49 Values in red, green and blue are 0.2, 0.3 and 0.4 respectively, from the proportion between uncertainty and TVU layer of Special Order from the IHO.

With these values, this survey also complies with minimum standards of a Special Order.

Furthermore, you may use a filter, in Properties, to see high values. For the example used previously (Table 13.7 and Figure 13.49), you can put minimum value 0.35 and the maximum 0.45, as indicated in the next figure, in order to highlight high values.

Filter		Filter	True
Filter	<input checked="" type="checkbox"/> True	Min Val	0.35
Min Val	0.35	Max Val	0.45
Max Val	0.45		
Display			

Figure 13.50 Properties to highlight high values.

13.3 Generation of a file in CARIS to distinguish areas with few soundings

The layer *density* can be very useful to see the number of soundings per node, in according with the resolution selected. You select the layer *density* in the BASE surface generated and move the cursor of your mouse on the BASE surface to see the density of soundings per node.

It is possible to make a file to distinguish the areas with few soundings. The steps to make this file and detect where the soundings are scarce in a specific survey are the following:

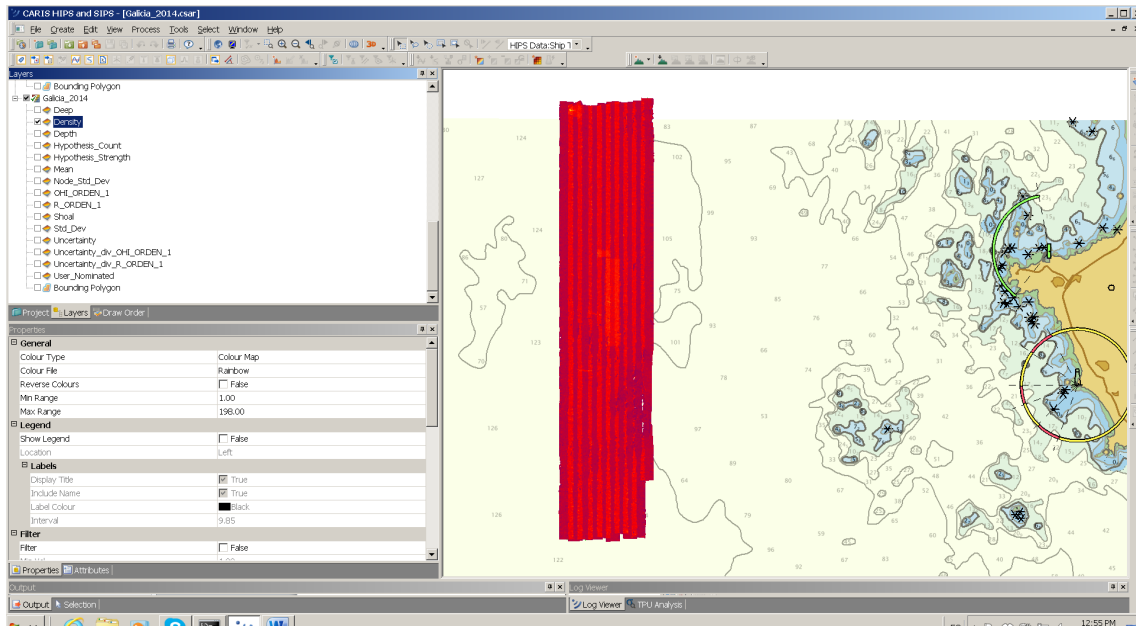

Figure 13.51 Illustration of the density of soundings per node in the BASE surface.

In Figure 13.51 (above), the interval of density of soundings ranges from 1 to 198, at a specific resolution.

The first step to make a file and distinguish the areas with few soundings is going to properties and select < colour file >, < new >.

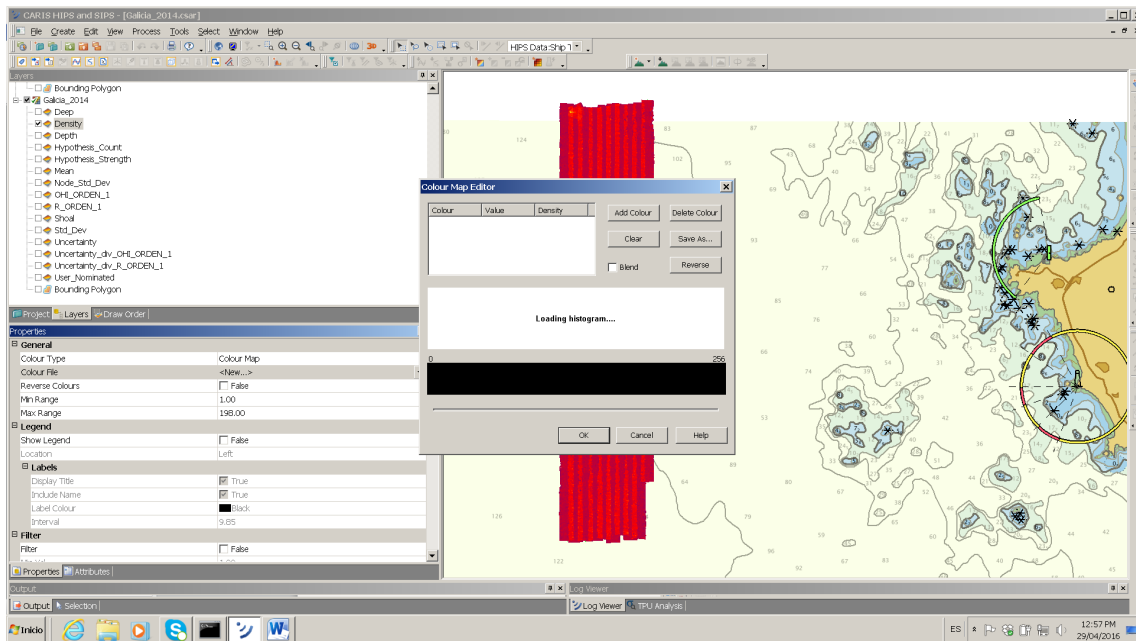

Figure 13.52 Make new file.

Click on < Add colour >.

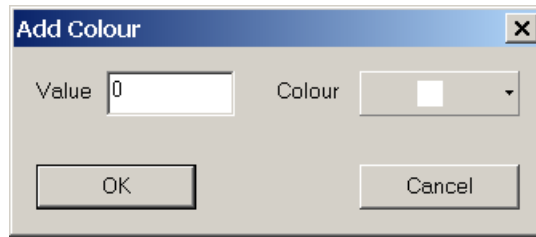

Figure 13.53 Select color.

In the window, add 1 in < Value > and select the colour that you want (for example yellow).

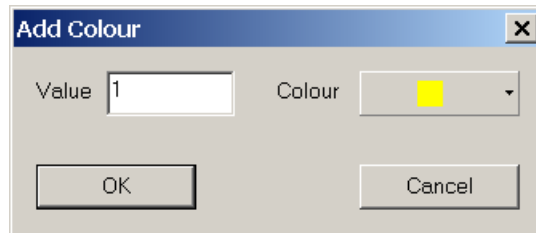

Figure 13.54 Add color value.

Click ok.

Then add another colour, adding the value “6” to see the cells where there are at least 6 soundings per node.

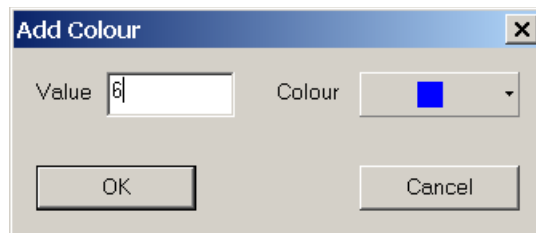

Figure 13.55 Add second color value.

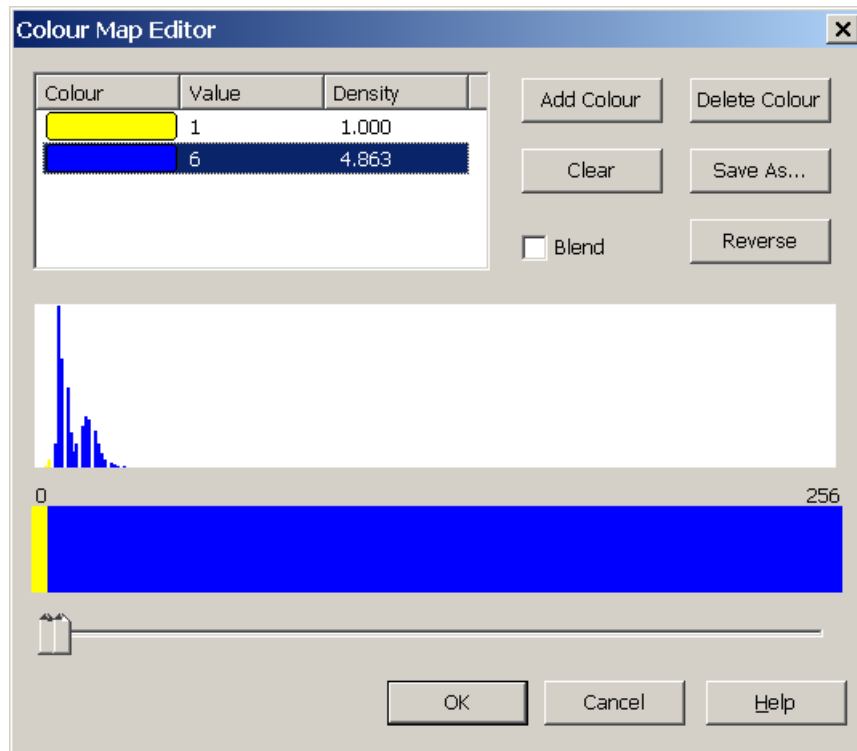

Figure 13.56 Color map editor.

Click ok, and save the file. The extension of these files is < cma > (Figure 13.57).

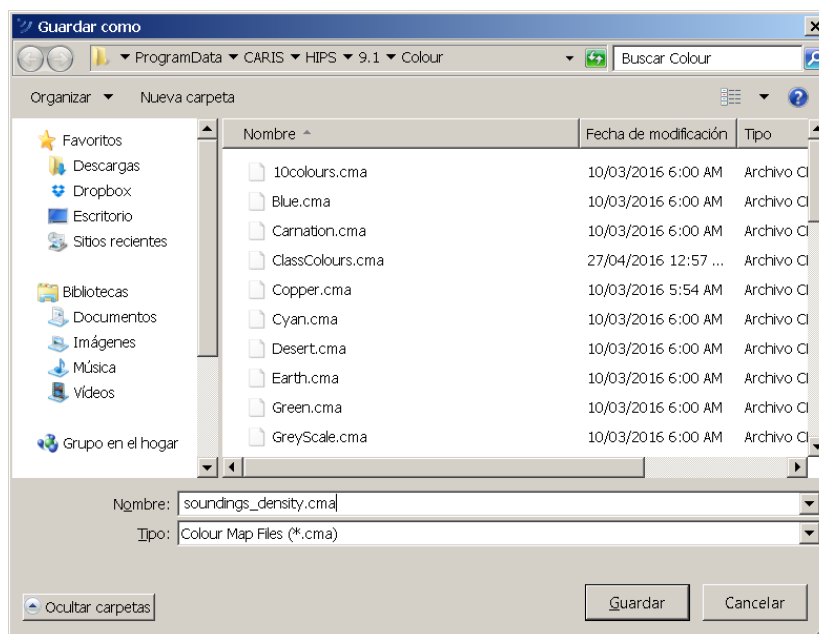

Figure 13.57 List color files.

Then, select the colour file in properties to distinguish the places where the soundings per node are below 6, at a specific resolution (Figure 13.58).

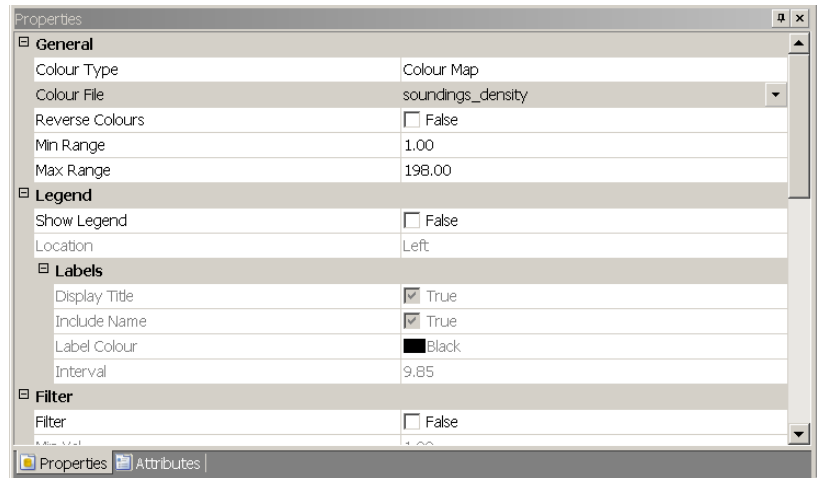

Figure 13.58 Select color file in properties.

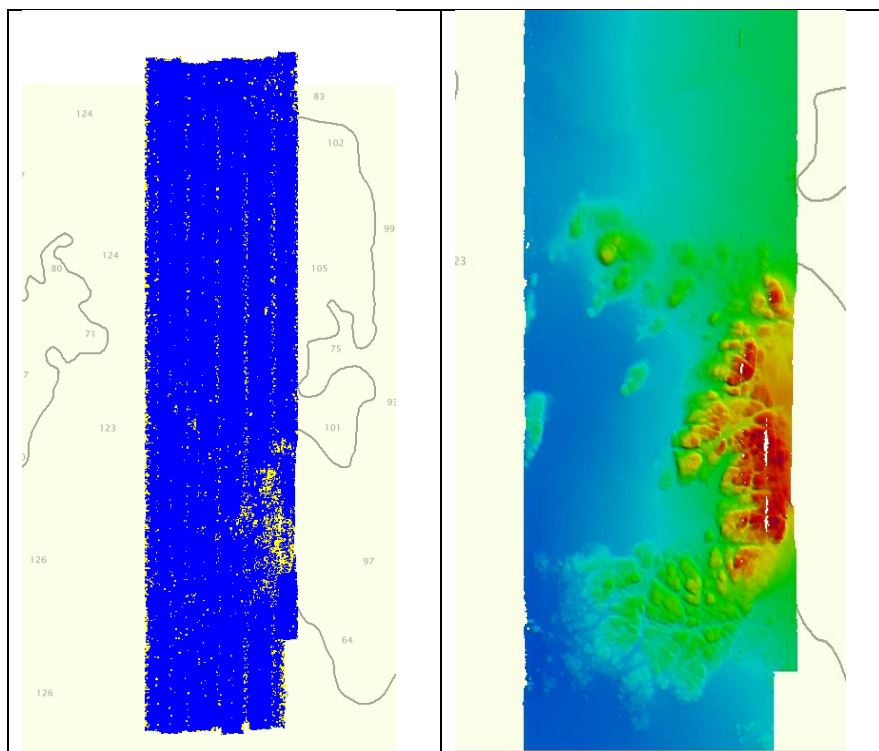

Figure 13.59 Survey colored for sounding density (left) and BASE layer (right).

On the left side of Figure 13.59, you can detect the places where the soundings are scarce in this survey (yellow areas indicate that there are less than 6 soundings per node). On the right side of the figure is the BASE surface. It is clear that the area with least soundings is the rocky area and the overlapping area between the survey lines.

The generation of this file can be very useful to see the areas where the number of soundings per node is scarce (for this example the file was made to see the number of soundings below 6) and where the hydrographer has to spend more time in the edition phase.

You can also make a file to detect the areas where the number of soundings is below 10. This file can be very useful for Special Order surveys.

Chapter 14.0 Nautical Chart Adequacy Procedure

Contributed by A. Klemm and J. Nyberg, National Oceanic and Atmospheric Administration, USA, S. Pe'eri and R. Wigley, Center for Coastal and Ocean Mapping, USA, Limor Gur-Arieh, Survey of Israel, Israel, Y. Kamaruddin, National Hydrographic Center of Malaysia, Malaysia, A. Kimeli, H. Kurita, I.B. Prasetyawan, J. Roperez, N. Samarakoon, and M. Vallee, Nippon Foundation/General Bathymetric Chart of the Oceans Scholars Program, USA, J-Y Roh, Korean Hydrographic and Oceanic Administration, Korea, J. Sydenham, United Kingdom Hydrographic, U.K.

The nautical chart is a tool used by mariners for safe navigation through the seas and guidance for anchoring. Due to limited resources and survey priorities, decades may pass until a new hydrographic survey can be conducted to update the survey measurements that are used to compile a given chart. Even then, the compilation time to transfer survey data into chart soundings and contours may take several years. As a result, shoreline and depth data in some charts are outdated and may have changed over the years due to natural events and/or coastal development. From a global perspective, the International Hydrographic Office (IHO) reviews in its C-55 publication (*Status of Hydrographic Surveying and Nautical Charting Worldwide*) the percent coverage of hydrographic surveying and nautical charting for a country with navigable waters under its jurisdiction. For any marine cartographer around the world, a similar set of questions is raised when evaluating a chart:

- When was last survey conducted over the charted area?
- Have there been any changes to the shoreline or the bathymetry since the last survey?
- Is it possible to prioritize areas on the chart that require more frequent updates?
- Can we evaluate chart adequacy and update it before we are able to conduct another survey in the area?

In recent years, different types of marine information became accessible to the public with cartographic value. This marine information includes: horizontal positioning of ships, satellite imagery, and shallow-water bathymetry collected in non-hydrographic surveys. The Nautical Chart Adequacy Evaluation (NCAE) procedure described below can provide transitory products for mariners until a survey that can meet IHO standards can be conducted (IHO, 2008). The procedure is based on hierarchy of evidence ranging from hydrographic and geodetic standard to best available resources that The NCAE procedure has been developed in ArcMap ESRI environment and utilizes different **publicly-available non-hydrographic data sources and products to support policy and cartographic decisions. Three key data sources used in the procedure are:**

- *Automatic Identification System (AIS)* - Messages that are broadcast over VHF maritime band at a certain frequency in order to avoid collision. One type of AIS message is a dynamic (position) message that contains key parameters, such as position, time, speed, and course information.

- *Satellite-Derived Bathymetry (SDB)* - Bathymetry estimation derived (reconnaissance approach) using a band-ratio calculation from satellite imagery. The imagery used in this study are multispectral imagery acquired by the Landsat satellites.
- *Surveys of opportunity* - Surveys that do not meet IHO S-44 order 1 (IHO, 2008). These surveys may have been conducted for coastal management or oil prospecting programs and are available for analysis. Typically, only depth measurements are available from these surveys as a point cloud.

The goal of the approach is to develop a standardized procedure that can be transferable to cartographers, hydrographers and potential chart producers from hydrographic offices and government agencies around the world. The focus of the procedure is on quality management based on the hydrographic characteristics of the chart (as opposed to uncertainty management, where risk is calculated based on potential consequences by different users and vessels in different marine settings). It is assumed that every S-57 attribute can be provided as an ArcMap feature with a table containing the required fields that are required for S-57. The two main attributes that will be used in the procedure here are MQUAL and SOUNDG.

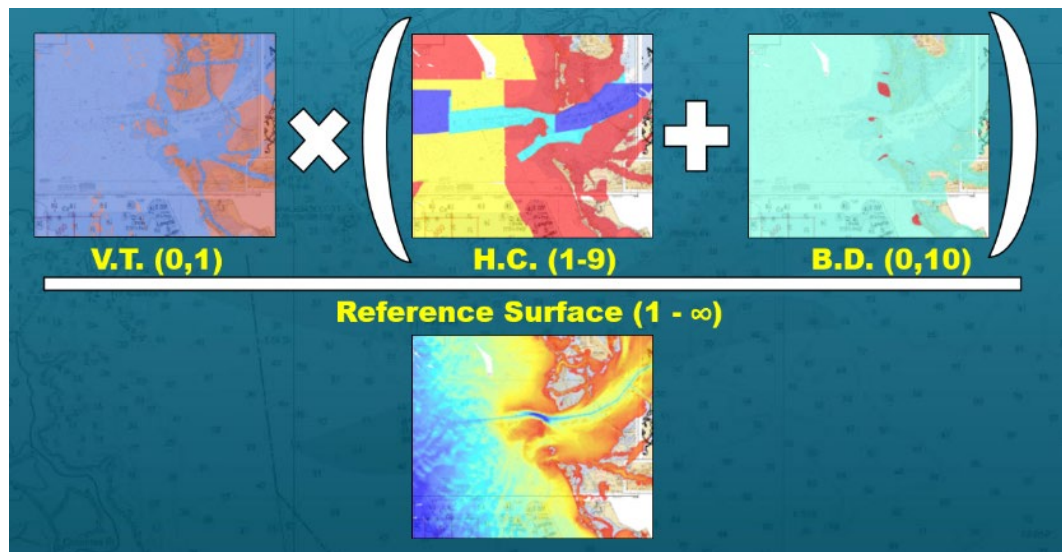

Figure 14.1 Schematic illustration of the four source layers used in NCAE algorithm.

Four layers are utilized for the chart adequacy procedure that include (Figure 14.1):

- *Bathymetric Difference (Section 14.4)* - A current reconnaissance bathymetric dataset is generated using recent surveys of opportunity and is supplemented using SDB in coastal and shallow-water areas. Although it is possible to use GIS tools to monitor and quantify changes between the charted and the reconnaissance depth curves, it was found that manual digitization of a polygon surrounding the areas of discrepancy provides a quicker and simpler approach to execute. Polygons that have identified areas with discrepancy were classified with a “10” value. The rest of the charted area that does not contain major bathymetric differences is classified with a “0” value.
- *Vessel traffic (Section 14.5)* – The goal of the chart adequacy procedure is to investigate if the information on the chart is suitable for navigation. Accordingly, the investigation should focus only the traffic routes. In this procedure are derived from AIS datasets that provide the vessel traffic density. The class values for

vessel traffic were Boolean conditions that “true” answers (i.e., areas that are considered a navigational route) were assigned a class value of “1” and a “false” answers (i.e., all other areas) were assigned a value of “0”. Thus, a multiplication with the vessel traffic layer will retain only the navigational route areas.

- *Hydrographic Characteristics (Section 14.6)* –It is possible to classify the charted areas based on the survey dates and survey technology provided by the source diagram or the metadata associated with the CATZOC. A decision-tree (Table 14.1) was developed using three survey qualifiers that can be received from RNC or ENC. The values attributed to the classes in the hydrographic characteristics layer range from “0” to “9”, where higher values indicate that the charted area is less adequate and requires more attention. The three qualifiers include bottom coverage, positioning technology, and survey technology.

Table 14.1 Ranking of the Hydrographic Characteristics classes based on the three survey qualifiers (bottom coverage, survey date and survey technology).

Bottom coverage	Survey Date	Technology	Rank
No bottom coverage	--	--	9
Partial bottom coverage	Pre-1975	Leadline	9
Partial bottom coverage	Pre-1975	SBES	8
Partial bottom coverage	Pre-1990	SBES	8
Partial bottom coverage	Pre-1990	MBES	7
Partial bottom coverage	Pre-2000	SBES	7
Partial bottom coverage	Pre-2000	MBES/ALB	6
Partial bottom coverage	Post-2000	SBES	6
Partial bottom coverage	Post-2000	MBES/ALB	5
Full bottom coverage	Pre-1975	Leadline	5
Full bottom coverage	Pre-1975	SBES	4
Full bottom coverage	Pre-1990	SBES	4
Full bottom coverage	Pre-1990	MBES	3
Full bottom coverage	Pre-2000	SBES	3
Full bottom coverage	Pre-2000	MBES/ALB	2
Full bottom coverage	Post-2000	SBES	2
Full bottom coverage	Post-2000	MBES/ALB	1

- *Reference Surface (Section 14.3)* – In is important to evaluate the chart quality in context of depth. This issue is also noted in the IHO survey standards S-44 (IHO, 2008). The chart quality properties in the chart adequacy procedure are normalized using the charted surface to provide more weight for shallower areas. The reference depth is generated using the best available survey data. In this procedure, the survey data from the chart soundings is gridded using inverse distance weights (IDW) interpolation. In order to avoid boundary conditions caused by the interpolation or division of “0 meter” depth, depths shallower than 1 m (to the charted vertical datum) were excluded from the evaluation.

Note: There are many ways to access the information necessary to create and process the Hydrographic Characteristics Layer. This information may come from survey outlines, the source diagram on paper charts, hydrographic survey descriptive reports, or the CATZOC attribute in MQUAL for large scale charts. Not all hydrographic offices have completely encoded the MQUAL feature with CATZOC, and therefore supplementary information may be necessary to create the Hydrographic Characteristics layer. In some cases, the source of technology (TECSOU) has multiple codes (Table 2, Section 14.6). A conservative approach is used in this procedure, where the lower performing technology is chosen for the assessment.

14.1 Setting up the workspace (ArcMap)

Open ArcMap (either by a double-click on the ArcMap icon or selection from the windows Start/All Programs).



Note: If this is your first time using ArcMap, You will get this window the following window. Press **OK**.

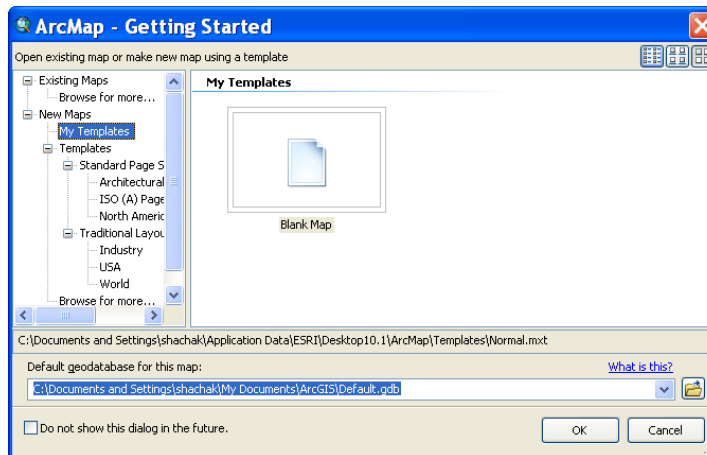

Select **Extensions...** Under the **Customize** Tab.

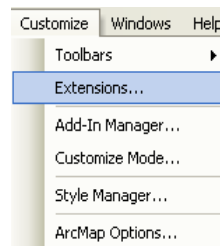

In the **Extensions** window, mark **3D Analyst** and **Spatial Analyst**. Press **Close**.

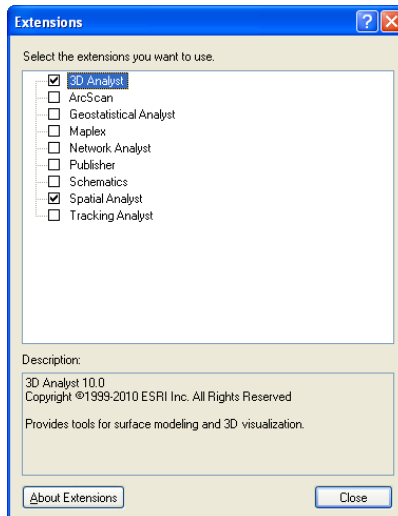

Note: If 3D Analyst is not available in your ArcMap license, skip the next steps.

Select **Toolbars...** under the **Customize** tab and select **3D Analyst**.

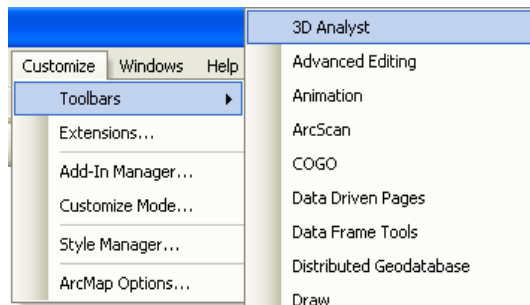

An undocked **3D Analyst** toolbar will appear. Dock it next to the upper toolbars.



Select **Toolbars...** under the **Customize** tab and select **Editor**.

An undocked **Editor** toolbar will appear. Dock it next to the upper toolbars.



Select **Toolbars...** under the **Customize** tab and select **Spatial Analyst**.

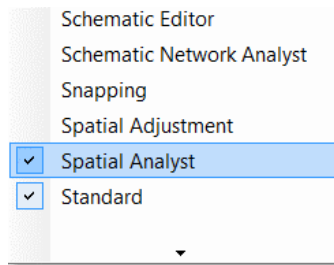

An undocked *Spatial Analyst* toolbar will appear. Dock it next to the upper toolbars.

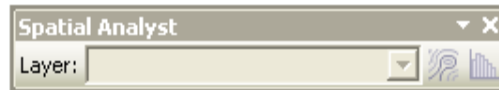

Activate the **Toolbox** by clicking on the icon in the upper toolbar.

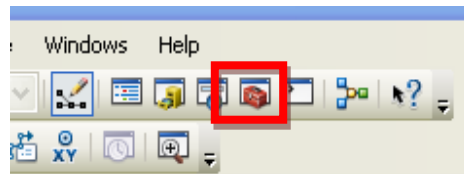

In the main menu, click on **File/Map Document Properties....** Check the box for **Store relative pathnames** to data sources. Click **OK**.

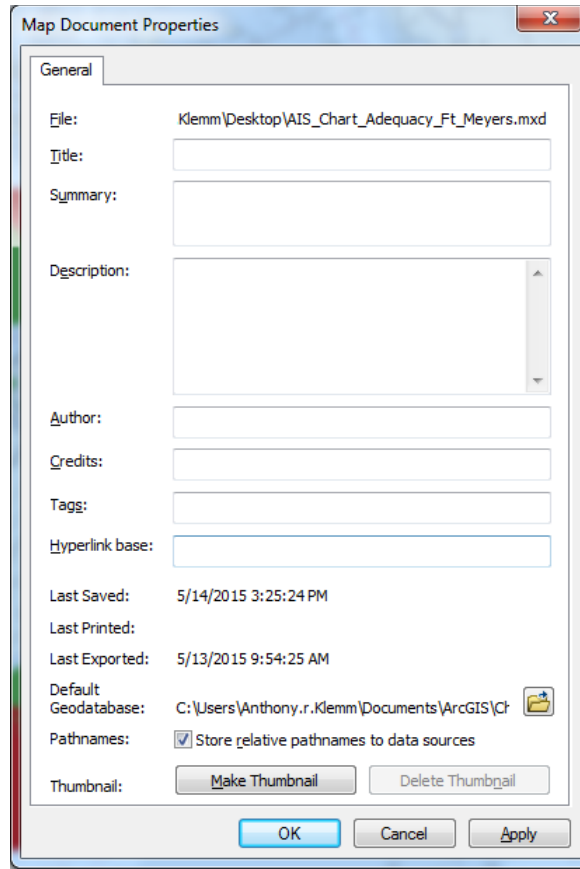

In order to validate that ArcMap is properly executing the command, click on **Geoprocessing/Geoprocessing Options...** in the main menu,

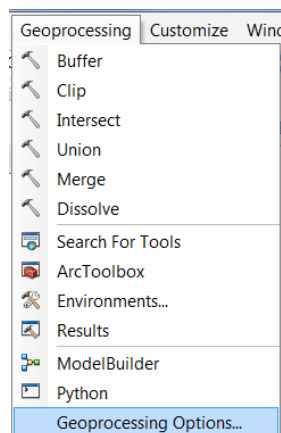

In **Geoprocessing Options** window, uncheck the **Enable** box under **Background processing** and press **OK**.

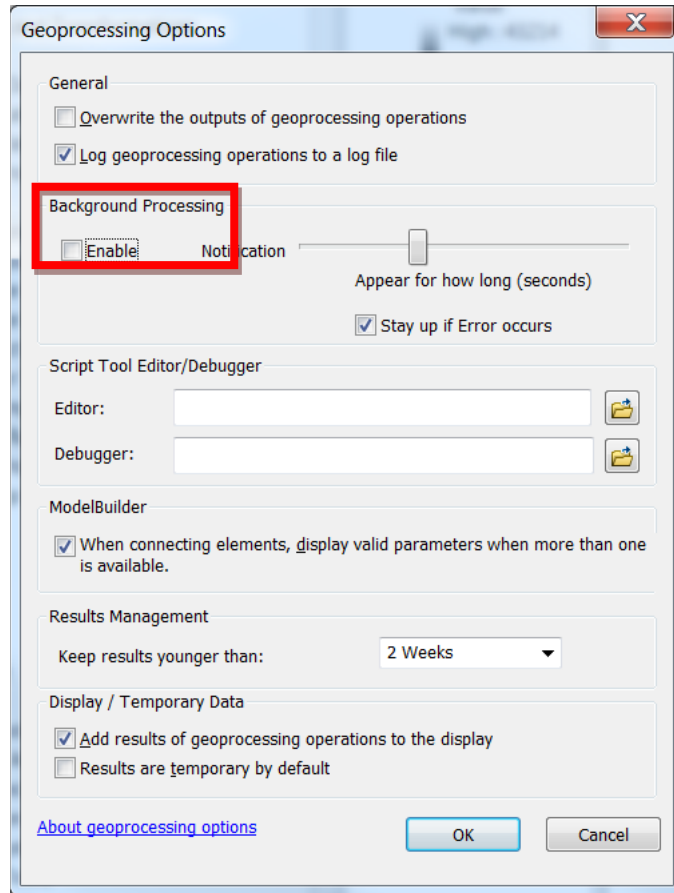

Activate the **Catalog** by clicking on the icon in the upper toolbar.

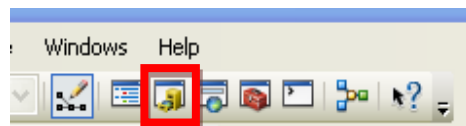

Navigate in the **Catalog** window, and create a **New Folder Connection**. Click on the **New Folder Connection** button in the Catalog toolbar and select the folder in the directory where your data is located. (e.g. C:\working).

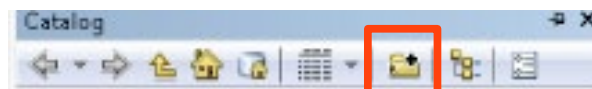

Navigate in the **Catalog** window into the desired directory, right-click and select **New/File Geodatabase**.

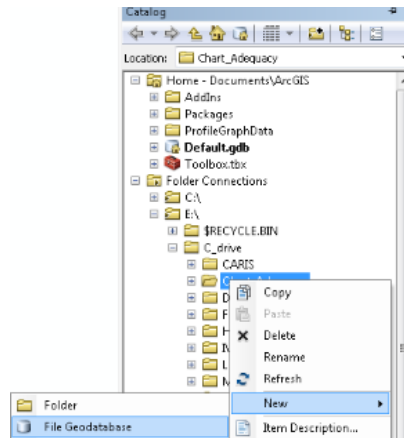

Right-click on the new Geodatabase and select **Rename**.

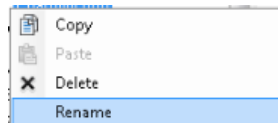

Change the name of the Geodatabase to the chart's name/number and press **Enter**.

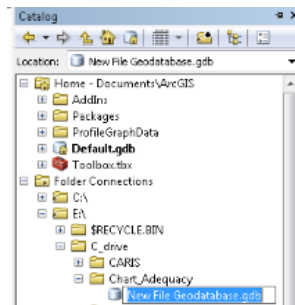

Right-click on the new Geodatabase again and select **Make Default Geodatabase**.

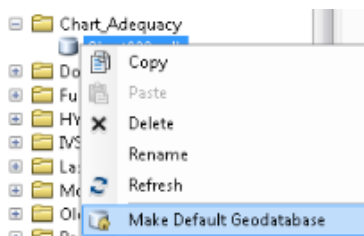

The new Geodatabase should be bold (recognized by ArcMap as the default geodatabase).

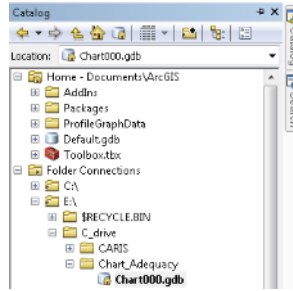

Save your project in the Site project directory by selecting *File/ Save As...* .

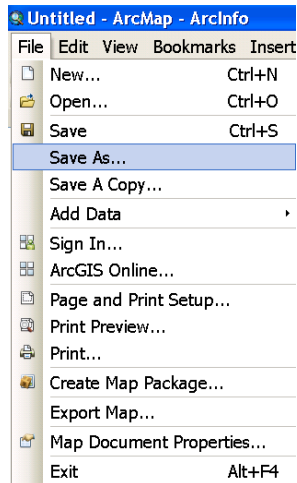

Make sure to save the MXD using the naming convention <chart name>_<date>.

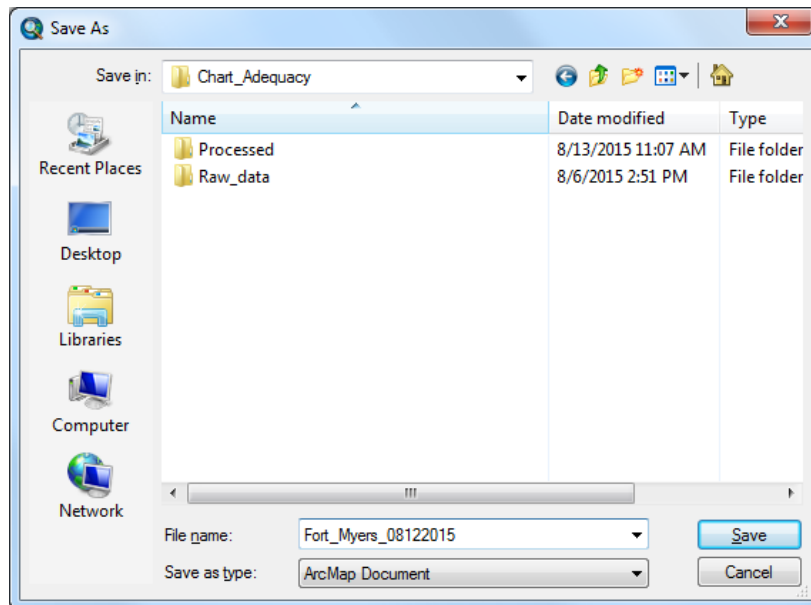

14.2 Loading the dataset into the project

14.2.1 Raster Navigation Charts (RNC)

In the main menu, load the RNC data to ArcMap by right-clicking on the desired directory and select *Add Data...*



Navigate to the directory containing the raster charts, select your chart and press *OK*.

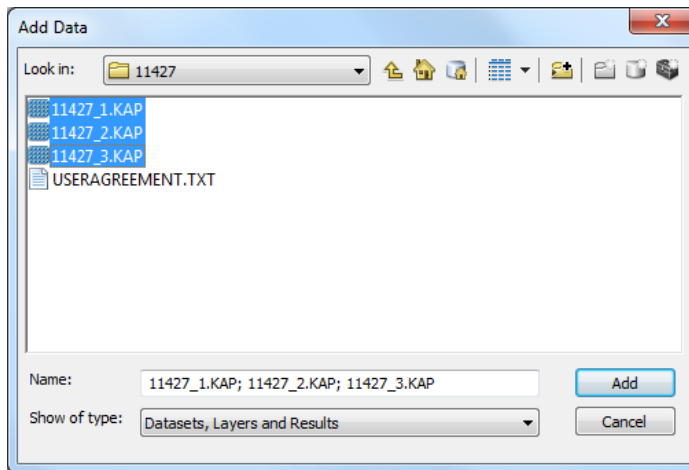

Note: The format of the chart between hydrographic office (e.g., GeoTiff, KAP, etc.)

The software should recognize the chart datum. ***IF NOT***, right-click on **Layers** in the **Table of Contents** window and select *Properties...*

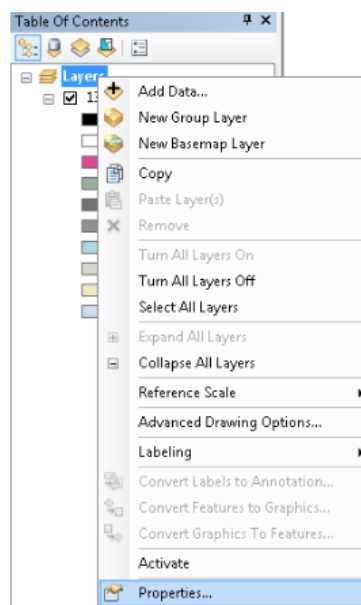

In the **Data Frame Properties**, select the proper datum (coordinate system) under the **Coordinate System** tab and press **OK**.

Note: In this example, the system is: Projected Coordinate Systems/UTM/ WGS 1984/Northern Hemisphere/WGS1984 UTM Zone 17N.

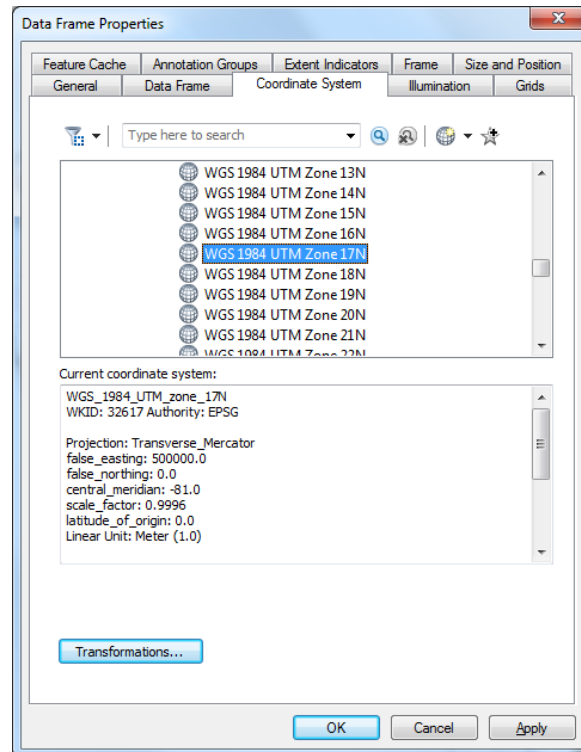

14.2.2 S-57 files from the Electronic Navigation Charts (ENC)

Load the ENC layer data to ArcMap by selecting **Add Data...**



Navigate to the directory containing the ENC files, select **MQUAL** and **SOUNDG** files and press **Add**.

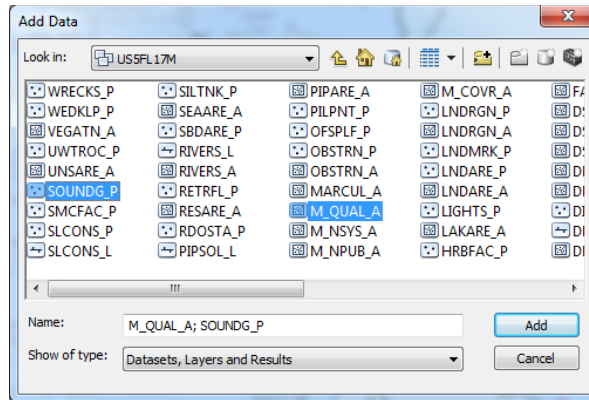

Select **Data Management Tool/ Projection and Transformations/Project** to convert the shapefiles from geographic coordinates into a UTM projection (the zone will differ with location).

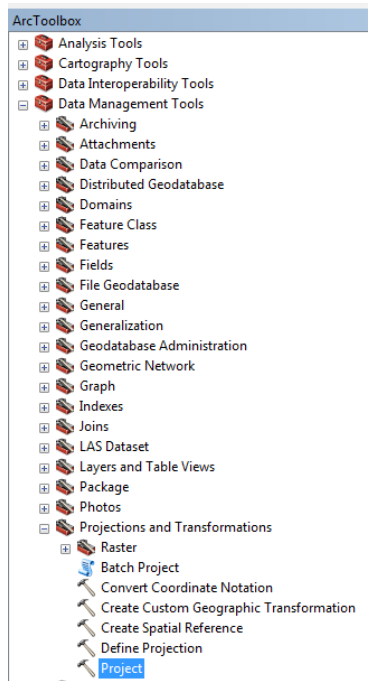

Type "SOUNDG_UTM" as the Output Feature Class and select the Output Coordinate Systems as: WGS_1984_UTM_zone_17N.

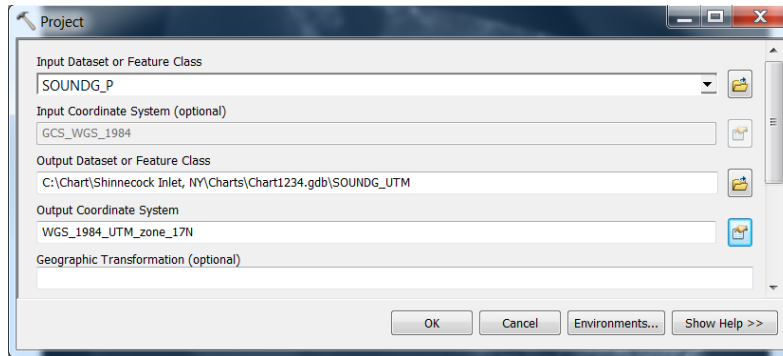

Similarly, project the M_QUAL feature class to UTM (WGS-84 ellipsoid).

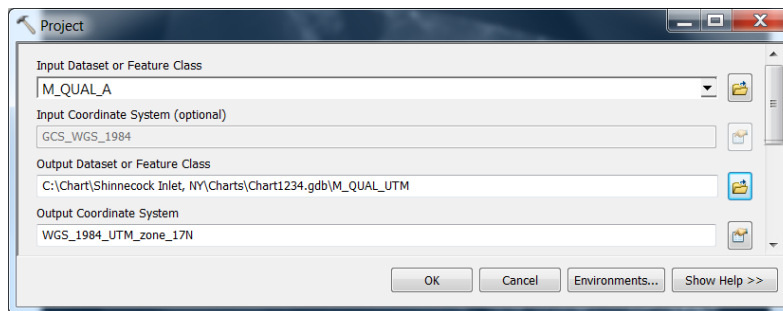

Remove the original **SOUNDG_P** and the M_QUAL_A layers opened directly from the ENC (not the new feature class you just created) from your table of contents by right clicking on the layer, and clicking **Remove**.

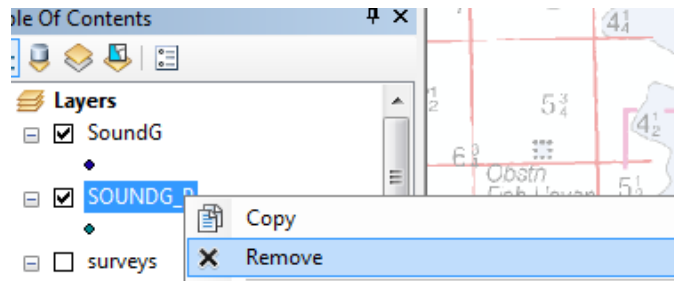

14.2.3 Satellite layers (Landsat)

Open a Web Browser and go to <http://earthexplorer.usgs.gov/> . Login into your account (the Login button is upper right corner of the window).

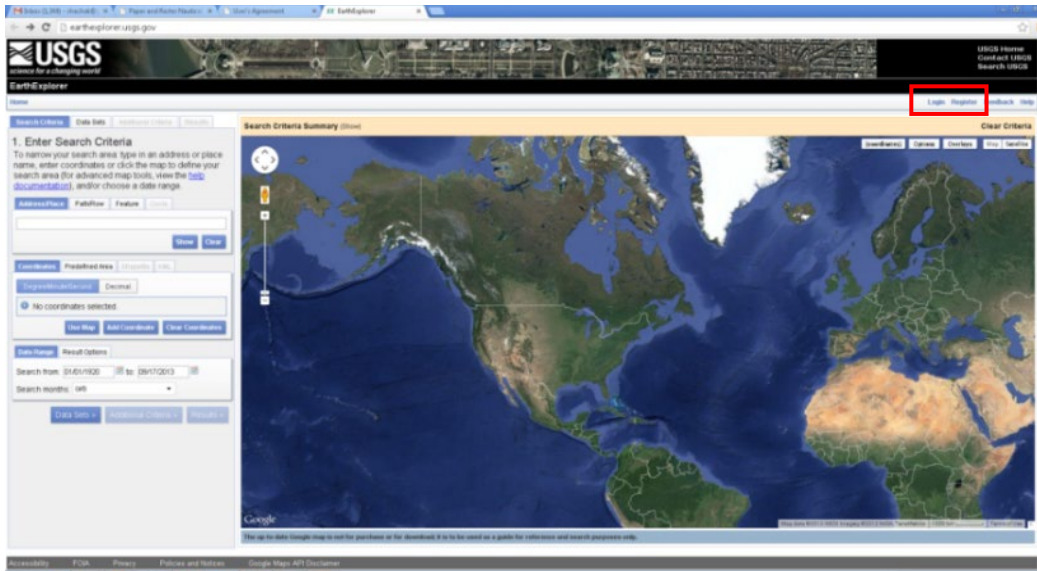

Note: The service is free, but the website requires user to login. Users that are accessing this site for first time need to register (the **Register** button is upper right corner of the window).

Zoom into the desired region. Create a square around the desired region by clicking on the corners of the area. The polygon vertex coordinates will appear in the Search Criteria tab.

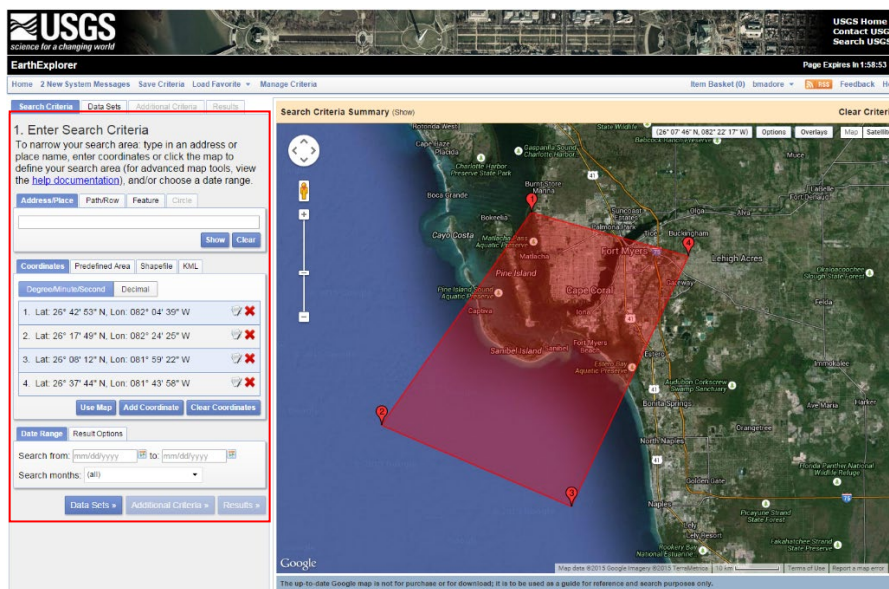

Alternatively, type in a location you are interested in and the country in the **Address/Place** located under the **Search Criteria** tab and click on **Show**. Select the site of interest from the list of possible sites with similar names and the location will be shown on the map.

1. Enter Search Criteria

To narrow your search area: type in an address or place name, enter coordinates or click the map to define your search area (for advanced map tools, view the [help documentation](#)), and/or choose a date range.

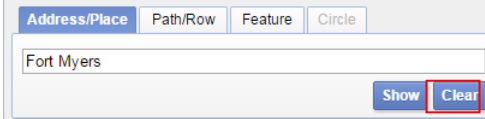

On the top left side of the screen, click on the *Data Sets* tab.

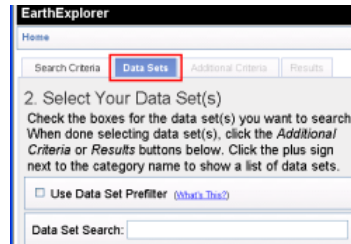

Expand the **Landsat Archive** and select **L8 OLI/TIRS** for Landsat8 imagery and click OK then click Results.

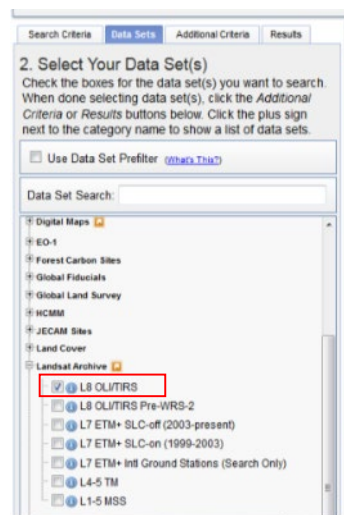

Select the *Results* tab.

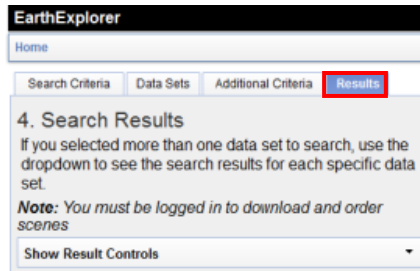

Scroll down and look at the quick view results. Select the download icon of the desired data set.

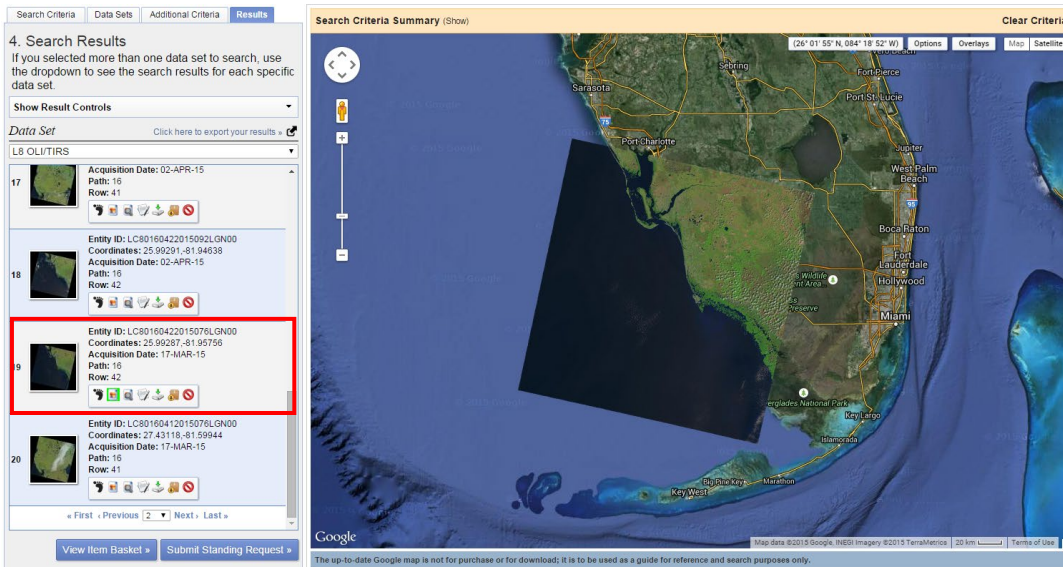

Before selecting the image, it is possible to preview the image by clicking on *Show Browse Overlay*.

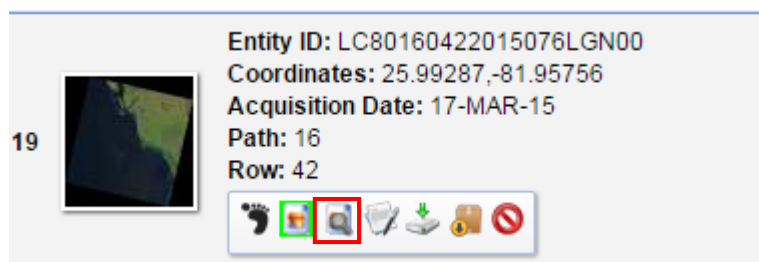

Select *Download* to display the area you are interested to process.

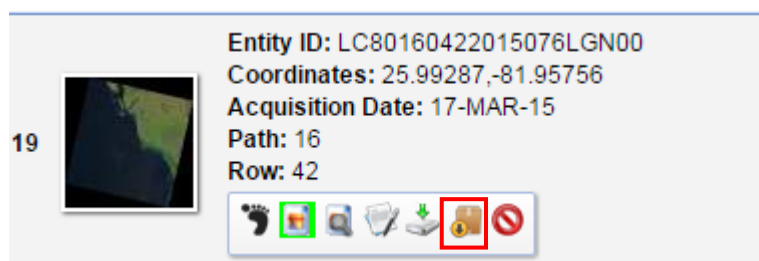

Select **Level 1 GeoTiff Data Product** and press **Download** in the **Download Options** window.

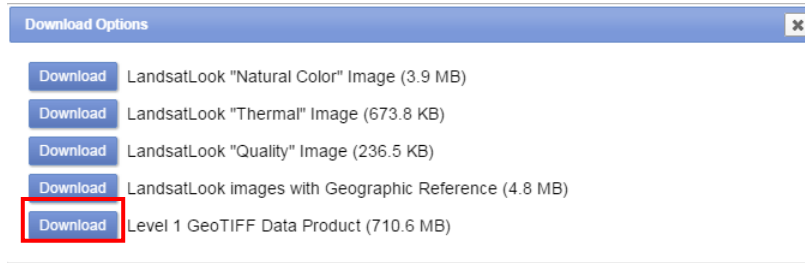

Extract your *.zip file into your local directory.

Note: The bands of Landsat imagery are typically download as separate imagery files in *.Tif format and not as a single multi-band image (e.g., WV-2).

Note: In case that disk space is an issue, delete the *.zip file and bands B7 to B11.

Load the satellite data to ArcMap by selecting **Add Data...** in the main menu.



Navigate to your directory and select the satellite images in the **Add Data** window and select **Add**. The Blue, Green and Infrared bands in Landsat 8 are numbers as: *_B2.tif, *_B3.tif, and *_B6.tif, respectively.

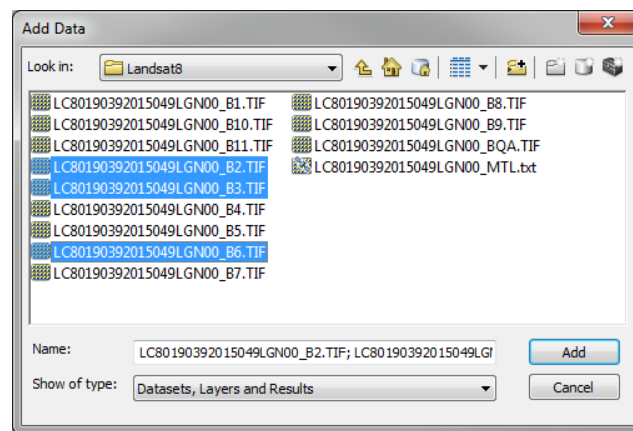

Note: If your imagery is not on your computer, you will need to use the **Connect to Directory** in order to link your project to your computer.



In case you are asked to create pyramids, press **Yes** for each image you open.

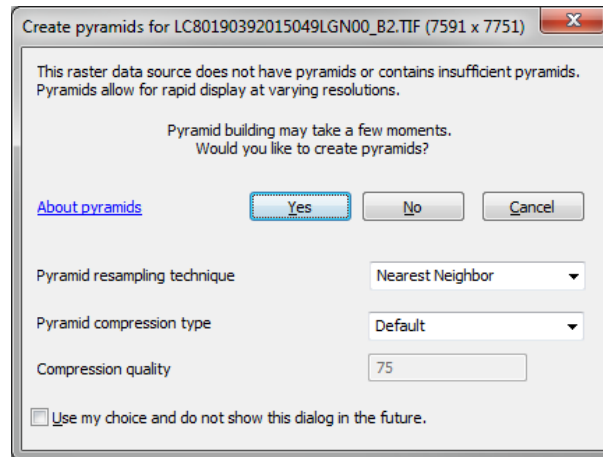

The satellite imagery will be loaded with black background (typically, background pixel value is 0).

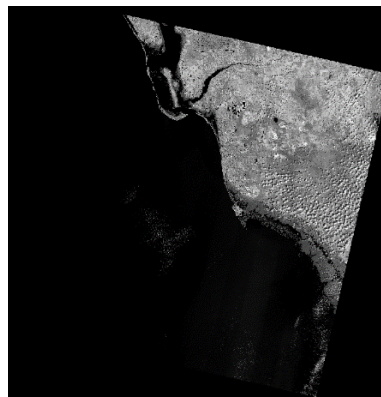

Right click on the image layer and select the **Properties...** button.

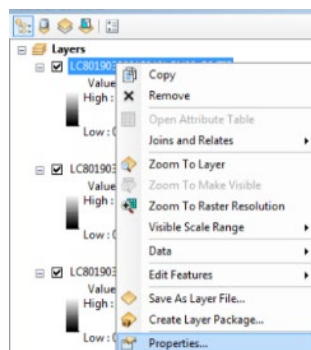

In the **Symbology** tab, check the **Display Background Value** box (in this case black is when the value is 0).

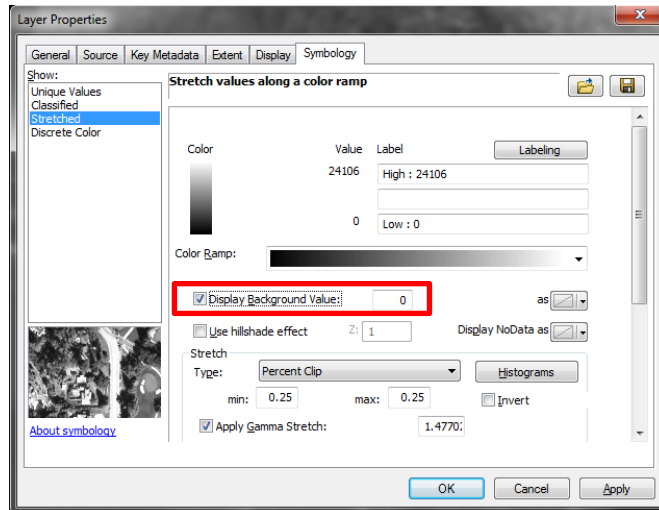

Press the *Apply* button and then the *OK* button in the Layer Properties window. Now the layer is without the black background. Repeat steps to remove background for the other layers.

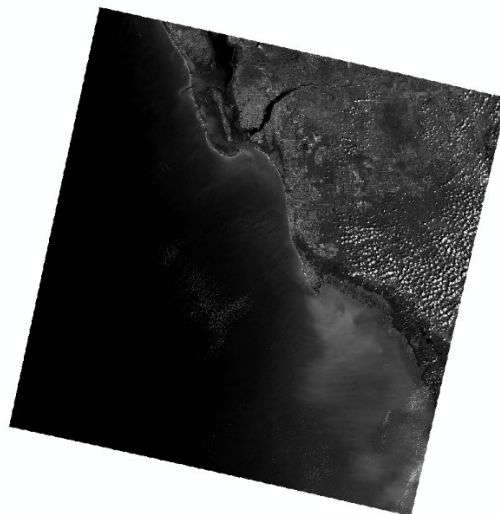

14.2.4 Automatic Identification System (AIS)

Load the AIS data to ArcMap by selecting *Add Data...*



Navigate to your directory and select the AIS point dataset (in this example: AIS_points_2011_ft_myers) in the **Add Data** window and select *Add*. The AIS broadcast points in the charted area will appear in the project.

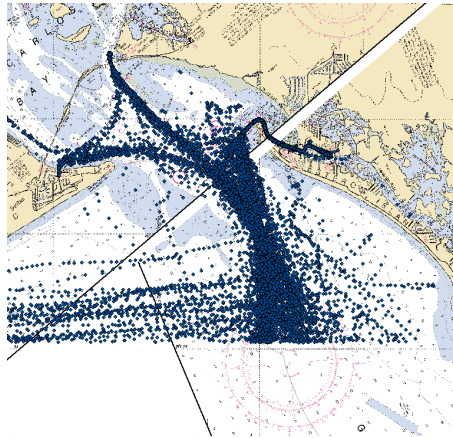

Select **Data Management Tool/ Projection and Transformations/Project** to convert the shapefiles from geographic coordinates into a UTM projection (the zone will differ with location).

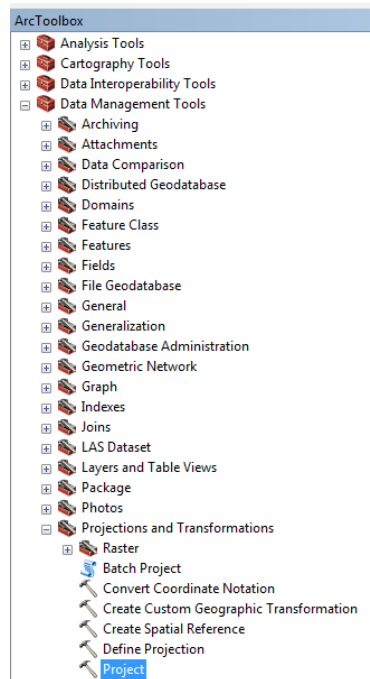

Type “AIS_points_UTM” as the Output Feature Class and select the Output Coordinate Systems as: WGS_1984_UTM_zone_17N.

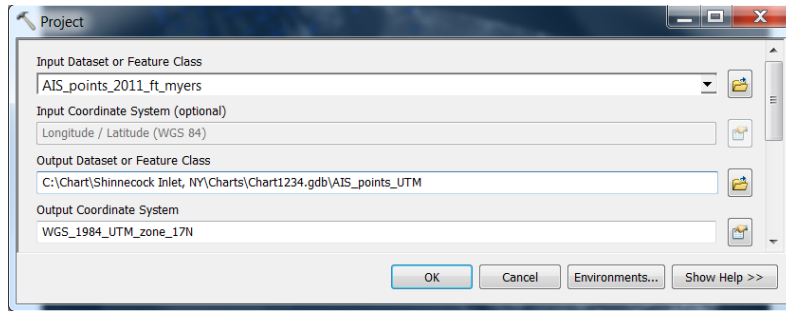

Save the project by selecting **File/Save** in the main menu.

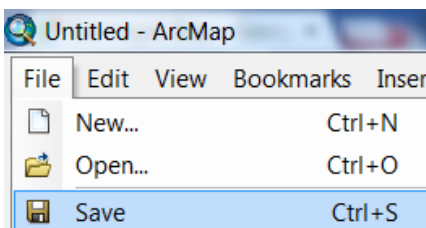

14.3 Reference surface

Note: Ideally, a complete dataset of survey soundings is available. However, there are many cases that only the chart sounding (as S-57 SOUNDG) are accessible. A point feature from either case can be used with the following steps.

Select *Interpolation\Inverse Distance Weighted (IDW)* from the *Spatial Analyst* toolbar.

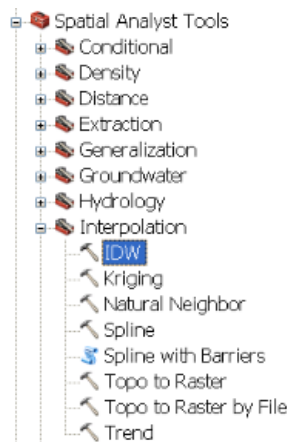

Select the survey soundings point feature and the input file, and fill in the following parameters: **depth** as **Z value field** with a **Fixed** search radius of **500 m** and an output cell size of **30 m**. Press **OK**.

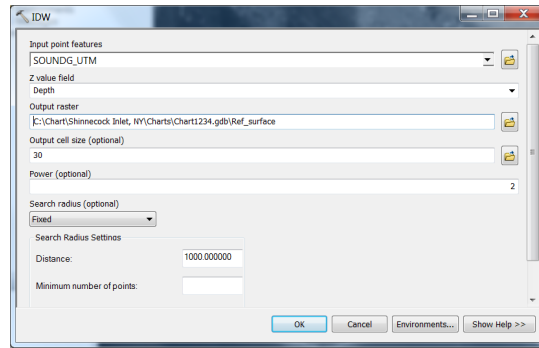

Note: The selection of 30 m grid is based on the satellite imagery ground resolution. Other grid resolution may be more adequate for different survey dataset (SDB or surveys of opportunity).

Turn off the point feature and visually evaluate the surface

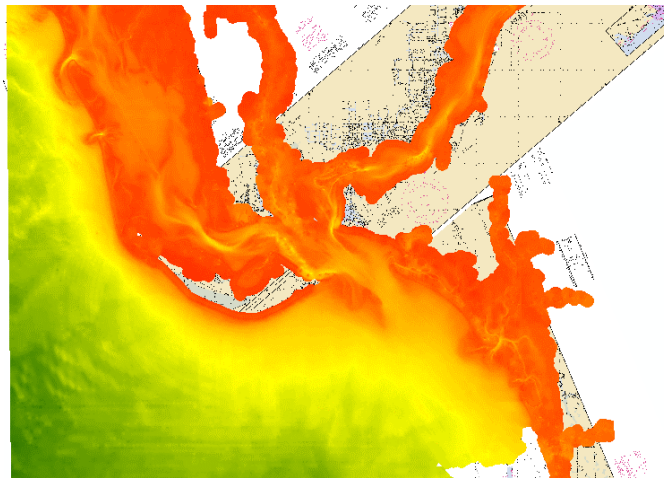

Remove the land from the blue and green imagery, by selecting **Spatial Analyst Tools/Conditional/Set Null** in the **Toolbox** window.

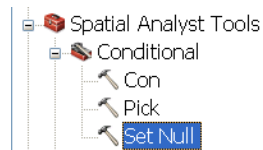

Fill the **Set Null** window as follows for removing the shoreline to 1 m depth from the reference surface and press **OK**.

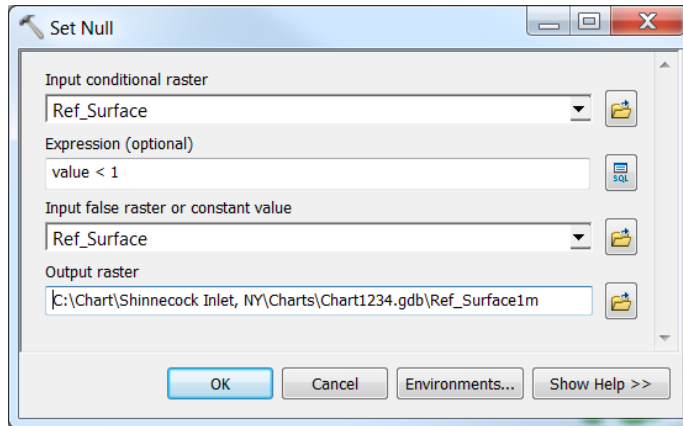

Save the project by selecting **File/Save** in the main menu.

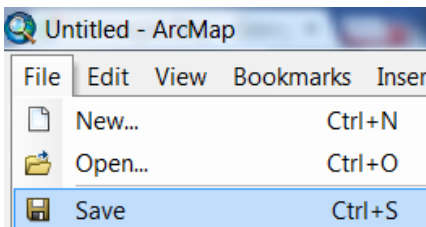

14.4 Bathymetric Difference layer

14.4.1 Satellite Derived Bathymetry (SDB) – Land/water separation

Note: There are several ways to calculate a threshold value for land/water separation. Two common options are: 1) **Profile**, and 2) **Identify**. A recommended approach is using the profile option, however this approach requires **3D Analyst** (not all users have this option under their current ArcMap license).

Option 1: Profile (using 3D Analyst)

Select **Extensions...** Under the **Customize** Tab.

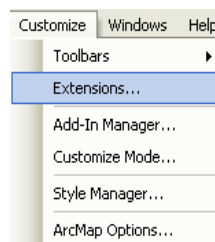

In the **Extensions** window, mark **3D Analyst**. Press **Close**.

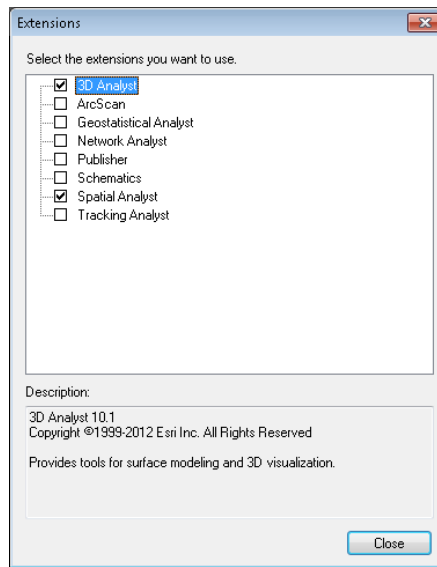

Activate the **3D Analyst** tool bar under the **Customize/Toolbars**.

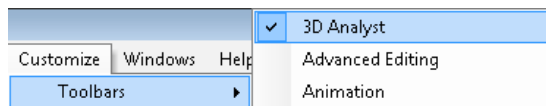

Select the infrared band (*_B6.tif in Landsat 8).



Press the **Interpolate Line** icon in the **3D Analyst** toolbar.



Make sure that the infrared band is visible in the project. Using the left button, draw a line that crosses from land (bright areas) into the water (dark areas). Finalize the line by double-clicking the left button.

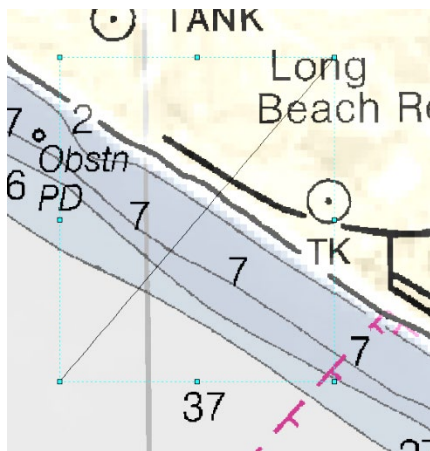

After drawing the line the **Profile Graph** icon in the **3D Analyst** toolbar will be active. Press the **Profile Graph** icon.



The result will be a plot that can be used to extract the land/water threshold. The smooth section with low values represents water, whereas the fluctuation high value areas represent land. In this case, the threshold value is around 5500 (Landsat 8 image).

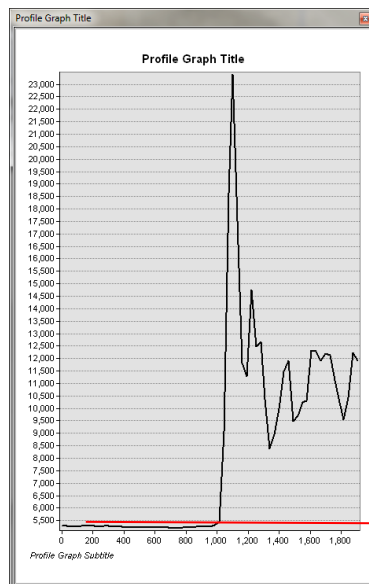

Option 2: Identify

Activate only the infrared band (*_B6.tif in Landsat 8).

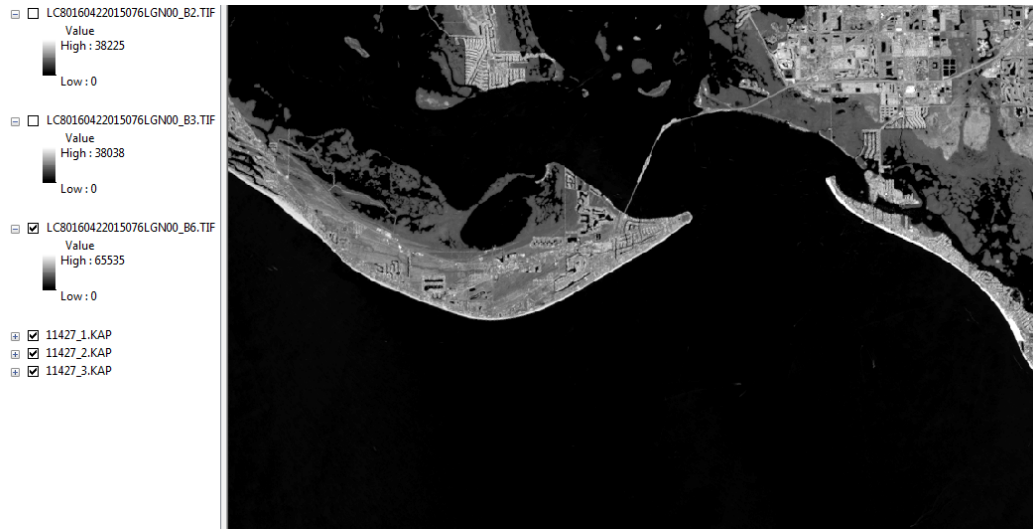

Select the *Identify* icon.



Click on several locations over the water and write down the values. Then, click on several locations over the land and write down the values. The threshold value should be between the water values and the land values (note: make sure you write down the **Pixel Value**).

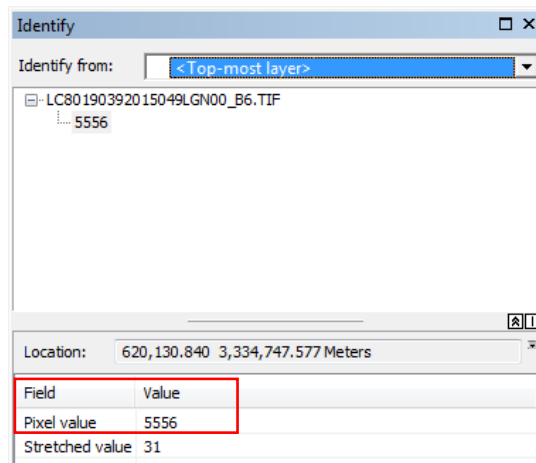

Note: Once you have identified the threshold value using the one of the two options, you can separate the blue and green layers as follows:

Convert the infrared band into float format, by selecting **Spatial Analyst Tools / Math / Float** from the toolbox.

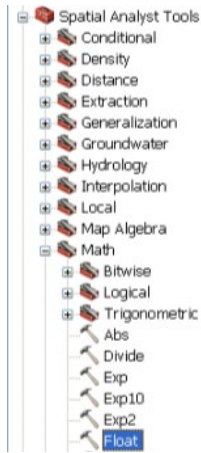

In the **Float** window, select the infrared band *_B6.tif in Landsat 8) and type in an output raster. Press **OK**.

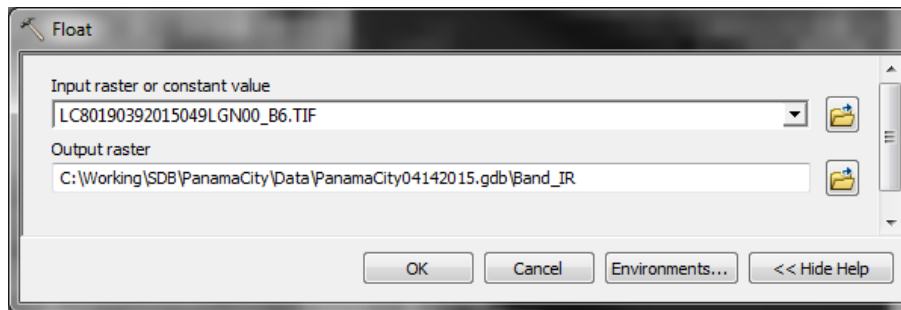

Repeat this step also for the blue *_B2.tif in Landsat 8) and the green *_B3.tif in Landsat 8) bands.

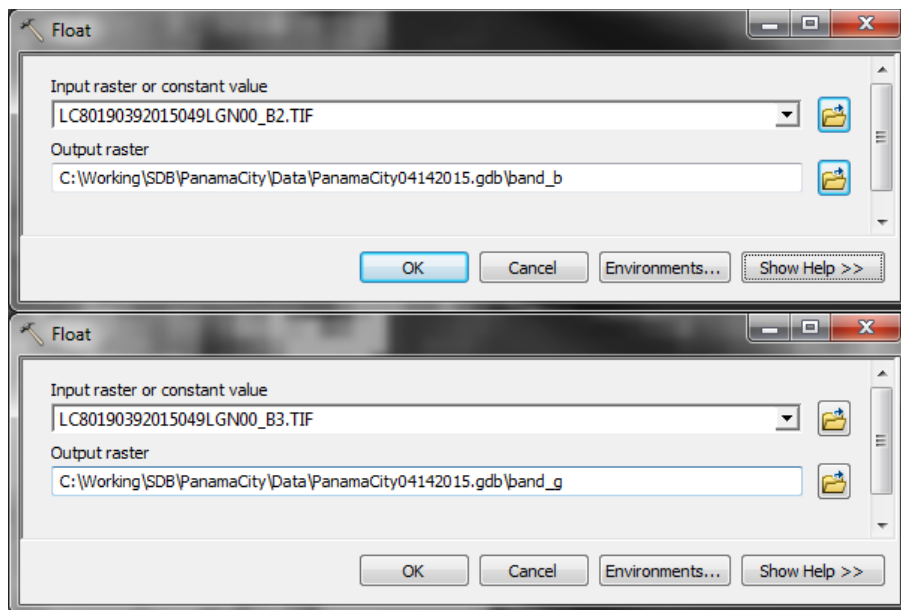

Next, apply a low pass filter (LPF) by selecting **Spatial Analyst Tools / Neighborhood / Filter**

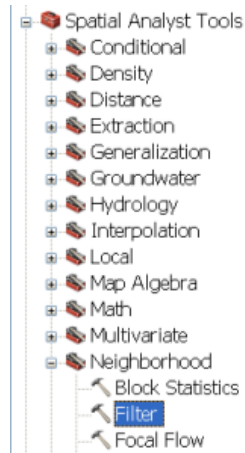

In the **Filter** window, select the infrared band in float format. Also, make sure that the **Filter type (optional)** is **LOW**. Press **OK**.

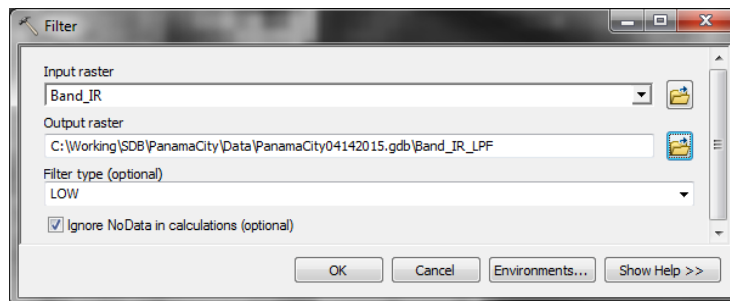

Repeat this step also for the blue and green float files.

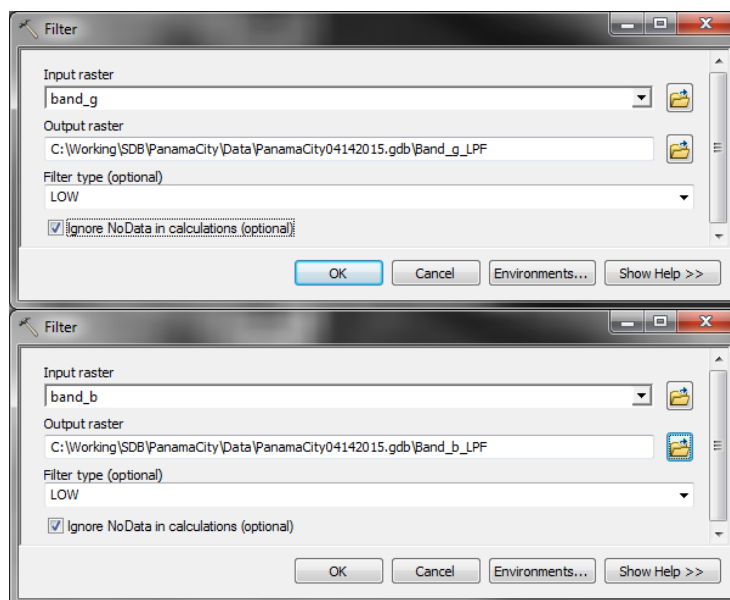

Remove the land from the blue and green imagery, by selecting **Spatial analyst Tools/Conditional/Set Null** in the **Toolbox** window.

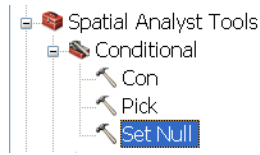

Fill the **Set Null** window as follows for the blue band and press **OK**. Make sure that the threshold value in the expression is the value calculated from the IR band.

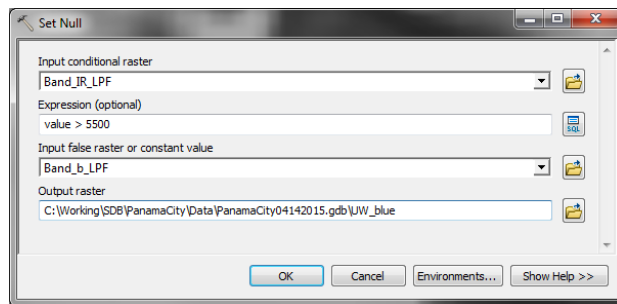

Repeat this step also for the green band.

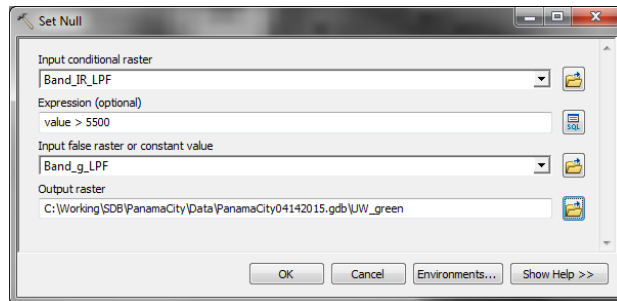

The new green and blue layer should contain areas only below the water.

Note: Make sure that the **Display background value** is set to 0 in the layer **Properties**.

14.4.2 SDB – Applying the bathymetry algorithm

Select **Spatial analyst Tools/Map Algebra/Raster Calculator** in the **Toolbox** window.

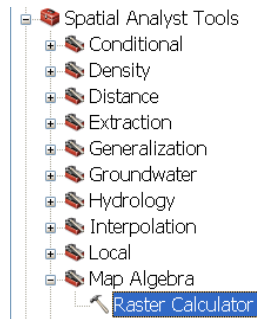

In the Raster Calculator window, write the following command: $\text{Ln} ("UW_blue") / \text{Ln} ("UW_green")$. Name the **Output Raster:** *Bath_alg*.

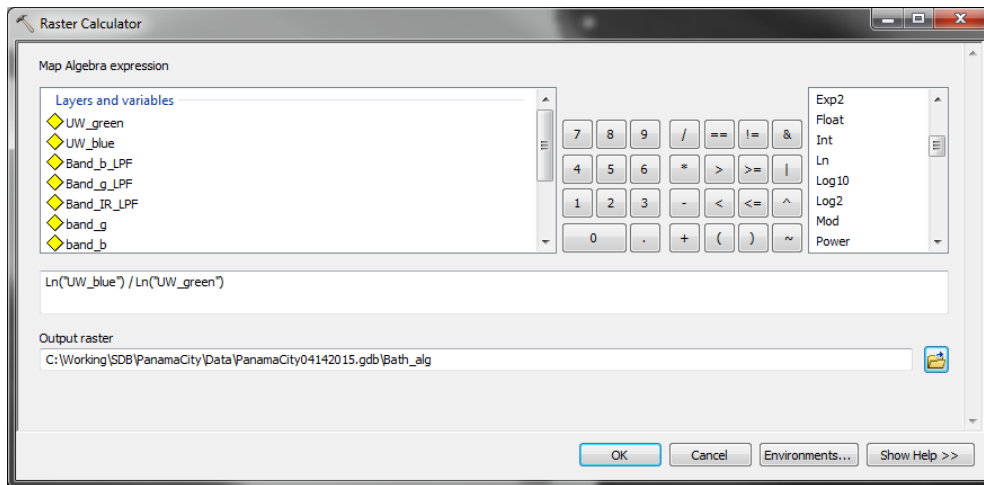

For visual inspection, select the layer *properties* of the “Bath_alg” layer from the **Table of Contents**. In the **Layer Properties** window under the **Symbology** tab, set the color ramp **Stretch: Standard Deviations** as follows and press **Apply**.

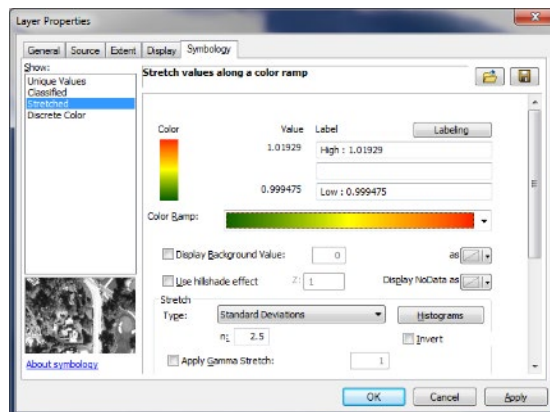

In the **Table of Contents**, drag the chart layer above the Bath_alg layer. It now possible to compare the algorithm results with the chart

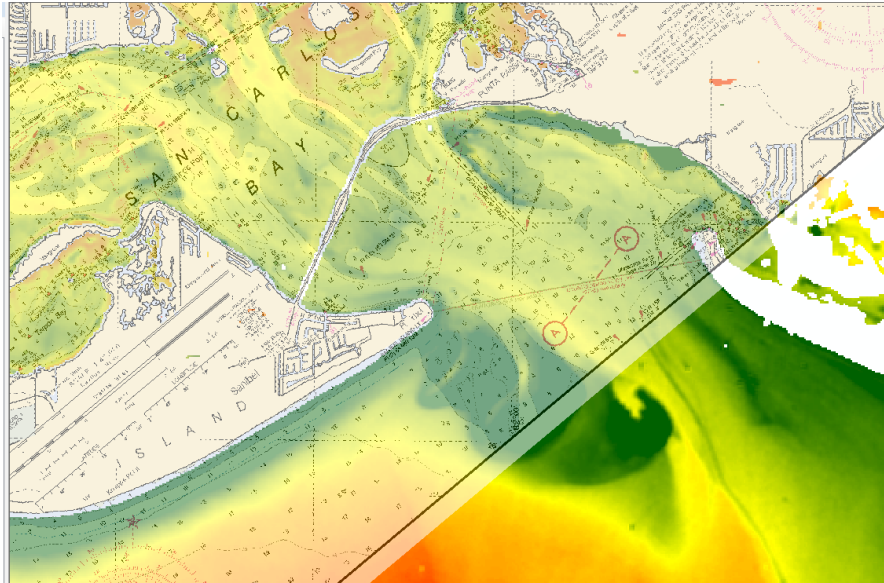

14.4.3 SDB – Vertical referencing and depth of extinction calculation

Note: There are two options for referencing the algorithm result to the chart datum: 1) referencing using S-57 attributes from an ENC, or 2) manually calculating the gain and offset using a raster chart. It is recommended to use option 1 when possible, as it provides a fast and accurate solution. As a byproduct of the referencing procedure, the effective depth of the bathymetry (i.e., depth of extinction) is calculated.

Turn on the survey sounding point feature over the algorithm result.

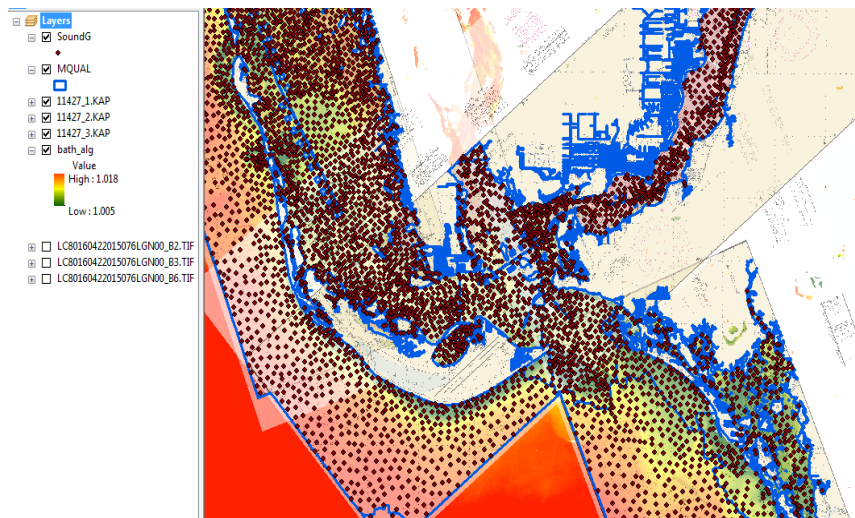

In order to NOT select soundings over “false bathymetry” caused by sediment turbulence, a polygon will be created based on a visual inspection of the algorithm layer. In **ArcCatalog**,

select the file geodatabase in the Data directory folder. Create a new feature class, right-click the geodatabase and select **New** then **Feature Class**.

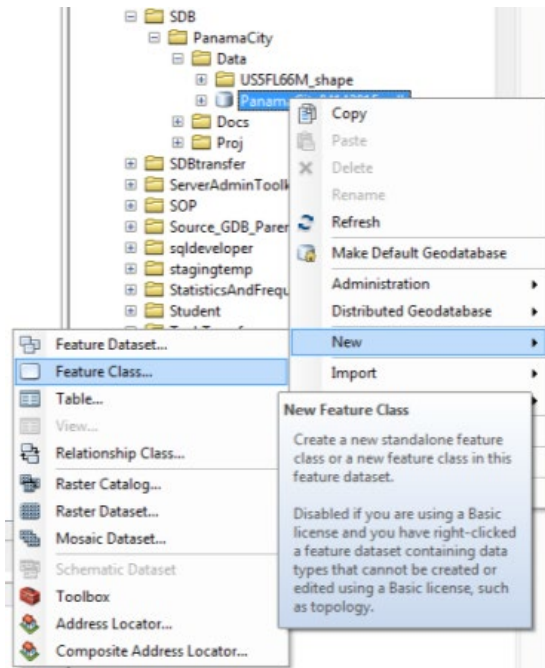

Name the file "ref_mask", select **Polygon Features** as the feature type. Click **Next**.

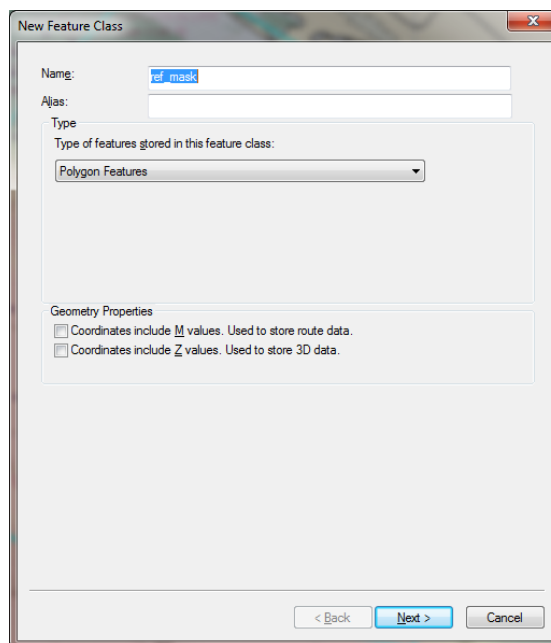

Select a coordinate system from the **Layers** dropdown. Click **Next** three more times and then click **Finish**.

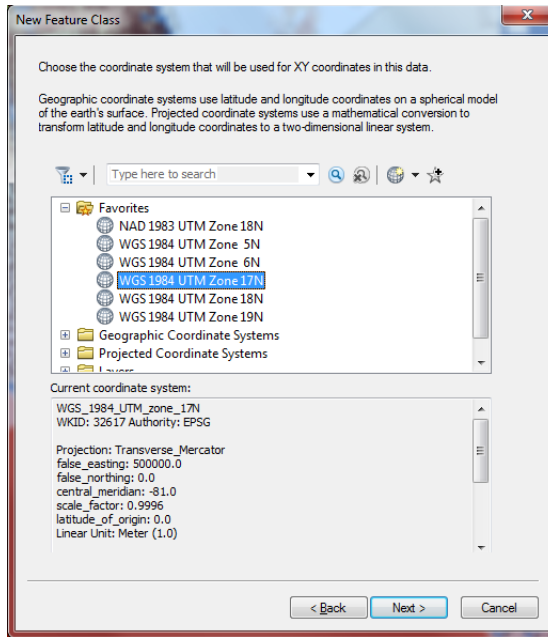

Right-click the ref_mask layer and select **Edit Features** then **Start Editing**.

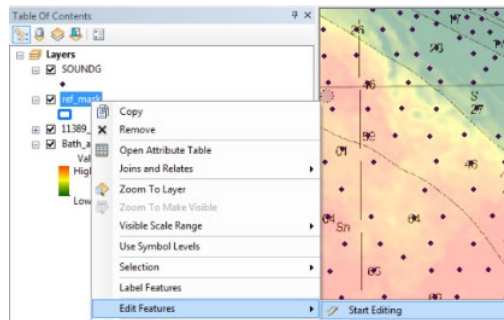

You may get the following message, press **Continue**.

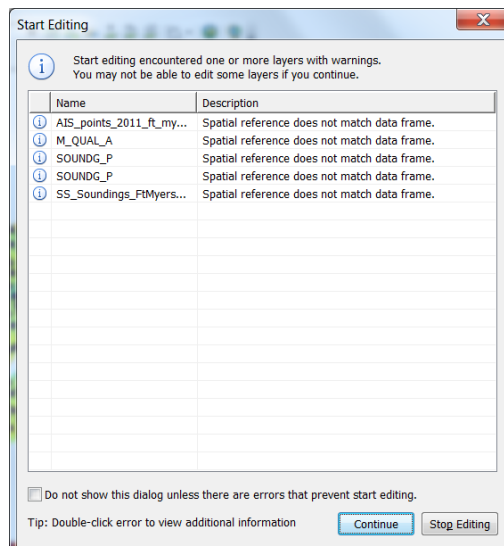

In the **Create Features** window, select the *Ref_mask* feature and select the **Polygon** option in the **Construction Tools** window.

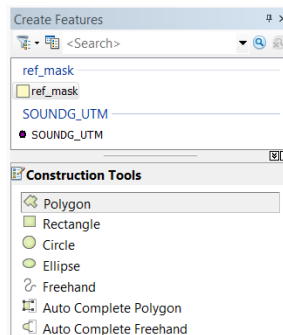

Note: In case the **Create Features** window appear automatically, select the **Create Features** icon from the **Editor** toolbar.



Digitize the areas considered clean from sediment plumes by visually determining a polygon around the clean area.

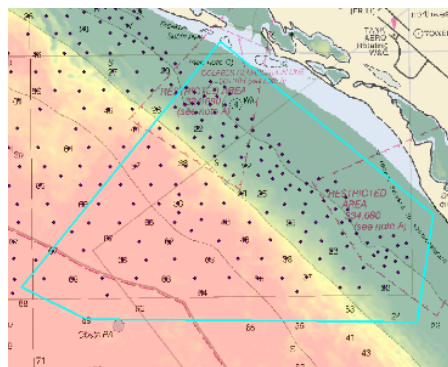

In the **Editor** toolbar, select **Save Edits** and then select **Stop Editing**.

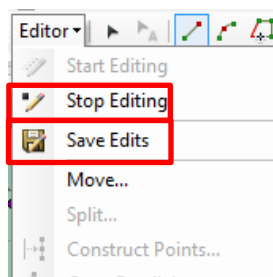

In **ArcToolbox**, select **Analysis Tools/Extract/Clip**.

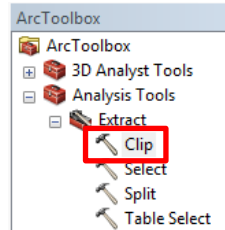

For the **Input Features** select the point feature file (SOUNDG), *ref_mask* for the **Clip Features** select and name the output feature class to *points_extract*.

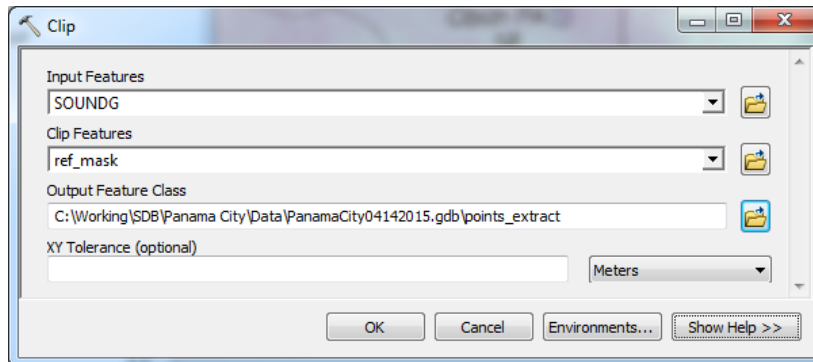

In **ArcToolbox** select **Spatial Analyst Tools/Extraction/Extract Values to Points**. This function will allow to sample the algorithm result based on the point feature (*point_extract*).

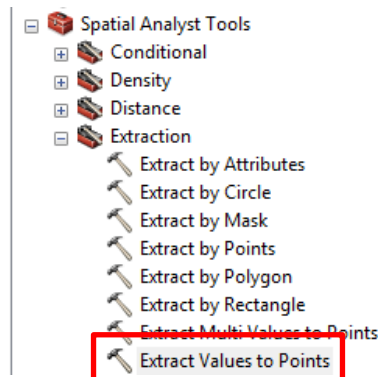

Select *points_extract* for **Input point features**. Select the algorithm results (*Bath_alg*) for **Input raster**. Rename the output feature class to *point_alg* and press **OK**.

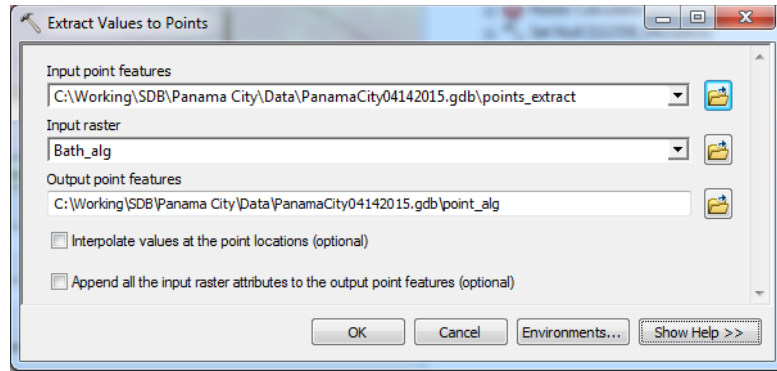

Right-click the *point_alg* layer and select **Properties** and select the **Fields** tab.

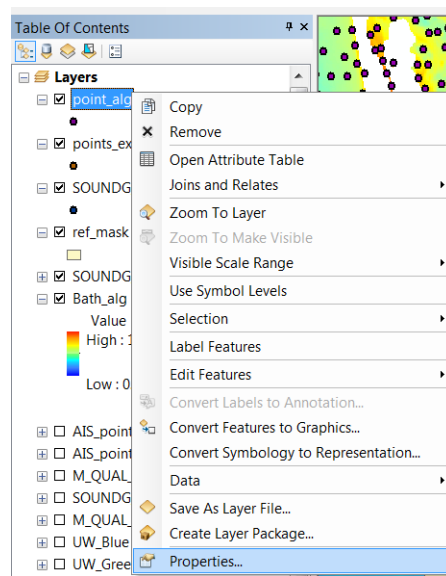

Turn the visibility off for every field except the depth measurements in meters (DEPTH_M) and the algorithm results column (RASTERVALU). To turn a field off, click the checkboxes off and click **OK**.

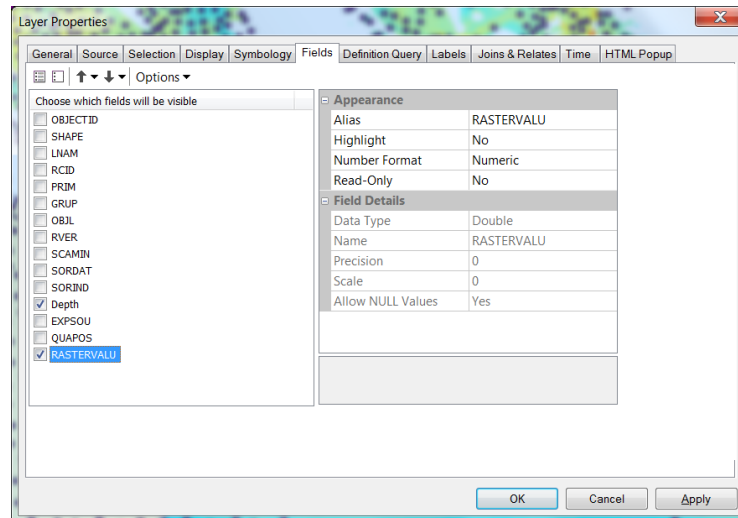

Right-click the *point_alg* layer and select **Open Attribute Table**.

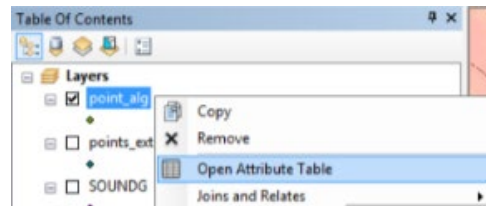

The attribute table should contain only the depth column and the RASTERVALU column.

DEPTH_M	RASTERVALU
5.4	1.01436
6	1.015355
5.1	1.014404
19.8	1.019569
5.7	1.013836
5.7	1.014791
5.7	1.014463
17	1.019472
21	1.01942
10.9	1.018664
5.1	1.014239
6.4	1.015377
14.3	1.019204
14.6	1.019186

Open the **Table Options** in the **Table** window and select **Export**.

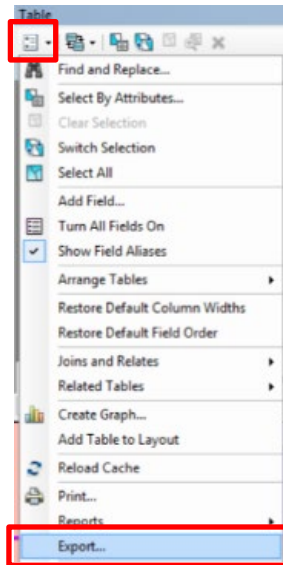

Select a destination folder to save the exported data through the Browse folder icon.

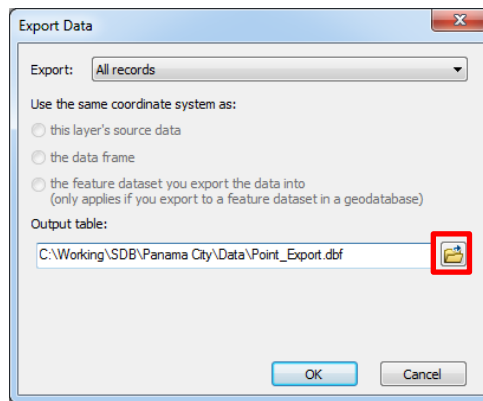

Switch the save as type to dBASE Table and name the file Point_Export.

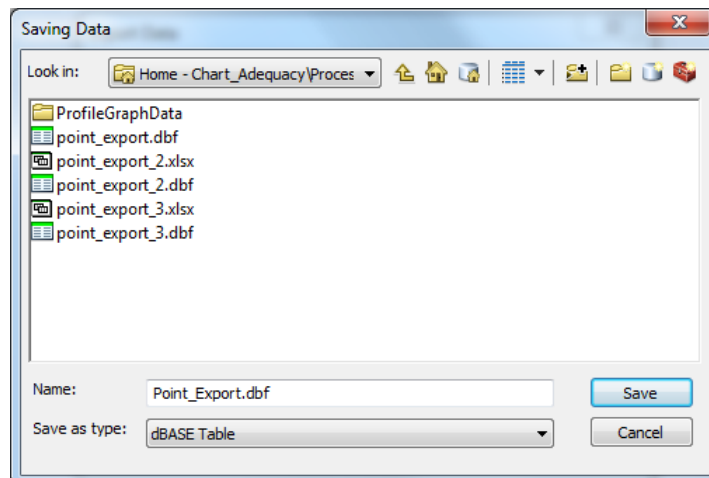

Select **No** when it asks to add the new table to the current map.

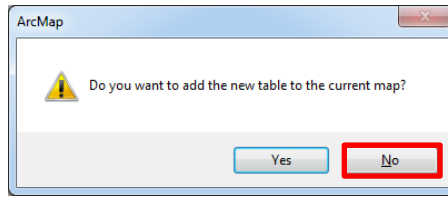

Note: The next steps are in MS Excel.

Open MS Excel.



Open the saved "*Point_Export.dbf*" file in MS Excel. In the **Data** tab, select **Sort**.

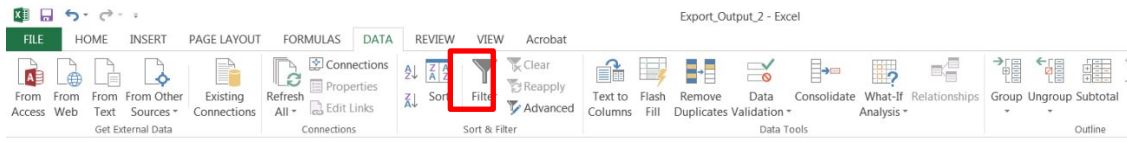

In the **Sort** window, Select *RASTERVALU* as the **Column** and *Smallest to Largest* as the **Order**. Press **OK**.

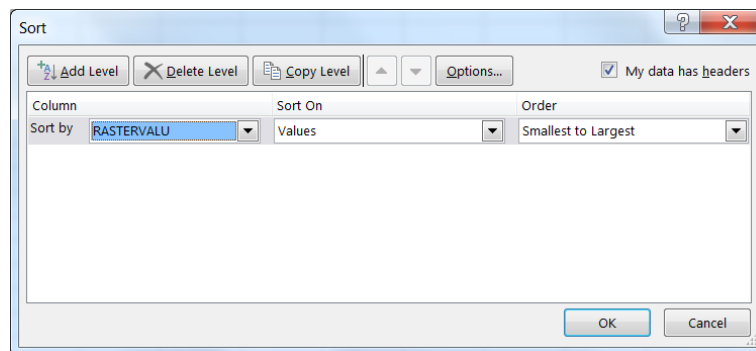

For any value of -9999 (this represents no data) select both the **RASTERVALU** cell and the corresponding **Depth** cell. Delete all of those sets of cells by right-clicking the highlighted cells and selecting delete. Then select shift cells up.

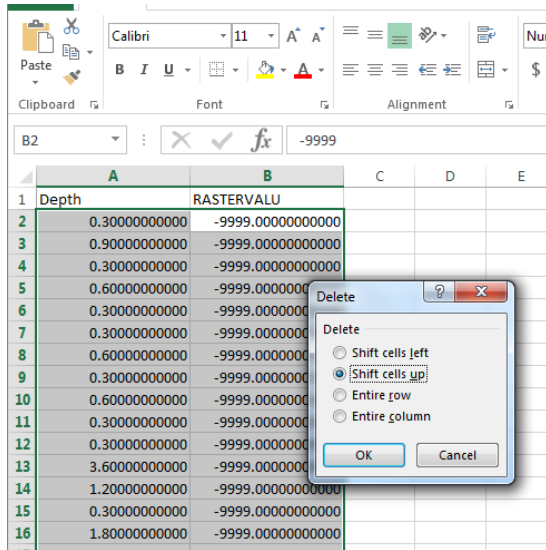

Select again **Sort** in the **Data** tab.

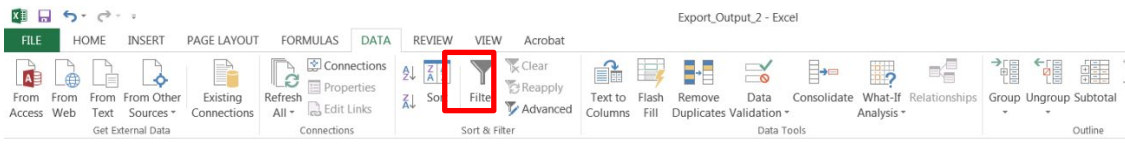

In the **Sort** window, select *Depth* as the **Column** and *Smallest to Largest* as the **Order**. Press **OK**.

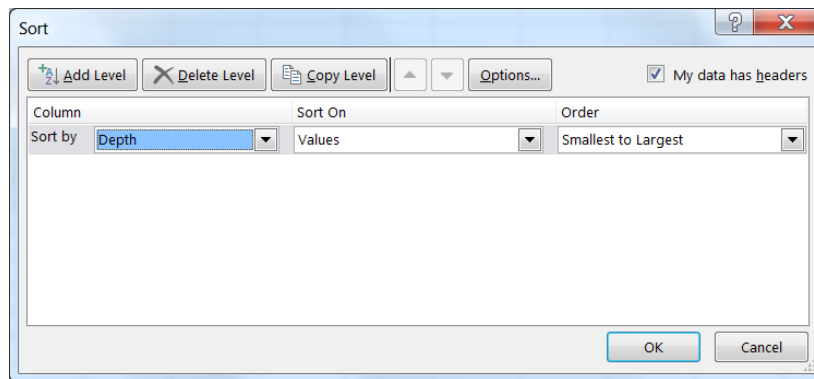

Note: In case of using survey data, make sure to round the depth values to one decimal point. Otherwise, each depth point might have its own unique value.

Select the **Advanced** option under the **Data** tab.

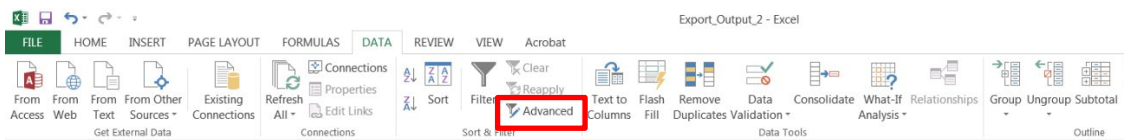

The default **Advanced Filter** window will show the cell range of the whole dataset. Modify the **List range** to only the A column, type **Copy to: E:E**, check the **Unique records only** box, and press **OK**.

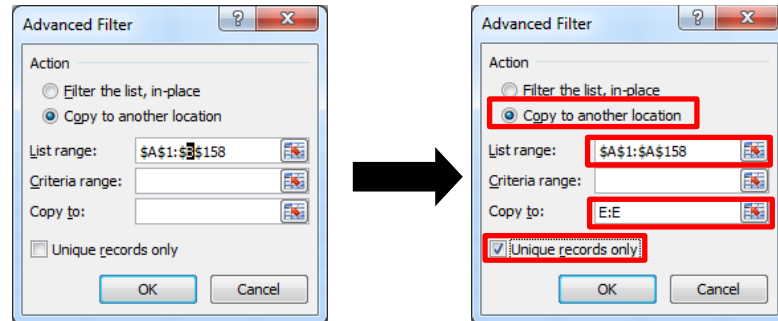

Column E will have all the depth values organized.

	A	B	C	D	E	F
1	DEPTH_M	RASTERVALU			DEPTH_M	
2	4.50000000000	1.01386141777			4.5	
3	5.10000000000	1.01440405846			5.1	
4	5.10000000000	1.01423859596			5.4	
5	5.10000000000	1.01387035847			5.7	
6	5.10000000000	1.01426672935			6.0	
7	5.10000000000	1.01437878609			6.4	
8	5.10000000000	1.01422977448			6.7	

Type in cell D1 the text *Average*, and type the following term in cell D2: $=AVERAGEIF(A:A,E2,B:B)$ and press **Enter**.

	A	B	C	D	E	F
1	Depth	RASTERVALU		Average	Depth	
2	0.1	1.00370049477		1.006927	0.1	
3	0.1	1.01015424728			0.3	
4	0.3	1.00115084648			0.6	
5	0.3	1.00124955177			0.9	

Drag the results of the cell D2 (bottom right corner) down to the end of the depth value list (Column E).

	A	B	C	D	E
1	Depth	RASTERVALU		Average	Depth
2	0.1	1.00370049477		1.00693	0.1
3	0.1	1.01015424728		1.0069	0.3
4	0.3	1.00115084648		1.00568	0.6
5	0.3	1.00124955177		1.00442	0.9

Select Columns D and E. Under the **Insert** tab, select **Scatter/Scatter with only Markers**.

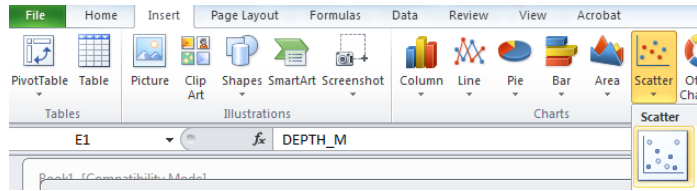

The results will show a linear line at shallow depth that start to curve vertically at deeper water values. Identify the curve value and mark it in you file sheet as the “Extinction Depth” (Although the image show an extinction value up to 13 m, we will use 8.8 m in this example).

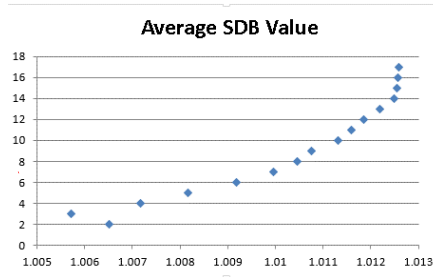

Note: The x-axis is the SDB result and the y-axis is the charted depth.

Select all the depth values and SDB values from columns D and E that are below the Extinction Depth (it also recommended to start at depth values above 1 to 2 m, depending on the site).

Average	Depth
1.00693	0.1
1.0069	0.3
1.00568	0.6
1.00442	0.9
1.00379	1.2
1.00611	1.5
1.0029	1.8
1.00369	2.1
1.0059	2.4
1.00766	2.7
1.00696	3.0
1.00761	3.3
1.00873	3.6
1.00917	3.9
1.012	4.2
1.01101	4.5
1.01301	4.8
1.01308	5.1
1.01394	5.4
1.01446	5.7
1.01481	6.0
1.01563	6.4
1.01583	6.7
1.01638	7.0
1.01661	7.3
1.01721	7.6
1.0174	7.9
1.01773	8.2
1.0181	8.5
1.01842	8.8

Select again **Scatter/Scatter with only Markers**, located under the **Insert** tab.

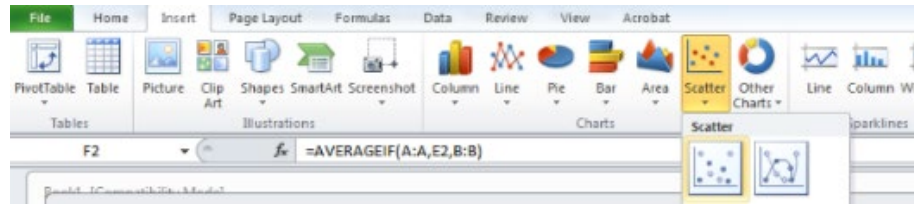

You will receive a scatter plot that will be a linear line, right click on one of the markers and select **Add Trendline...** .

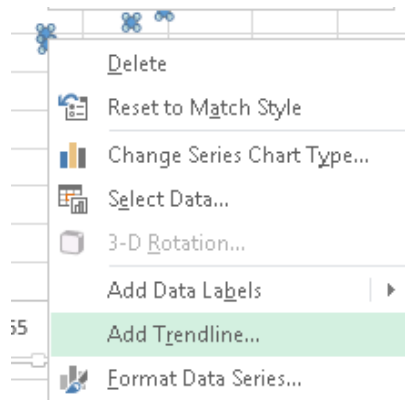

Make sure the regression type is linear. Check the **Display Equation on Chart** and **Display R-squared value on chart** boxes and press **Close**.

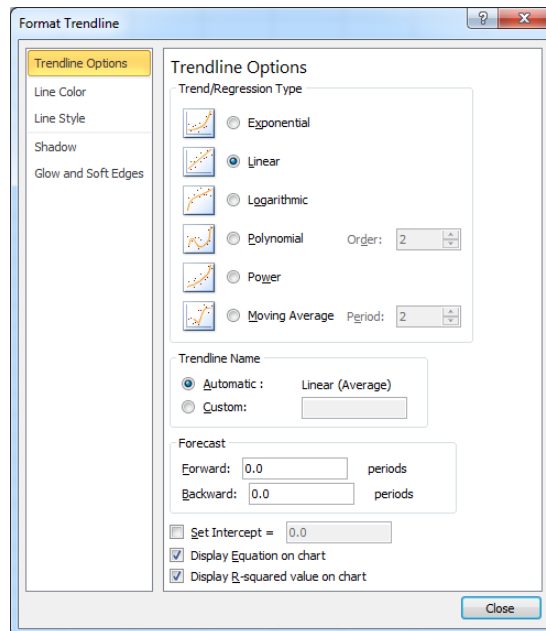

The resulting equation of the trend line is used for the referencing (in this example, the gain is 458.37 and the offset is -458.82).

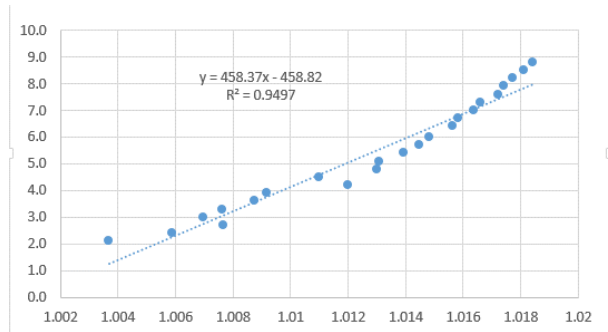

Save the Excel Spread sheet into the Data directory as *Extinction_Depth.xlsx*. (Excel Workbook in Excel 2007).

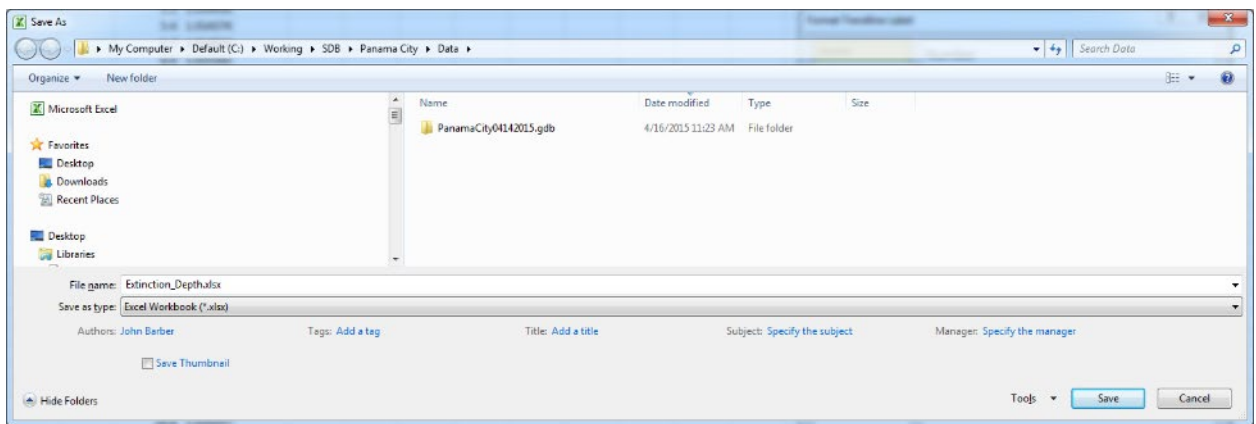

14.4.4 SDB – Applying the gain and offset (referencing)

In ArcMap, select in the ArcToolbox Spatial Analyst Tools/Map Algebra/Raster Calculator.

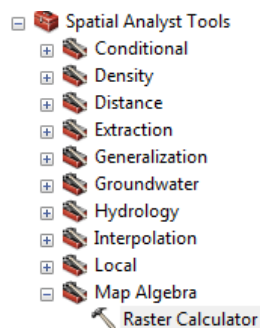

Select the algorithm layer and multiply the algorithm layer by the gain value from the excel sheet, and then subtract the offset value. Save the file as "*calc_bathy*" and press **OK**.

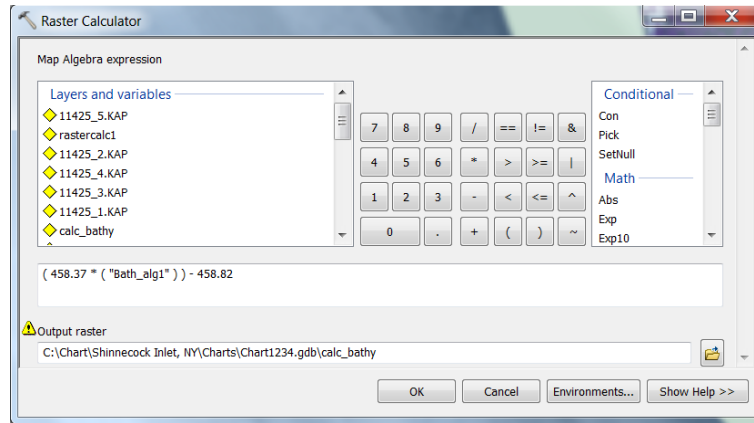

Using the Identify button click on a few “point_alg” point (make sure that **Identify from: Visible layers**) and compare the values.

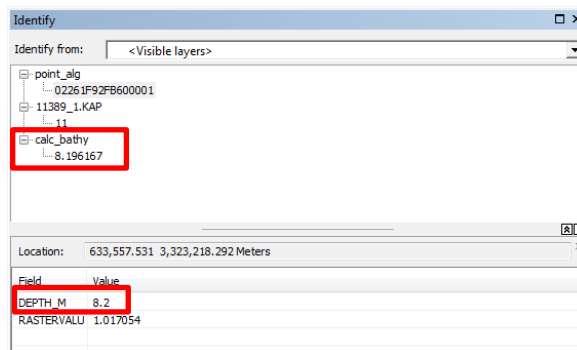

14.4.5 Generating contour lines (based on the largest-scale chart available)

Select the ArcToolbox Spatial Analyst Tools/Surface/Contour List.

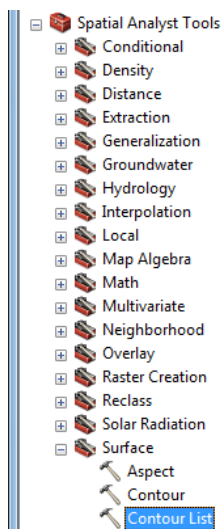

Type in the **Contour List** window the **Contour values** that match the largest-scale chart available in area. Make sure that the depth are in meter (if the chart contours are in feet or fathoms, then convert those measurements to meters) and press **OK**.

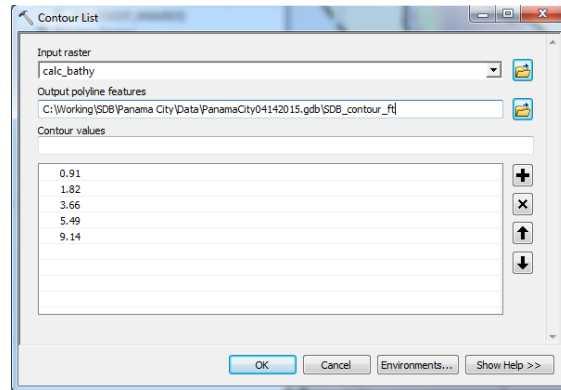

The contour layer should be inspected with respect to the contour lines of the chart.

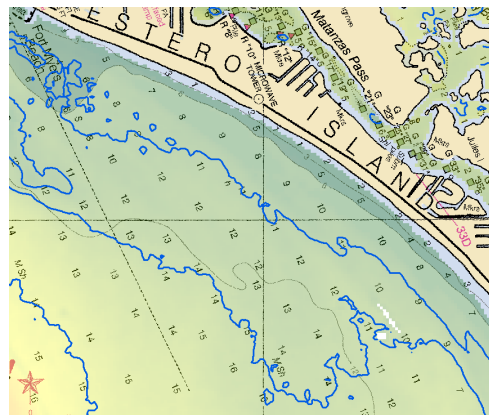

14.4.6 Comparing between the derived and the charted bathymetry

Turn on the derived bathymetry and the contour list over the RNC. Notice if there are any discrepancies between the two (in the case, marked in red circles).

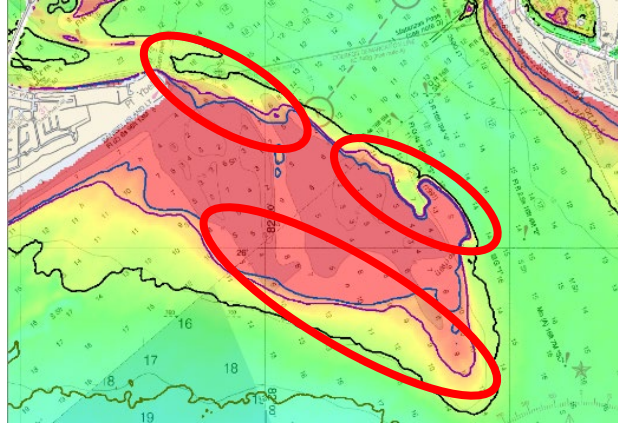

In **ArcCatalog**, select the file geodatabase in the Data directory folder. To create a new feature class, right-click the geodatabase and select **New** then **Feature Class**.

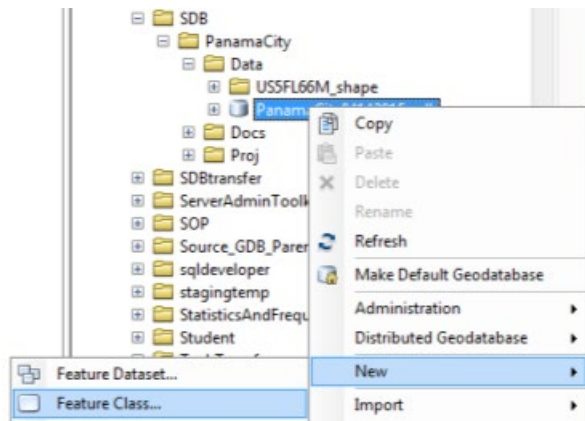

Name the file "Bath_Diff", select **Polygon Features** as the feature type. Click **Next**.

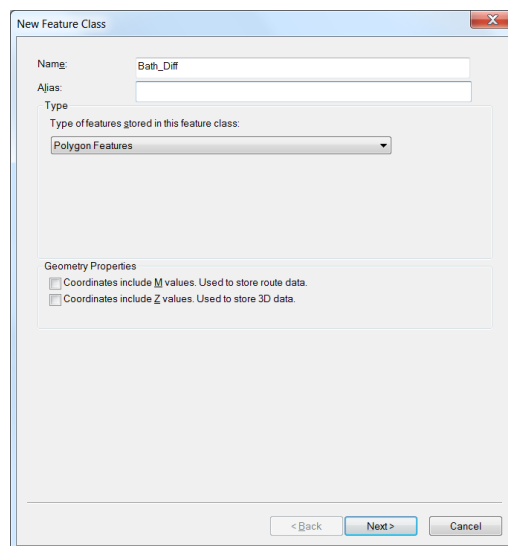

Confirm that the coordinate system matches the UTM projection of the project. Click **Next** three more times and then click **Finish**.

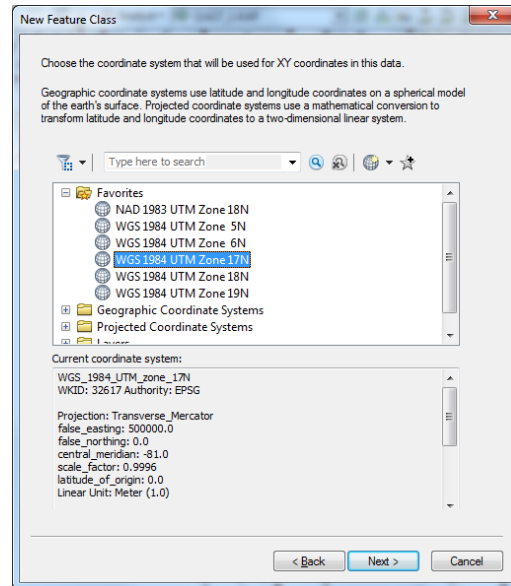

Right-click the Bath_Diff layer and select **Edit Features** then **Start Editing**.

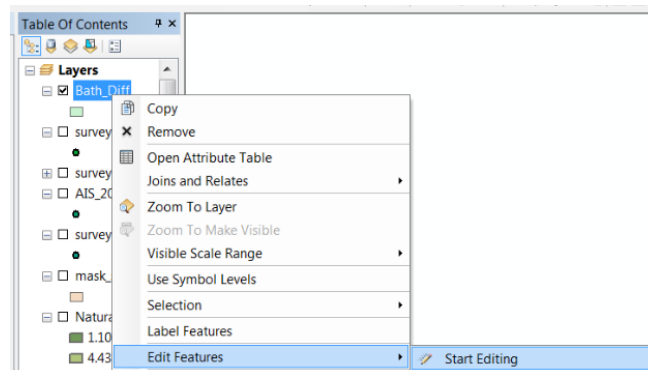

You may get the following message, press **Continue**.

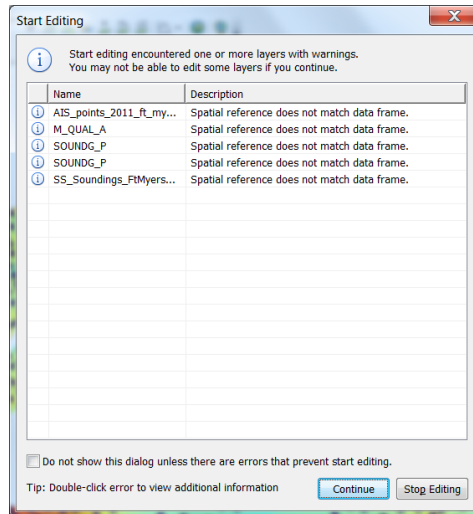

In the **Create Features** window, select the *Ref_mask* feature and select the **Polygon** option in the **Construction Tools** window.

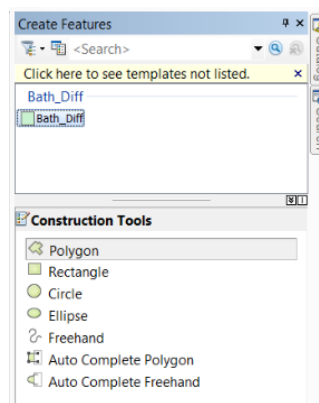

Note: In case the **Create Features** window does not appear automatically, select the **Create Features** icon from the **Editor** toolbar.



Roughly, digitize around the whole bottom feature that does not match between the chart and the derived bathymetry (any discrepancy between the SDB and the chart).

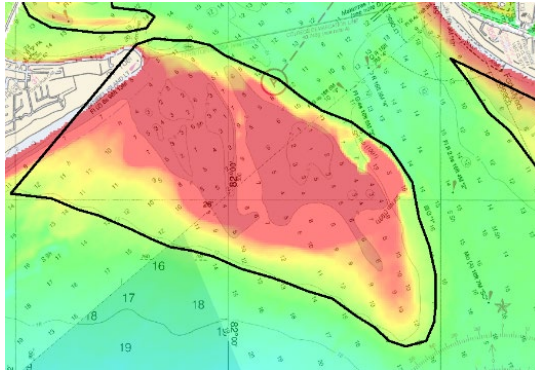

In the **Editor** toolbar, select **Save Edits** and then select **Stop Editing**. The Bath_Diff layer now contained the areas that have changes since the last survey used for the chart.

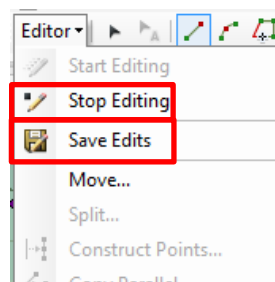

Right-click the *Bath_Diff* layer and select **Open Attribute Table**.

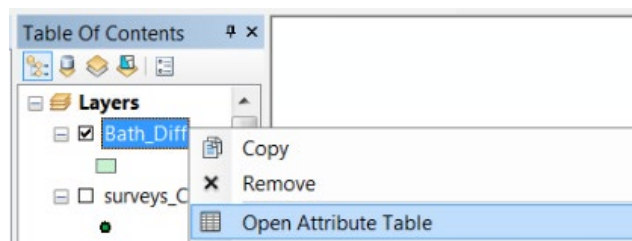

Open the **Table Options** in the **Table** window and select **Add Field...**

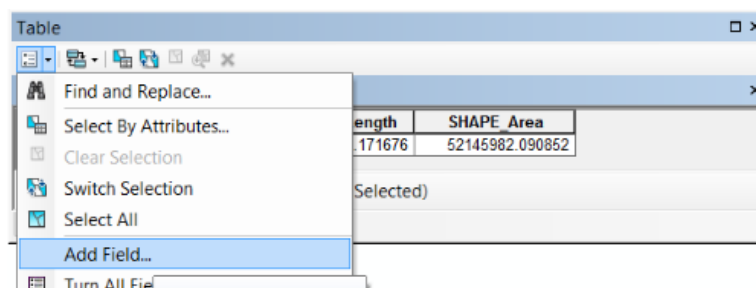

In the Add Field window, type **Name: BD** and press **OK**.

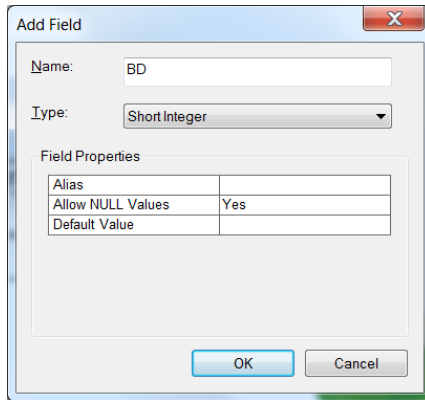

A new field was added to the Table.

OBJECTID *	SHAPE *	SHAPE_Length	SHAPE_Area	BD
1	Polygon	29132.171676	52145982.090852	<Null>

Right-click again on the Bath_Diff layer and select **Edit Features** then **Start Editing**.

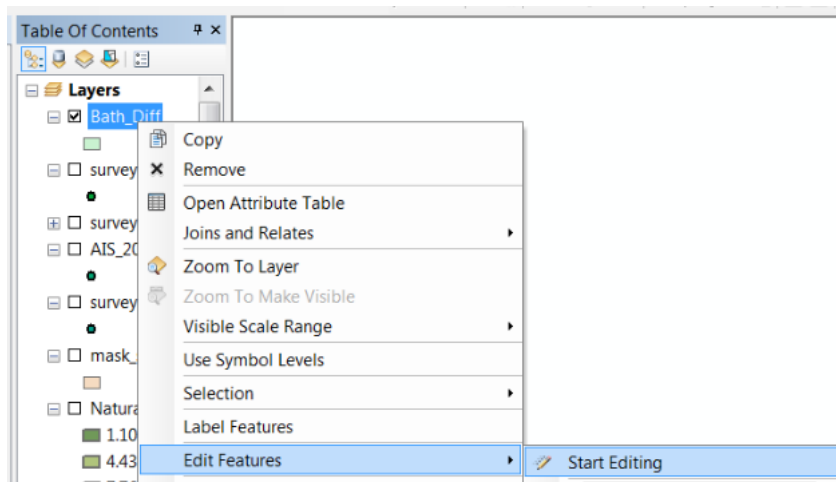

Type the value “10” in the BD column for each of the polygons..

OBJECTID *	SHAPE *	SHAPE_Length	SHAPE_Area	BD
1	Polygon	29132.171676	52145982.090852	10

In the **Editor** toolbar, select **Save Edits** and then select **Stop Editing**. The Bath_Diff layer now contained the areas that have changes since the last survey used for the chart.

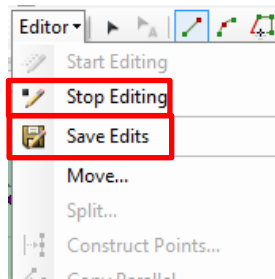

Select **Con** toolbox, in **Spatial Analyst Tools/Conditional**.

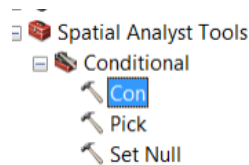

In the **Con** window, select **Ref_Surface** for Input conditional raster, then use the following Expression: “value < 1000”. Type “0” as the Input true constant data, output raster as “**Background**” and press **OK**.

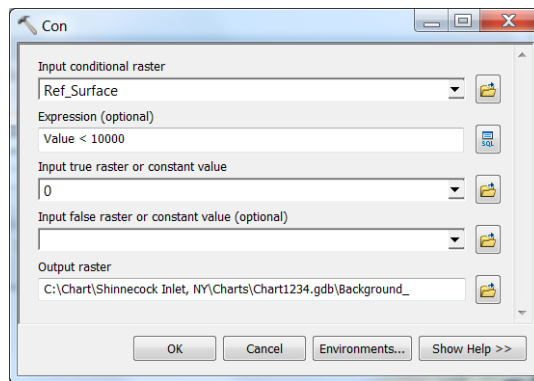

Select **Conversion Tools/From Raster/Raster to Polygon**.

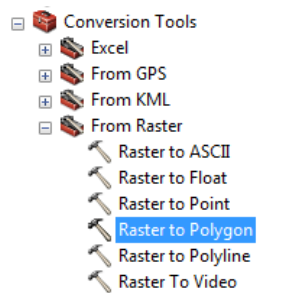

In the **Raster to Polygon** window, select **Background** for the input raster, make sure that the **Field** is **Value**, and the output polygon feature is **Background_Poly**, and uncheck **Simplify polygons**, and press **OK**.

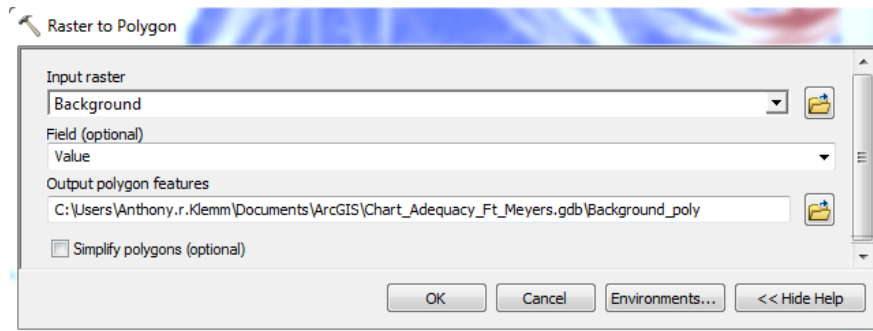

Select **Union** toolbox, in **Analysis Tools/Overlay**.

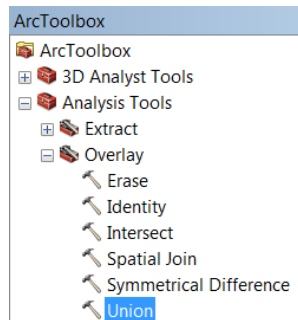

In the **Union** window, make sure to load the **Bath_Diff** layer over the **Background_Poly** layer and press **OK**. Name the output **merge**.

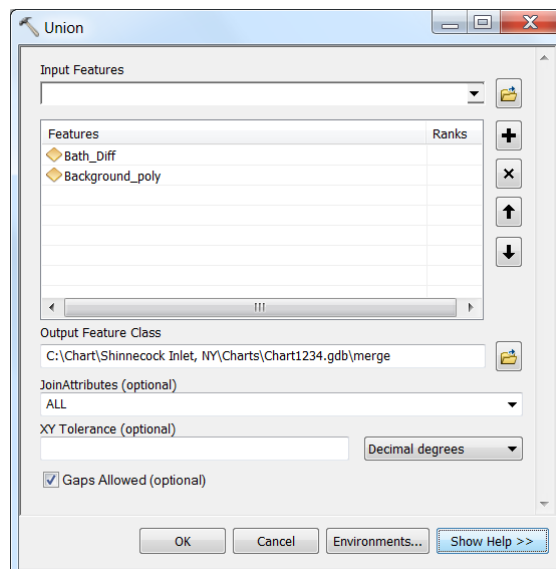

Right-click the *merge* layer and select **Open Attribute Table**.

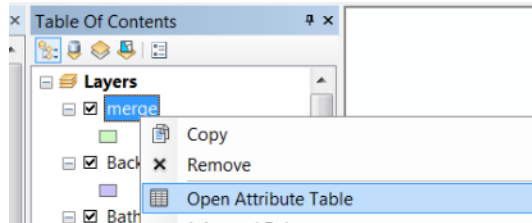

Validate that the BD column in the **Table** of the **Merge** file contains a “10” value for the marked polygons and “0” for the background.

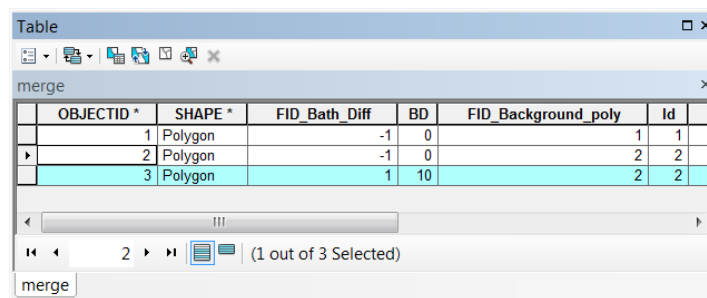

OBJECTID *	SHAPE *	FID_Bath_Diff	BD	FID_Background_poly	Id
1	Polygon	-1	0	1	1
2	Polygon	-1	0	2	2
3	Polygon	1	10	2	2

Note: Make sure that both the Bath_Diff and the background layers are projected in a Cartesian datum (e.g., Transverse Mercator or Universal Transverse Mercator). Otherwise, use **Data Management Tool/ Projection and Transformations/Project** to convert the polygons into Cartesian datum.

Select **Polygon to Raster**, in ArcToolbox/Conversion Tools/To Raster.

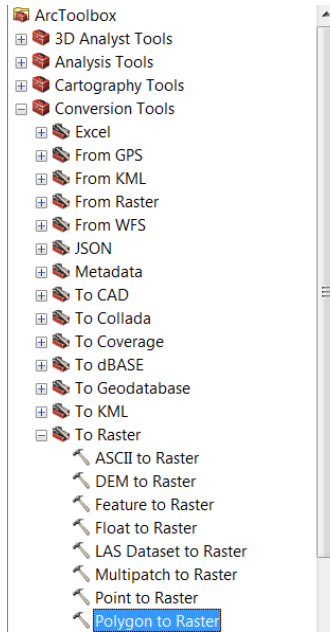

In **Polygon to Raster** window, select **merge** as the Input Features, **BD** as the **Value field**, the **Cellsize** as **30m** and press **OK**.

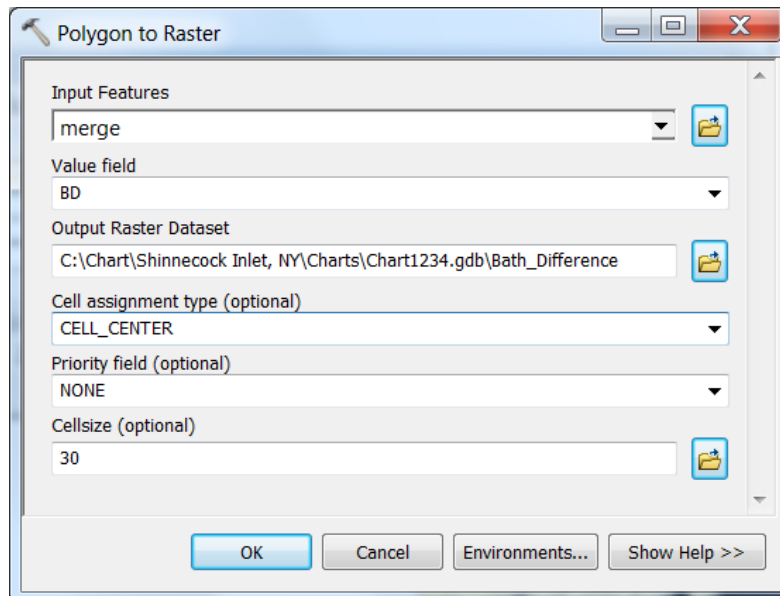

The resulting layer should be a thematic map of the bathymetric difference.

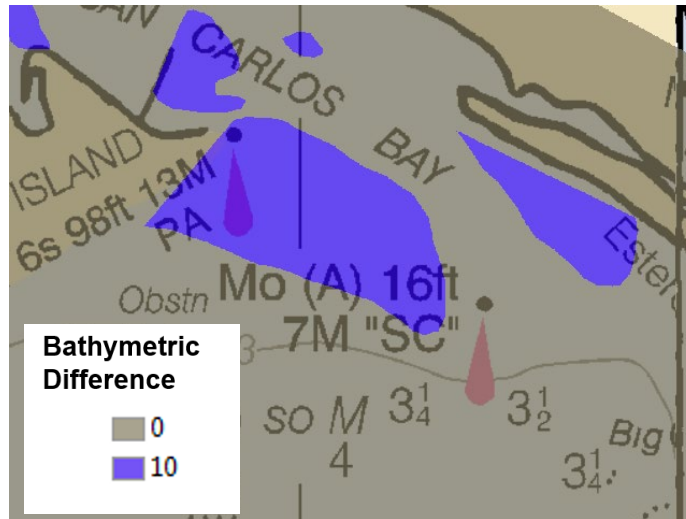

Save the project by selecting **File/Save** in the main menu.

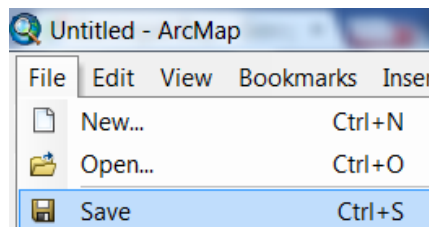

14.5 Vessel Traffic layer

14.5.1 Calculating the traffic density

Using a web browser (e.g., Google Chrome, MS Internet explorer, etc.), download the Track Builder Script from the following webpage: <http://marinecadastre.gov/ais/> .

The Tools

Track Builder Script

This tool converts a collection of point features into a track line. The input data must include date and time values for each point and an identifier to group points in a line. It is designed to work with data available from MarineCadastre.gov but will also function with other feature classes that contain a DateTime field and a unique identifier. When used with MarineCadastre.gov-formatted data, the tool also offers a function to extract vessel and voyage attributes from related tables for each line.

Technical Specifications

1. ArcGIS Toolbox ArcPy script designed for ArcGIS for Desktop 10.1 and 10.2
2. ArcGIS for Desktop Standard or Advanced license required for relationship class functionality

[View Tutorial](#) [Download](#)

Extract the *.zip (currently, TrackBuiderVersion2.zip) to a local directory on your computer or server.

In the ArcToolbox window, right-click on the main ArcToolbox directory.

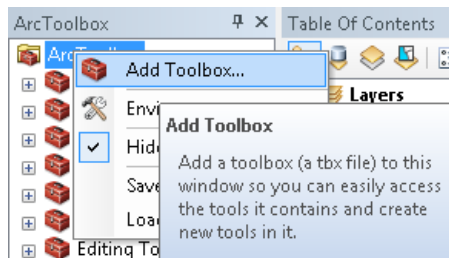

In the **AddToolbox** Window, navigate to your local directory and select **TrackBuilder.tbx** and press **Open**.

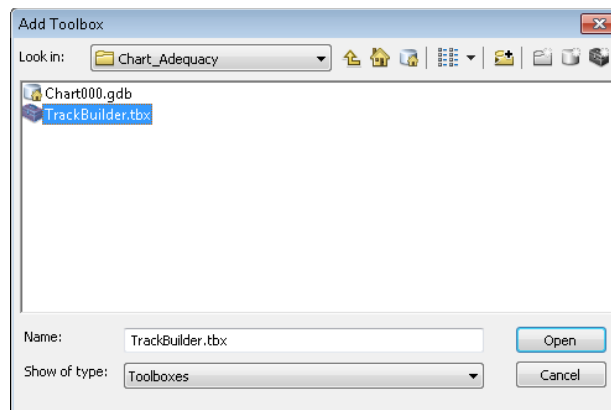

The **TrackBuilder** toolbox will be added to the **Toolbox** window. Select **Track Builder V2** from the toolbox

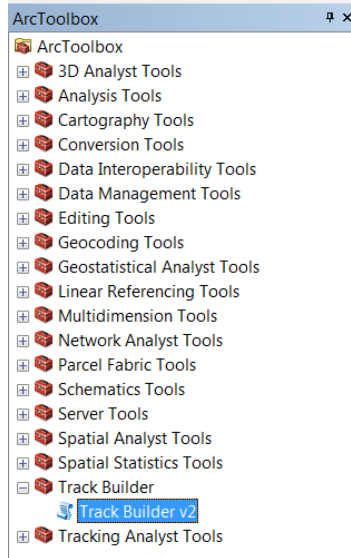

In the **Track Builder** Window, select the AIS point feature file (“*AIS_points_UTM*”) as **Input Points**, **MMSI** as the **ID Field**, **BASEDATETIME** as the **DateTime Field**, **Maximum Time and Distance** for the **Break Track Lines using**, “**20**” for the **Maximum Time (minutes)**, “**2**” for the **Maximum Distance (miles)** and press **OK**.

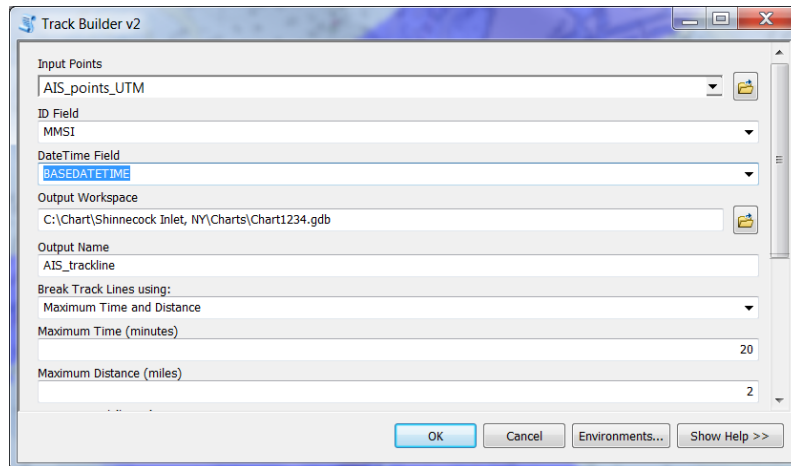

Select **Line Density**, under **ArcToolbox/Spatial Analyst Tools/Density**.

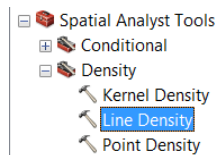

In the **Kernel Density** window, select the *AIS_Trackline* line feature as **Input point or polyline features**, “30” as the **Output cell size**, “300” as the **Search Radius**, *SQUARE_METERS* as the **Area units**, and press **OK**.

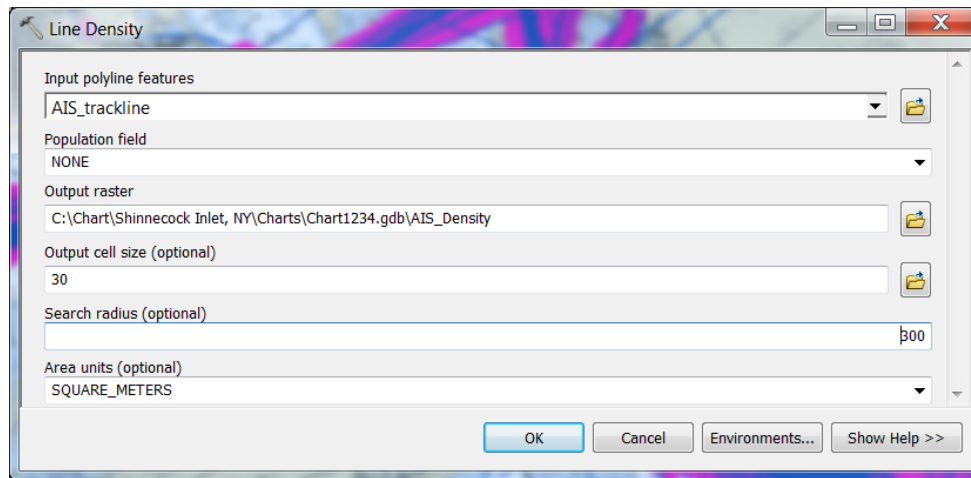

14.5.2 Generating the Vessel Traffic layer

Select **Con** toolbox, in **Spatial Analyst Tools/Conditional**.

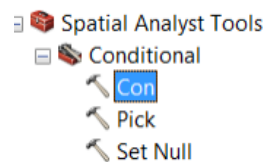

In the **Con** window select *AIS_density* for the **Input raster**, type the following **Expression**: “value > 0.0044”. Type “1” as the **Input true raster or constant value** and “0” for the **Input false raster**. Save the output raster as “*Vessel_Traffic*”.

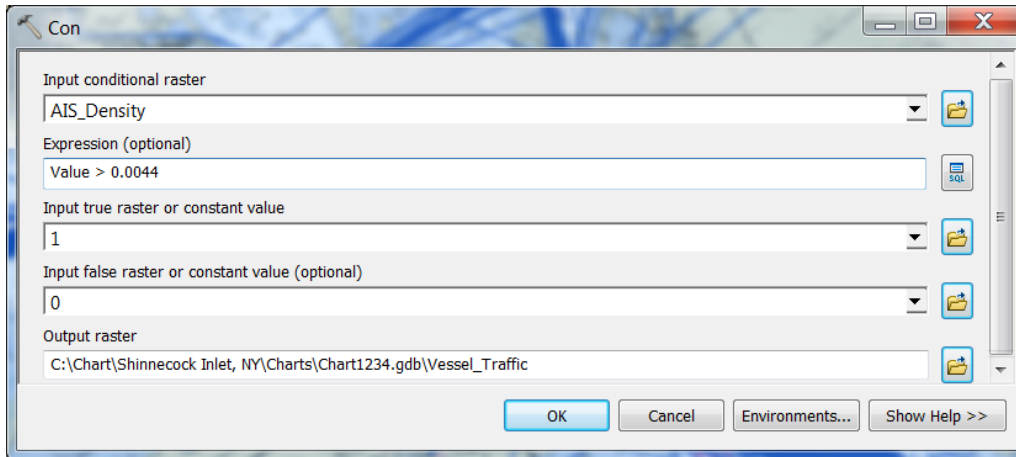

The resulting layer is a thematic map of the vessel traffic.

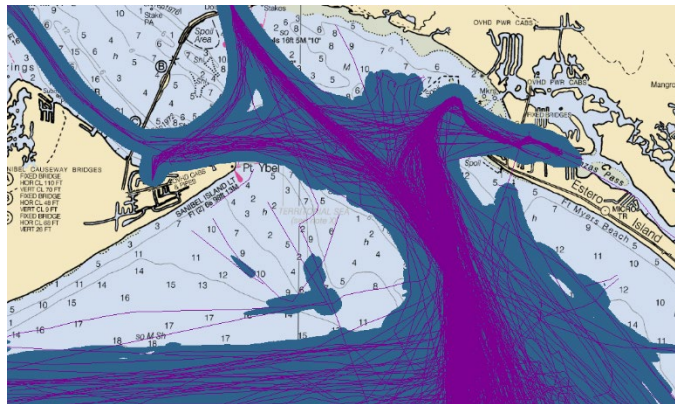

Select **Conversion Tools/From Raster/Raster to Polygon**.

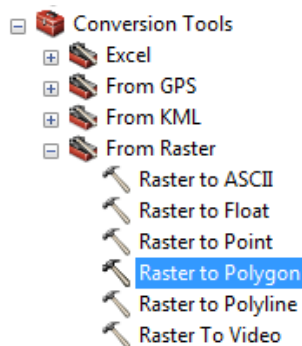

In the **Raster to Polygon** window, select *Vessel_Traffic* for the input raster, make sure that the **Field** is **Value**, and the **output polygon feature** is *VT_poly*, and uncheck **Simplify polygons**, and press **OK**.

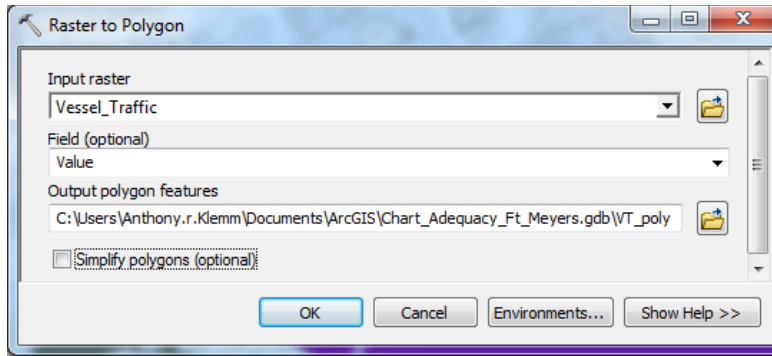

Save the project by selecting **File/Save** in the main menu.

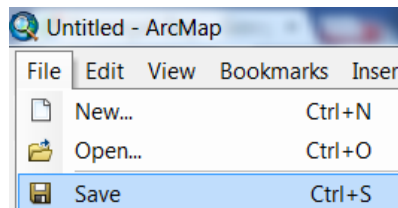

14.6 Hydrographic Characteristics layer

14.6.1 Validation of CATZOC encoding in the MQUAL S-57 attribute

In the **Table Of Contents** window, right-click on the *M_QUAL_UTM* layer and select **Open Attribute Table...**

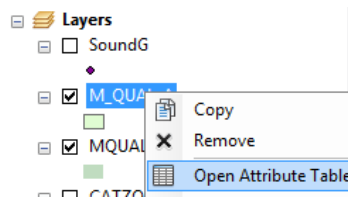

If the MQUAL layer has multiple polygons with varying CATZOC values, then Skip to 6.1.4.

Note: Multiple polygons MQUAL layer is the default source of information to create the H.C. thematic map.

FID	Shape *	OBJECTID	LNAM	RCID	PRIM	GRUP	OBJL	RVER	CATZOC	SUREND	SURSTA	TXT
0	Polygon	0	US082592147600009	5624	3	2	308	1	zone of confidence B	1959	1950	USSFL1
1	Polygon	1	US090844485000009	5625	3	2	308	1	zone of confidence B	1959	1950	USSFL1
2	Polygon	2	US064103203300009	5626	3	2	308	1	zone of confidence B	1959	1950	USSFL1
3	Polygon	3	US054535749500009	5627	3	2	308	1	zone of confidence B	1959	1950	USSFL1
4	Polygon	4	US022424786900009	5802	3	2	308	1	zone of confidence B	1959	1950	USSFL1
5	Polygon	5	US089340824400009	5803	3	2	308	1	zone of confidence B	1959	1950	USSFL1
6	Polygon	6	US053840064200009	5815	3	2	308	3	zone of confidence U (data not assessed)			USSFL1

If the MQUAL layer has only has one or two polygons and the CATZOC is encoded as “*zone of confidence U (data not assessed)*,” or has not yet been encoded, then it is recommended to use the source layer from an RNC in order to generate a hydrographic characteristic polygon(See SDB procedure – Chapter 11, Appendix B) in addition to 6.1.4.

OBJECTID	SHAPE *	LNAM	RCID	PRIM	GRUP	OBJL	RVER	CATZOC	SORDAT	SORIND
0	Polygon	US016327304504335	6641	3	2	308	1	zone of confidence U (data not assessed)	20060300	US,US_graph,Chart 12352

If some cases historical hydrographic survey outlines and metadata are available (skip to 6.2). If available, click **Add Data**.



Navigate to the survey outlines file into your workspace in the **Add Data** window, select the survey outlines file and click **Add**.

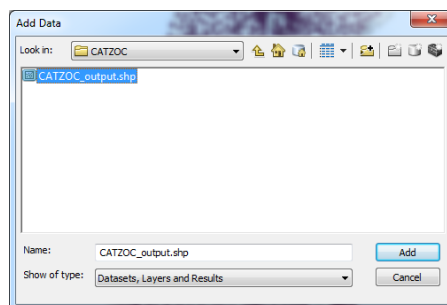

In some cases the most current surveys outlines file will cover an area larger than your area of interest, you can clip the current survey outlines file to the MQUAL. Select **Clip** from the **Geoprocessing** tab.

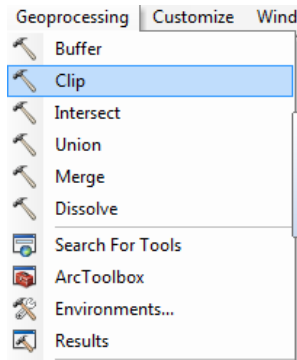

In the **Clip** window, select the current surveys outlines file as the **Input Features** and the **M_QUAL_UTM** of the chart you are evaluating as the **Clip Features**. Save the feature class as “M_QUAL_UTM_Clip” to your Default Geodatabase and press **OK**.

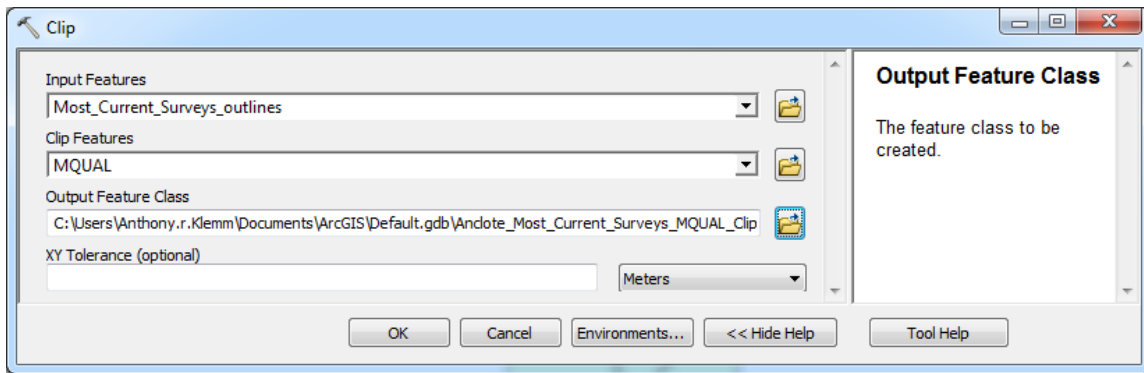

Note: The MQUAL file in next steps will describe as “M_QUAL_UTM”. If a current surveys outline file was available, then use “M_QUAL_UTM_clip”.

14.6.2 Input H.C. values using the H.C. Look-up Table

Right-click on the **M_QUAL_UTM_clip** layer and select **Open Attribute Table...** in the **Table Of Contents** window.

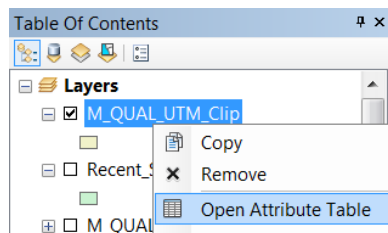

In the **Table** window, click **Table Options > Add Field...**

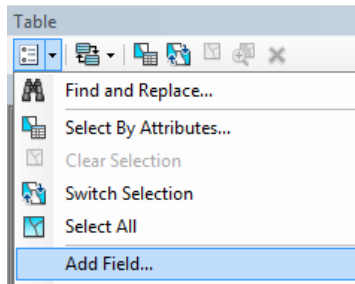

In the **Add Field** window, type: Name: “**HC**”, select Type: **Short Integer** and press **OK**.

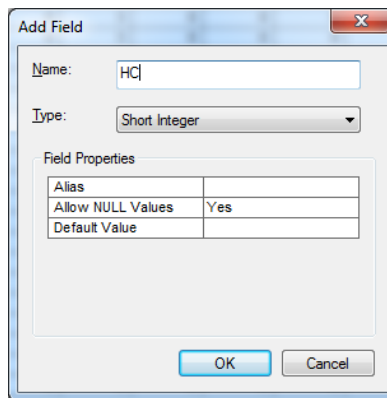

In the **Table of Contents**, right-click on the *M_QUAL_UTM_clip* layer and select **Edit Features > Start Editing**.

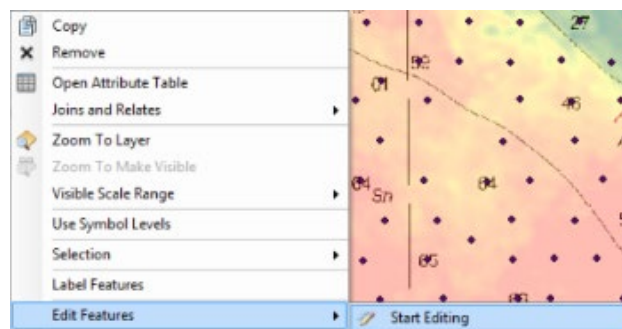

Type the HC rank (Table 14.1 in the Introduction) based on the Technique of Soundings (TECSOU) IHO code (Table 14.2) and the survey dates, type.

OBJECTID_1*	Shape*	CATZOC	SUREND	SURSTA	TECSOU	SORDAT	SORIND	Shape_Length	Shape_Area	HC
3	Polygon	5	18860508	18860311	5	18860508	US,US_graph,H01760	0.40878	0.00393	5
9	Polygon	3	19501117	19490825	1,5	19501117	US,US_graph,H07877	0.308525	0.002584	5
23	Polygon	3	19501117	19490919	1,5	19501117	US,US_graph,H07876	1.215863	0.007029	5
17	Polygon	3	19501130	19501109	1	19501130	US,US_graph,H07905	0.026467	0.000033	4
19	Polygon	3	19501130	19501109	1	19501130	US,US_graph,H07905	0.068765	0.000114	4
22	Polygon	3	19501130	19501109	1	19501130	US,US_graph,H07905	0.346745	0.001926	4

Note: Use the highest value for the HC (worst case scenario) if there are multiple techniques to obtain soundings (TECSOU).

Table 14.2 S-57 TECSOU codes (definitions from IHO S-32).

Code	Technology	Definition
1	Found by Echo-sounder	Depth was determined by using an instrument that determines depth of water by measuring the time interval between emission of a sonic or ultrasonic signal and return of its echo from the bottom.
2	Found by Side-scan-sonar	Depth was computed from a record produced by active sonar in which fixed acoustic beams are directed into the water perpendicularly to the direction of travel to scan the bottom and generate a record of the bottom configuration.
3	Found by Multi-beam	Depth was determined by using a wide swath echo sounder that uses multiple beams to measure depths directly below and transverse to the ship's track.
4	Found by Diver	Depth was determined by a person skilled in the practice of diving.
5	Found by Lead-line	Depth was determined by using a line, graduated with attached marks and fastened to a sounding lead.
6	Found by Wire-drag	A given area was determined to be free from navigational dangers to a certain depth by towing a buoyed wire at the desired depth by two launches, or a least depth was identified using the same technique.
7	Found by Laser	Depth was determined by using an instrument that measures distance by emitting timed pulses of laser light and measuring the time between emission and reception of the reflected pulses.
8	Found by Vertical acoustic system	A given area has been swept using a system comprised of multiple echo sounder transducers attached to booms deployed from the survey vessel.
9	Electromagnetic sensor	Depth was determined by using an instrument that compares electromagnetic signals.
10	Photogrammetry	Depth was determined by applying mathematical techniques to photographs.
11	Satellite imagery	Depth was determined by using instruments placed aboard an artificial satellite.
12	Found by leveling	Depth was determined by using levelling techniques to find the elevation of the point relative to a datum.
13	Swept by side-scan-sonar	A given area was determined to be free from navigational dangers to a certain depth by towing a side-scan-sonar
14	Computer generated	Sounding was determined from a bottom model constructed using a computer.

In the Editor Toolbar, click **EDITOR > STOP EDITING**.

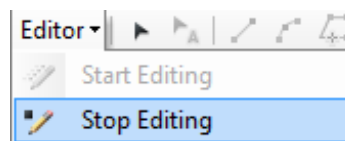

When prompted to save, click **YES**.

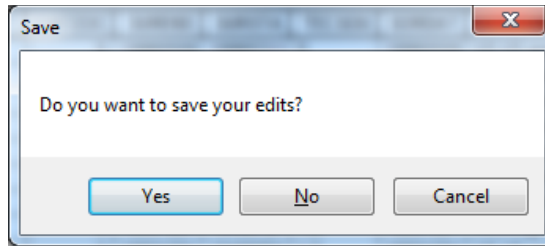

14.6.3 Convert vector file HC Polygons to an HC raster

Open the **Polygon to Raster (Conversion) Tool**.

In the toolbox, click *Conversion Tools > To Raster > Polygon to Raster*.

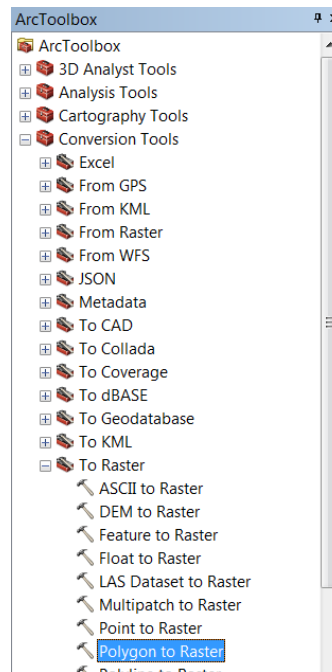

In the Polygon to Raster window, choose: **HC_polygons** as the Input Features, , **HC** as the Value Field, and Cellsize: **30**. Press **OK**.

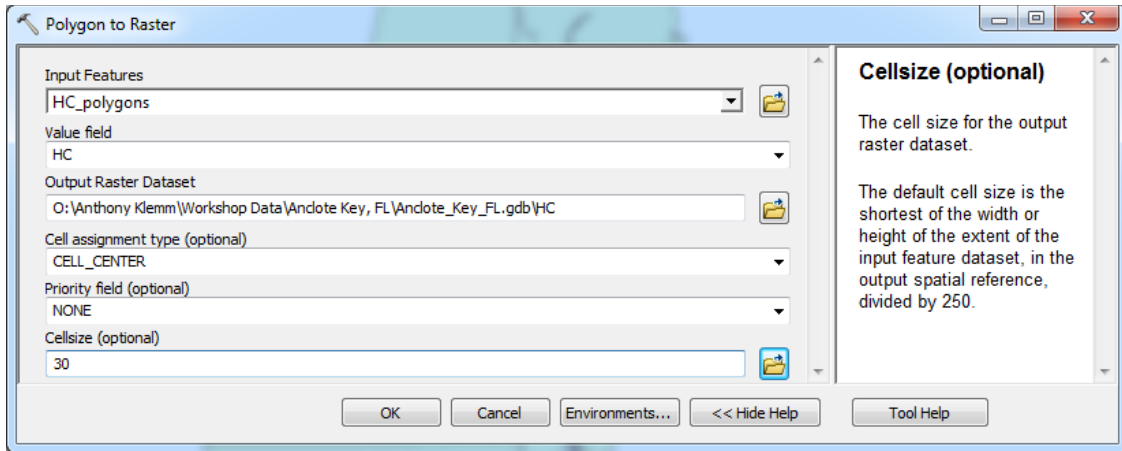

The resulting layer is a thematic map of the Hydrographic Characteristics.

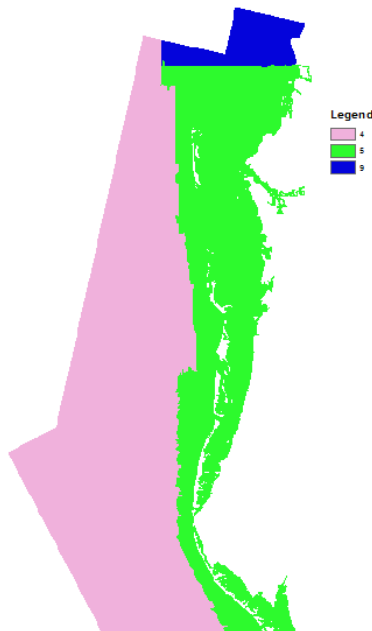

Save the project by selecting **File/Save** in the main menu.

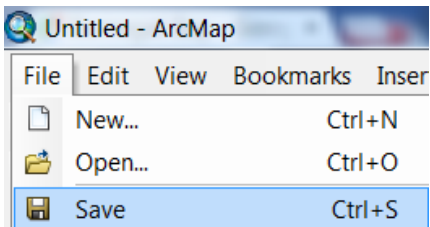

14.7 Chart Adequacy

14.7.1 Archiving the layers

Select **Union** toolbox, in **Analysis Tools/Overlay**.

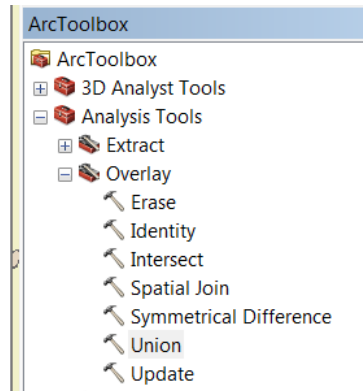

In the **Union** window, load the feature files of the bathymetric difference (i.e., merge), vessel traffic (VT_poly), and Hydrographic Characteristics (HC_polygons) feature files. Save the output feature class as *Adequacy_table* and press **OK**.

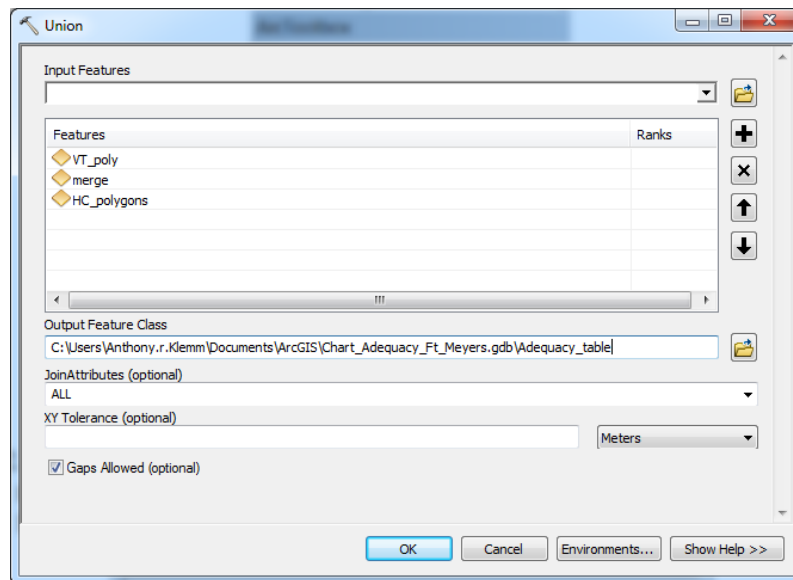

Right-click the *Adequacy_table* layer and select **Open Attribute Table**.

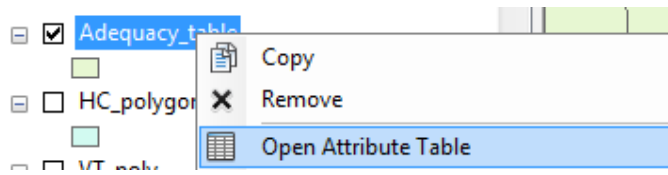

Open the **Table Options** in the **Table** window and select **Add Field...**

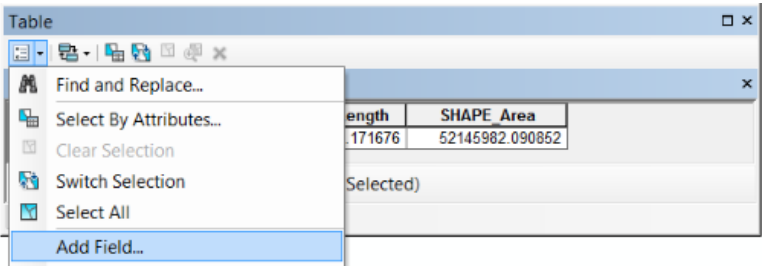

In the Add Field window, type **Name: Chart_Number**, make sure that **Type: Text (length: 20)** and press **OK**.

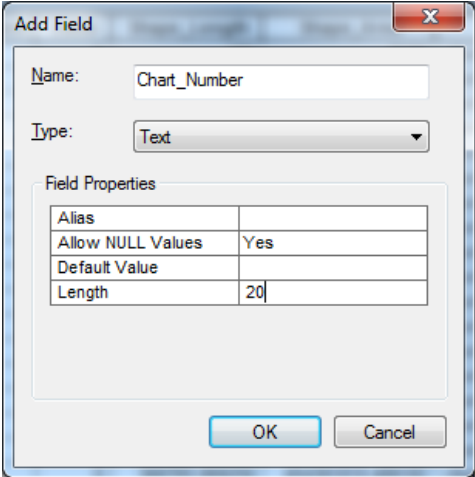

A new field was added to the Table. Drag the fields (left-click on the header of the field) and organize the table as follows.

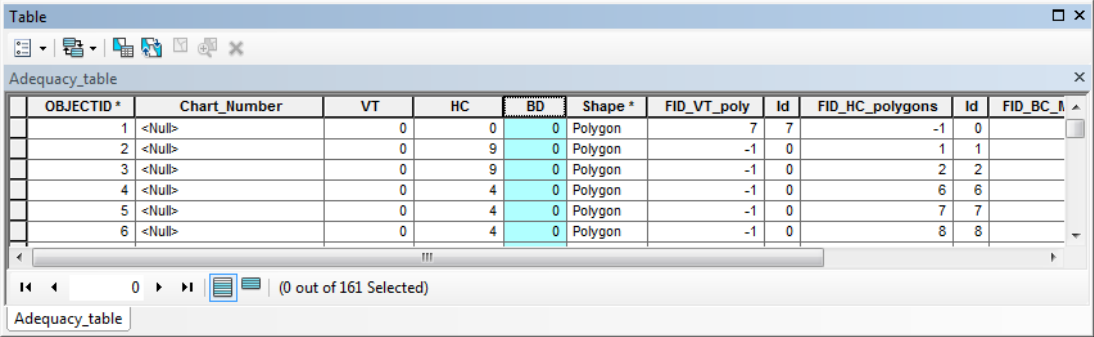

Right-click on the **Chart_Number** field and select **Field Calculator...**

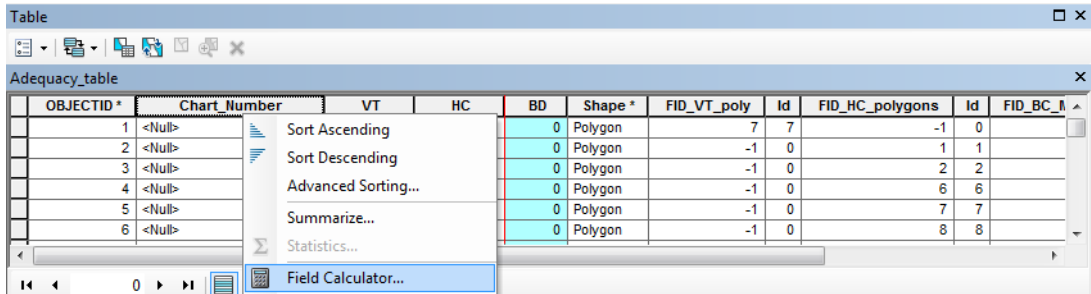

The screenshot shows a table window titled 'Table' with a sub-window 'Adequacy_table'. The table has columns: OBJECTID, Chart_Number, VT, HC, BD, Shape, FID_VT_poly, Id, FID_HC_polygons, Id, and FID_BC. A context menu is open over the 'Chart_Number' column, with 'Field Calculator...' selected. The table data is as follows:

OBJECTID	Chart_Number	VT	HC	BD	Shape	FID_VT_poly	Id	FID_HC_polygons	Id	FID_BC
1	<Null>			0	Polygon	7	7	-1	0	
2	<Null>			0	Polygon	-1	0	1	1	
3	<Null>			0	Polygon	-1	0	2	2	
4	<Null>			0	Polygon	-1	0	6	6	
5	<Null>			0	Polygon	-1	0	7	7	
6	<Null>			0	Polygon	-1	0	8	8	

In the **Field Calculator** window, type in the chart number under “*Chart_Number* = “ and press **OK**.

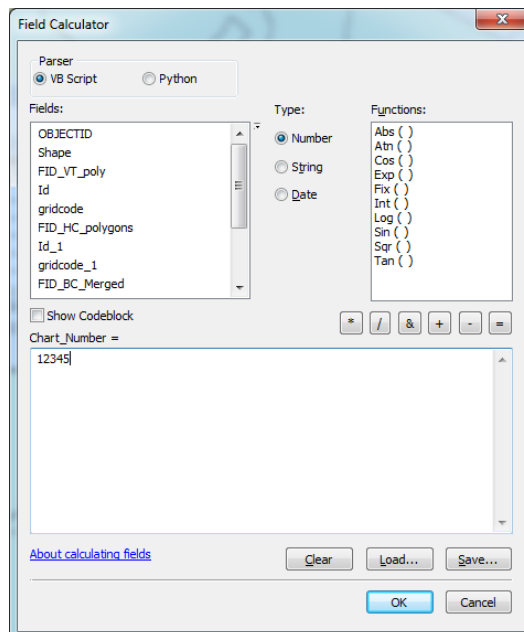
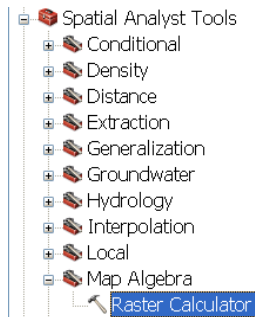

Table is now ready to be used for inquiry either in ArcMap as a Table or in MS Excel as a spreadsheet by loading the *Adequacy_Table.dbf* file.

14.7.2 Calculating the adequacy

Select **Spatial analyst Tools/Map Algebra/Raster Calculator** in the **Toolbox** window.



In the **Raster Calculator** window, write the following command:
 $("Vessel_Traffic" * ("HC" + "Bath_Difference")) / "Ref_surface1m"$. Save the output raster as **Chart_Adequacy** and press **OK**.

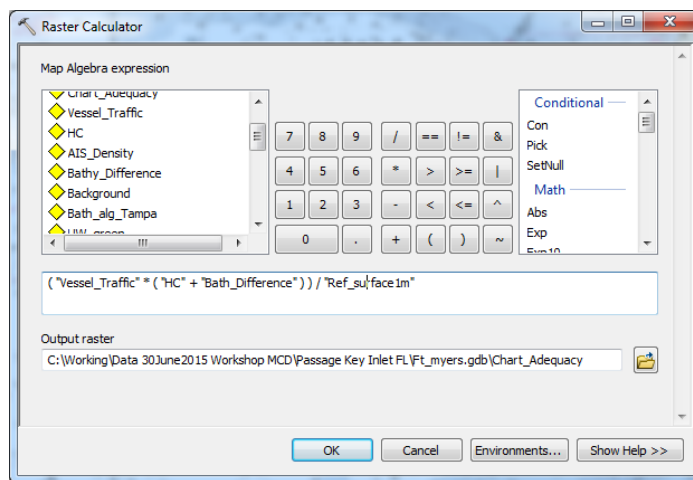

In the **Table of Contents**, right-click on the **Chart_Adequacy** layer and select **Properties...**

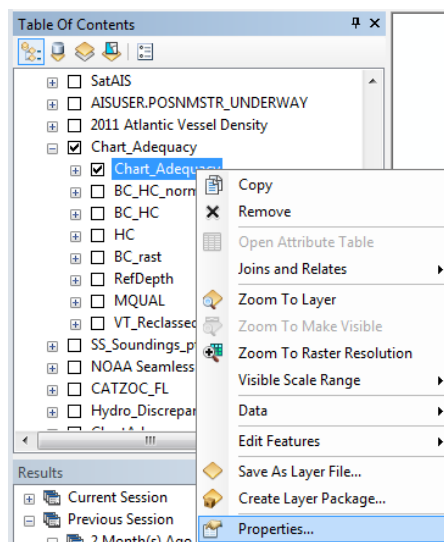

In the **Layers Properties** window, under the **Symbology** tab, select **Show: Classified**, select **“2”** classes and press **Classify...**

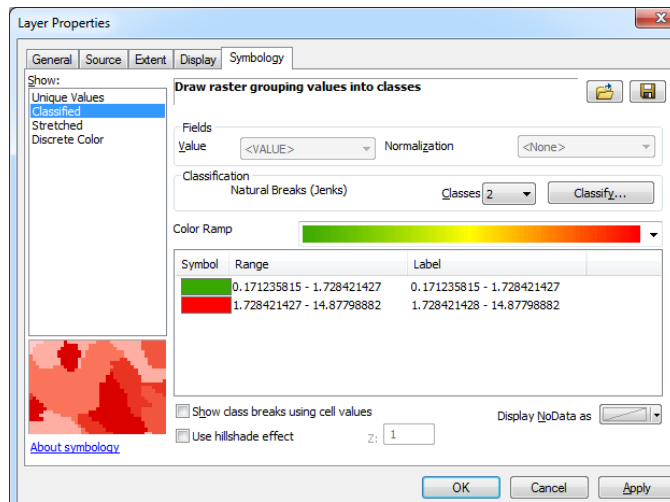

In the **Classification** window, Type the **0.5** and press **OK**.

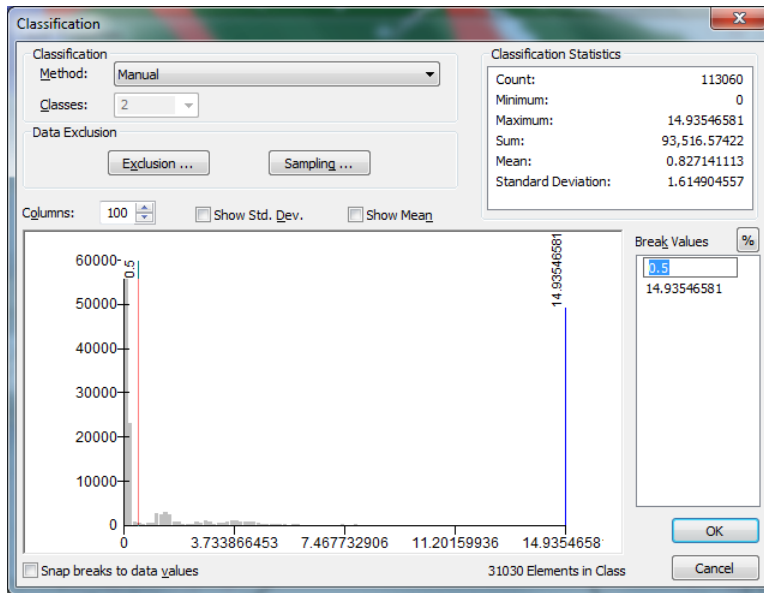

Press **OK** in the **Layer Properties** window.

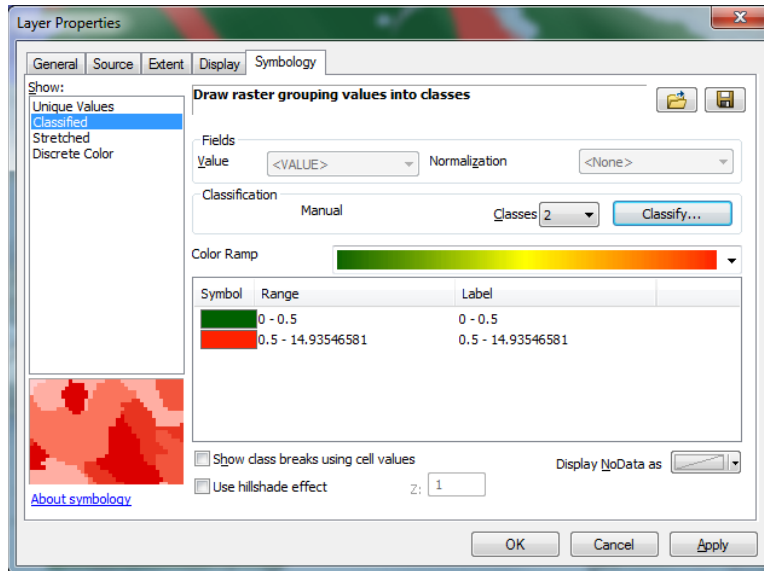

The result is a chart adequacy raster layer classified to adequate (green) and inadequate areas (red).



14.7.3 Estimating the percentage of inadequate areas for navigation

In the **Table of Contents**, right-click on the **Chart_Adequacy** layer and select **Properties...**

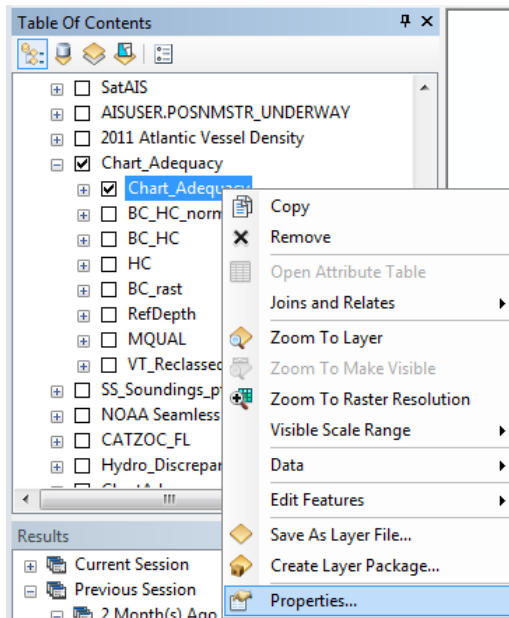

In the **Layers Properties** window, under the **Symbology** tab, select **Show: Classified**, and press **Classify...**

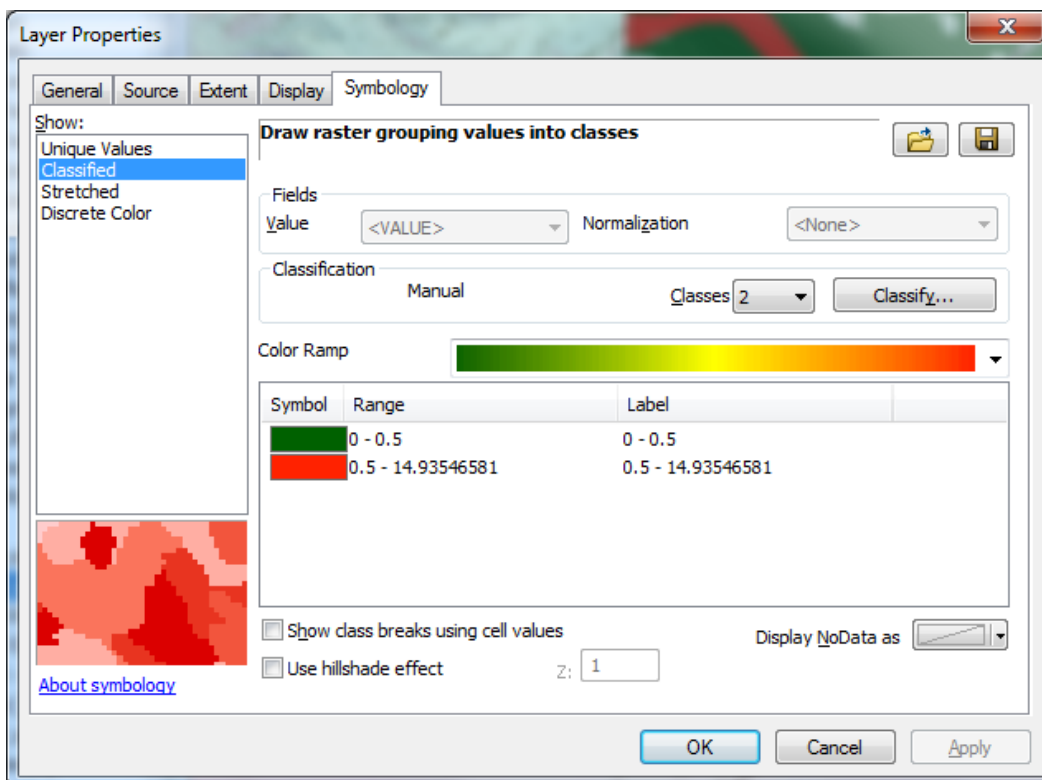

In the **Classification** window, select the higher number in the break value box. Write down the **Count:** under the **Classification Statistics** as the total pixel number representing the charted area and write the number of elements in the class (bottom right if the histogram plot) as the pixel number of inadequate areas.

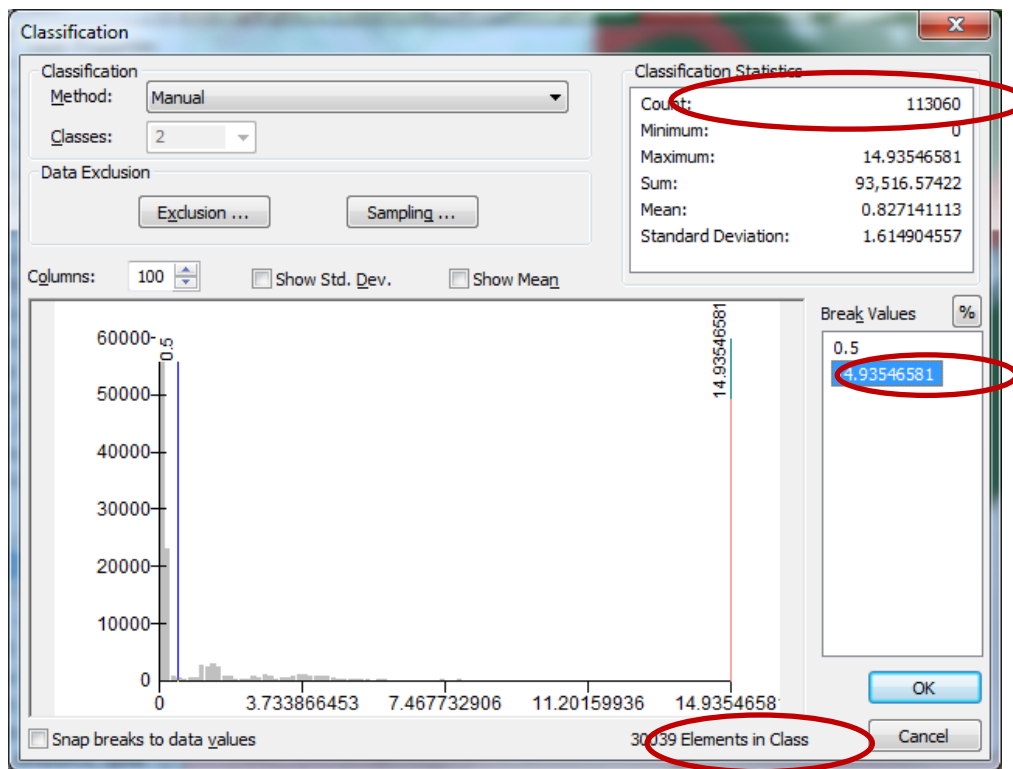

The percentage of inadequate areas for navigation is calculated by following equation:

$$\text{Percentage} = \frac{\text{Pixel number of inadequate areas}}{\text{Total pixel number representing the charted area}} * 100$$

Close all windows.

Save the project by selecting **File/Save** in the main menu.

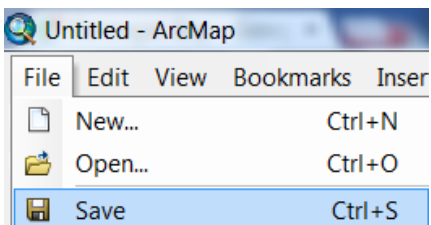

Appendix A – Example for Chart Adequacy Review Template

Site: Ft. Myers, FL, USA		
Compiler: John Doe	Date: 1 November 2015	
Supervisor: Thomas Jefferson	Date: 5 November 2015	
<u>Data Sources</u>		
Raster charts:	11425 11427	
Electronic Charts:	US4FL19M US4FL42M	
Satellite imagery date (sensor):	15 March, 2015 (Landsat 8)	
Dates of AIS data:	July, 2012 to June, 13	
	Number of pixels	Area (Km²) (1 pixel = 0.0009 Km ²)
<u>Total charted area:</u>	113,060	101.75
<u>Adequate for navigation</u>	83,021	74.72
<u>Inadequate for navigation</u>	30,039	27.03
<u>Percentage of adequate area</u>	26%	26%
Schematic overview		
		

Chapter 15.0 Map Digitizer Program Version 2.1.0

Contributed by Chaim Keller, The Chai Tables, Israel, and John K. Hall, Geological Survey of Israel (Retired), Israel

This software is freeware. Use it and pass it along.

TableWorks is a licensed component of GTCO CalComp Corporation which allows it to be incorporated into the installation programs that use their table digitizers.

This program is still in its developmental stage. Please report any bugs to the author, Chaim Keller, at: chaimkeller@yahoo.com

The latest version of this program will be maintained at the following address:
http://www.chaitables.com/MapDigitizer_setup.exe

Introduction

This program was originally conceived as a replacement for a map digitizing program that was written many years ago by Dr. John K. Hall to run on DOS using Halo graphics and employing a GTCO digitizer with a 16 button mouse. That program was remarkable for its capability to digitize a great deal of points in a short amount of time. To bring the software up to date, Dr. John K. Hall (jkh1@012.net.il) kindly offered to support the writing of its replacement which can run equally well with or without a GTCO digitizer. However, during the course of the program development, I drifted from the original idea since it was my feeling that much more could be accomplished by writing a user-friendly Windows based interface that incorporated digitizing as well as other features of John Hall's original suite of DOS programs such as rubber sheeting (working on a grid of the graticule intersections so as to correct for imperfections in printing, scanning, etc.) and DTM creation using Hardy Quadratic Surfaces, all in one package.

Program Instructions

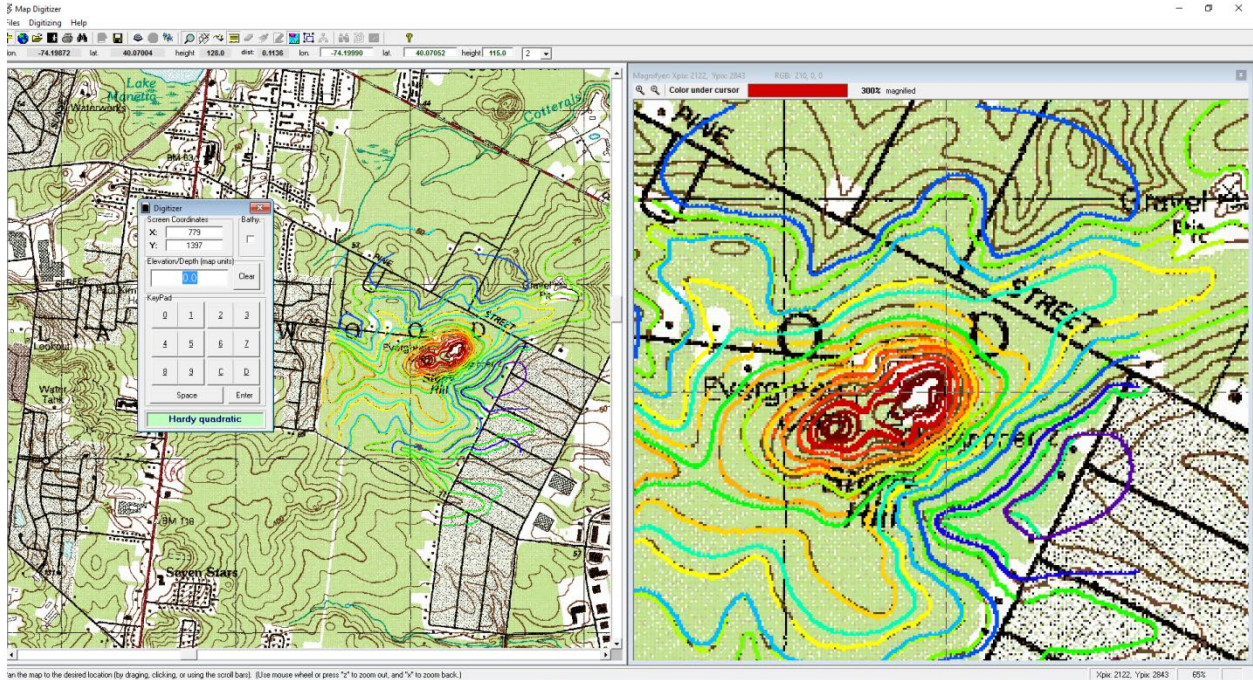

Picture: Program in the process of creating Hardy Quadratic Surfaces.



Picture: Toolbars and coordinate text boxes.























Buttons (left to right):

- 1: **Options** menu, 2: **Maps**, 3: **Open** stored contour file (topo_pixel.xyz), 4: **Goto** coordinates entered in the coordinate text boxes, 5: **Print** map, 6: **Search** for digitized points, 7: **Report** listing the digitized points, 8: **Backup** results as dxf file, 9: **Enable** GTCO CalComp Tablet Digitizer interface, 10: **Google** Earth interface (not supported in this version), 11: **GPS** interface, 12: **Magnifier** window (right panel in uppermost picture), 13: **Digitize**, 14: **Extend** grid lines, 15: **Rubber** Sheeting, 16: **Eraser**, 17: **Sweep** eraser, 18: **Edit** digitized points, 19: **Hardy** Quadratic Surfaces, 20: **Create** DTM, 21: **Smooth** merge areas, 22: **Search** for highest points, 23: **Contours**, 24: **Profiles**, 25: **Help**

15.1 Toolbar

(buttons, left to right, see picture above)

1. **Options.** Add maps, change opening map to one of those in a list, define boundaries, change settings for program features.

-
2.  **Map:** Open the map defined in “Options” to be the default.
 3.  **Open:** Open saved topo_pixel.xyz format file for replotting as contours.
 4.  **Goto:** Go to the coordinates entered in the coordinate text boxes
 5.  **Print:** Print a screen shot of the map
 6.  **Search:** Search for digitized points.
 7.  **Report:** Display search results.
 8.  **Save:** Save the digitized data.
 9.  **Tablet:** Enable GTCO CalComp Tablet interfacing.
 10.  **Google Earth:** Plot digitized points on Google Earth (not supported in this version).
 11.  **GPS:** Use a GPS device connected to a USB port on your computer to locate your position on the displayed map (requires a geographic latitude and longitude coordinate system).
 12.  **Magnify:** Open magnify window.
 13.  **Digitize:** Plot previously digitized points and open digitizer dialog
 14.  **Extend:** Extend partially missing or hidden grid lines.
 15.  **Rubber Sheeting:** Run the “Rubber Sheeting” Wizard.
 16.  **Eraser:** Click to erase errant contour points (continually press the left mouse button while erasing.)
 17.  **Sweep:** Define rectangular region to erase all the digitized points.
 18.  **Edit:** Edit digitized points, i.e., delete (“K”), or move (“R”).
 19.  **Hardy:** Drag the mouse to define a rectangular region for calculating Hardy quadratic surfaces. You must have rubber sheeting activated, as well as having digitized the selected region.
 20.  **Merge:** Drag the mouse within a region whose elevations have been determined by the Hardy Quadratic Surfaces calculations. You can choose to create DTM patches from the Hardy quadratic surface results and merge them onto the base DTM. DTM spacing and units are set in the Options dialog “DTM” tag. You must also define the path to a folder where the created DTM’s will be stored (use the “Path” tab in the Options dialog.) You can also use the Hardy Quadratic Surfaces to repair the elevation model that is being used. When finished merging the desired regions, depress the button, and then continue calculating Hardy Quadratic Surfaces for other digitized regions (see above). Then repress the merge button. The merged regions already completed are outlined by boxes. Proceed to select a new region to merge, etc.
 21.  **Smooth DTM:** Drag the mouse over the borders between merged regions in order to smooth the transition between them using a spline fit. This button is only activated when merging (see above).
 22.  **Search for highest point:** Drag the mouse to select a region to search for the highest elevation. This button is already activated when an elevation model has been defined (use the “Paths” tab in the Options dialog) or has been created by merging Hardy Quadratic surfaces. Note that if you click on any point in the map, the distance from that point in kilometers will be displayed for geographic (e.g., WGS84) and ITM (Israel Transverse Mercator) DEMs or when using the base DTM as a height model.
 23.  **Contours:** Drag the mouse to select a region for plotting colored elevation contours. This button is only activated if a path to an elevation model has been defined (use the “Paths” tab in the Options dialog), or after creating a DTM elevation model by merging output from the Hardy Quadratic surface calculations. To use the latter, you must check the appropriate checkbox in the “DTM” tab of the Options dialog.

-
24.  **Profiles:** Click on a point and then select which horizon to profile. After the calculation is completed, an interactive graph of view angle versus azimuth of either the eastern or western horizon for any clicked point is displayed. To use this option, the map must be defined as having either ITM or geographic (latitude, longitude) coordinates. You must also enable the saving of xyz coordinate files (i.e., 'topo_coord.xyz' files) (Use the "Settings" tab of the Options dialog).

This program has a GPS interface. Press the "GPS" button, and set the Baud rate and COM port of a NMEA 0183 v3 compatible USB dongle (see picture below). Once the settings are accepted, the map moves to the GPS location. This option requires that the map has been gridded to a geographic latitude and longitude grid.

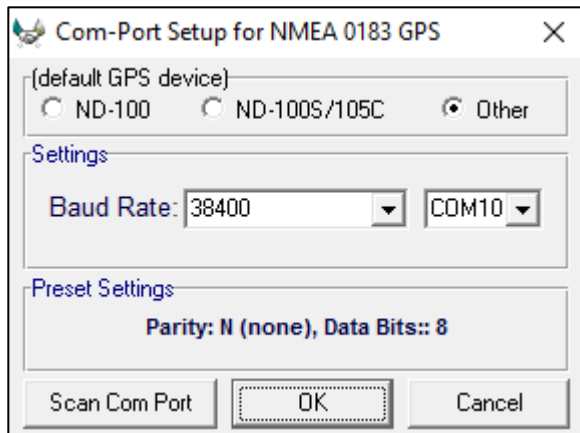



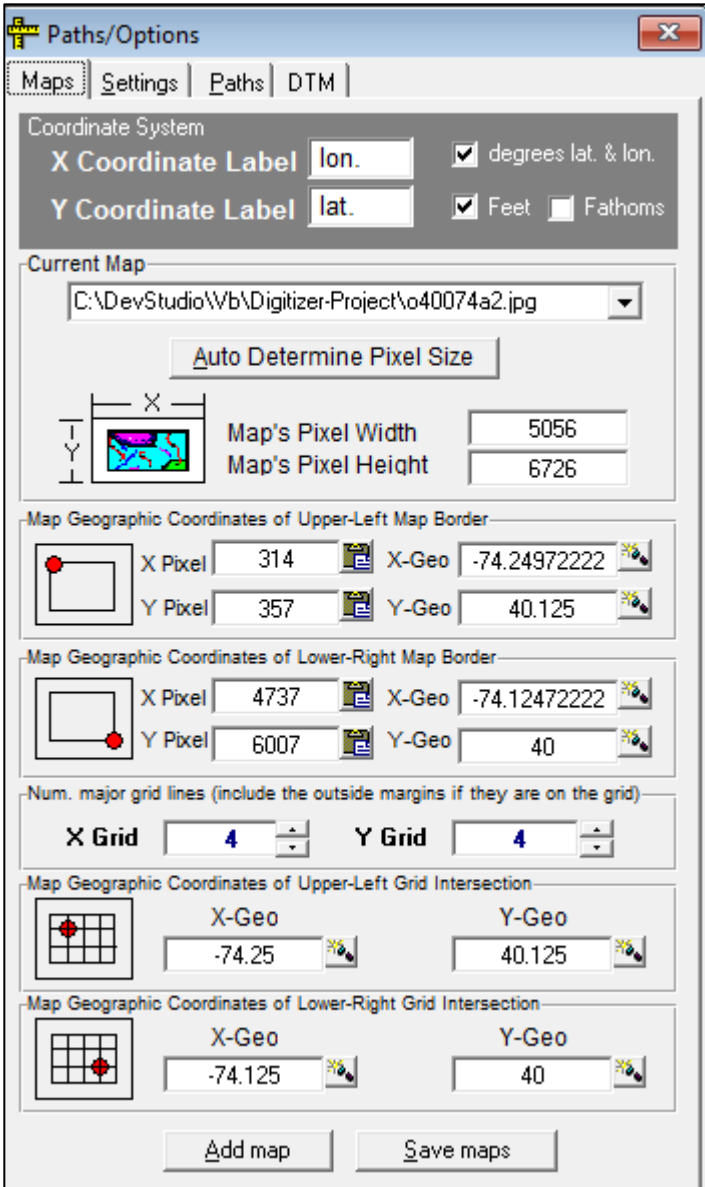

15.2 Map Parameters

(Options dialog: "Maps" tab)

1. Load a map by using the "Options" button (first button on the toolbar).  This program supports most types of images with the notable exception of "tif" files (there is no native VB6 support). If you want to use a tif file, then you will need to convert it to another format.)



2. If you know your map boundaries, then add them into the appropriate text boxes. If not, after saving the new map, click on the "Map" button, , (the second button on the toolbar) and use the mouse (and the magnifier window -- activate it by clicking on the magnifier button ) to determine the screen coordinates.
3. In order to use all features of this program, you must define the coordinate system of the map and input the appropriate the grid boundaries into the text boxes in the Option menu. The simplest coordinate scheme uses the screen coordinates of the map's four corners and the corresponding geographic coordinates. To use this method, enter the above coordinates and click on the "Rubber Sheeting Button", , on the toolbar and choose "Simple method".
4. A much more accurate coordinate system can be defined by using the grid intersection coordinates through affine transformations and rubber sheeting based on the routines of Doythser and Hall (Computers &

Geosciences, 23(7), pp. 785-791, 1997). To use this method, you will need to digitize the grid intersection by using the Rubber Sheeting Wizard (click on the "Rubber Sheeting" button on the toolbar, ). See below for further discussion of this topic.

5. Map navigation and zooming can be accomplished by
 - Using the scroll bars
 - Clicking on the desired position to center.
 - Dragging the map
 - Zoom in and out with the wheel mouse, or use the quick keys "z" and "x".
 - (This program fully supports a touch screen interface, so use the appropriate finger gestures to move and zoom).
 - Arrow keys
 - Home key (moves map to top left corner)
 - End key (moves map to bottom right corner)
 - PgUp key (moves map to top of map)
 - PgDn key (moves map to bottom of map)

15.3 Program Settings Analysis Parameters

(Options dialog "Settings" tab)

1. Distance between points on a digitized contour: only generate points with this pixel interval when digitizing contours. (Larger for more points, smaller for less points.)
2. Distance between points on a digitized line: Ditto for digitizing lines.
3. Starting Euclidean color sensitivity: initial Euclidean threshold for a contour color. Decrease the sensitivity to increase the acceptance threshold and promote longer contouring without a break.
4. Starting contour interval: Steps in meters when drawing contours.
5. Hover distance in Pixels to search for digitized points: Used in "Edit" mode. The larger the number, the farther the program searches around the current mouse position for a digitized point. (Larger numbers require more CPU.)
6. Erasing mode brush size. Increases or decreases the area the eraser will erase in "Eraser" mode.
7. Write output of Hardy Quadratic Surfaces and contouring to xyz output files checkbox. This option must be checked in order to enable horizon profiles.
8. Contouring method: pick either 4 or 8 directional Freeman chain methods.
9. Centering screen while digitizing points checkbox: If checked, the program won't center the map on the left mouse click. This allows a region of the screen to remain fixed until the point digitizing is finished.
10. Warning checkboxes: If checked, program won't give messages about missing paths or auto redraw errors.

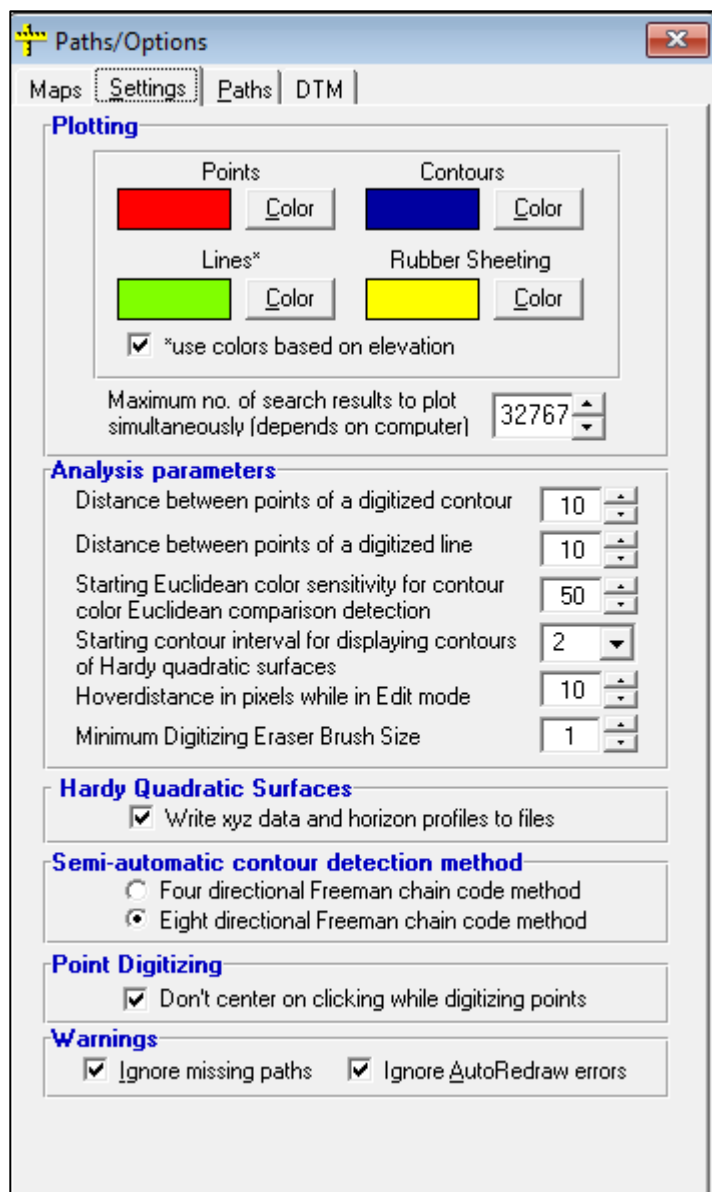

15.4 Program Paths

(Options dialog: “Paths” tab)

1. Path to ASTER DEM tiles (“bil” format).
2. Path to 1 arc sec SRTM tiles (“hgt” format).
3. Radio buttons to choose the elevation model to be used for elevations in the program when there is no created DTM available.
4. Path to folder that will contain DTM models created by this program.
5. Path to Google Earth’s exe file (not yet supported in this program version).
6. Path to directory to write “kml” files (not yet supported in this program version).
7. Path to Google Earth icon files (not yet supported in this program version).

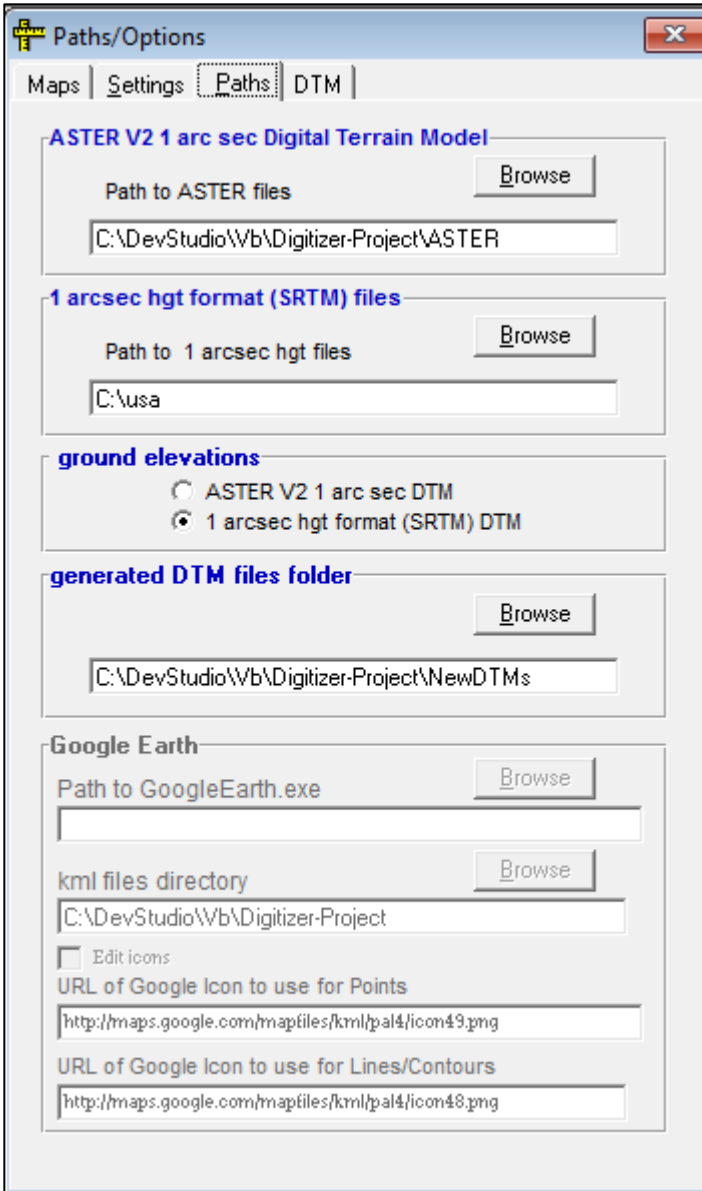

15.5 DTM Settings

(Options dialog: “DTM” tab)

1. Grid size for creating DTM files in either ITM or UTM coordinates.
2. Grid size for creating DTM files in geographic latitude and longitude degrees.
3. Elevation units for created DTMs. Default is meters (doesn't need to be chosen). If a custom unit is chosen, the custom conversion factor from meters needs to be entered into the text box. For example, if creating a DTM in centimeters, enter “100”.
4. Azimuth range for view angle versus azimuth profiles. For example, if “45” is entered, the profiles will be calculated from -45 degrees to +45 degrees around due East or due West.
5. Spacing in azimuth to calculate in the profile. E.g., “0.1” mean steps of 0.1 degrees.

6. Distance in kilometers east or west of the chosen point to start using elevation points for calculating the profile. This parameter removes close obstructions from the view.
7. Choose the elevation model precision. Lower precision saves memory.
8. Check box: use the created DTM elevations for the program elevation display, etc.

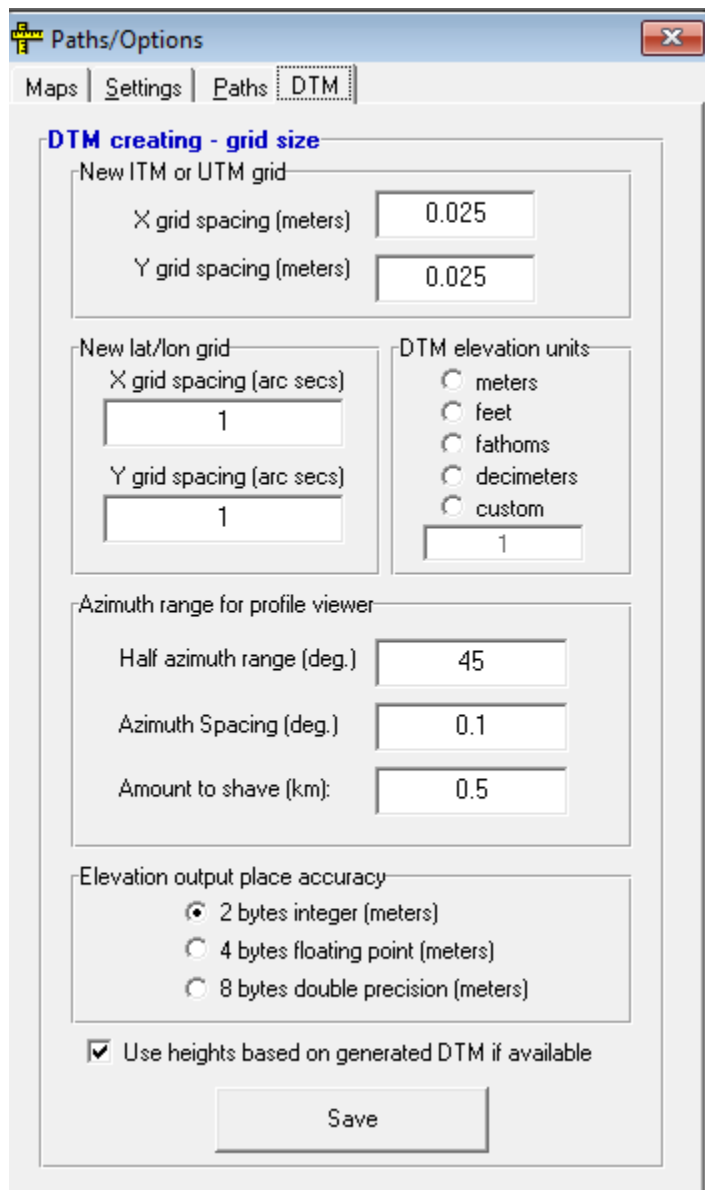

15.6 Digitizing with a Mouse

To begin actual digitizing with a mouse, right click on the map with the mouse or press the "Digitizer" button, , on the toolbar. A digitizer dialog appears (see picture below). Different options can be scrolled by using the SPACE key, or reached more directly by using the shortcut keys (see below). Press ENTER to activate the currently chosen digitizing method (displayed on the bottom on the Digitizer Dialog). Press ENTER again to deactivate that

method. Press SPACE to scroll to a different option, etc., or move to an option directly by using the shortcut keys listed below. **When digitizing below sea level areas in a map**, instead of entering minus signs just click on the “Bathy” check box. You can then enter the depths without the negative sign, and all the elevations will be recorded as depths below sea level.

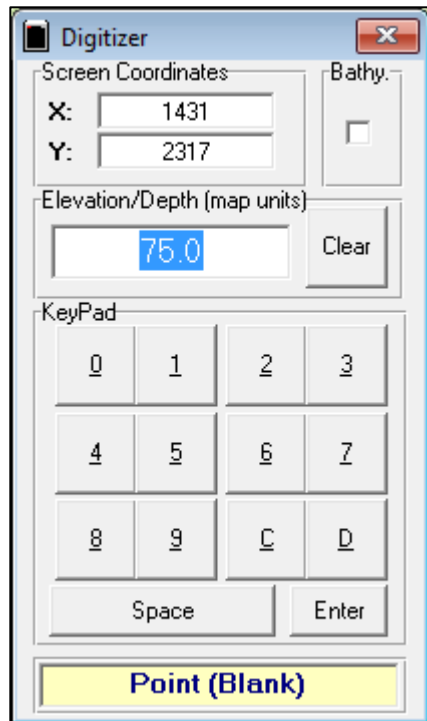

SHORTCUT KEYS:

- **B**: backup to dxf file
- **C**: contour digitizing.
- **D**: (D once) delete last point
- **DD**: (D twice) delete last line
- **DDD**: (D three times) Erasing errant parts of digitized contours.
- **DDDD**: (D four times) Sweep erasing, i.e., erase all digitized points within a rectangular region.
- **H**: Pick rectangular region to draw contours of the already digitized points using the method of Hardy, R., "Multiquadric Equations of Topography and Other Irregular Surfaces, J. Geophysical Research, 76(8), pp. 1905-1915, 1971.
- **L**: Line digitizing
- **P**: (P once) Point digitizing starting with blank elevation.
- **PP**: (P twice) Point digitizing starting with the last inputted elevation.
- **S**: (S once) Sweep erasing, i.e., erase all digitized points within a rectangular region.
- **E**: Edit mode (used for point editing of contours, points, and lines that were already digitized. This mode highlights the digitized points and vertices of lines and contours when hovering over them with the mouse.
- **R**: Replace mode (first need to press “E”, see above). Replace last highlighted point or vertex with a new one at the current position of the cursor.

-
- **K**: Kill mode (first need to press “E”, see above). Deletes the last highlighted point or vertex.

15.6.1 Using the Dialog's Number Pad

They mean what they are except C changes sign, D adds a decimal point. Buttons designed large enough for touch screen. Note, the map can be moved and zoomed with standard touch screen motions.

15.7 Digitizing with the 16 button DrawingBoard VI mouse



(N.B.: You can also use the regular mouse and any of the shortcut keys above at any time.)
Added options are moving in X, Y, Z (zooming). To navigate the map using the digitizer mouse, select one of the above, and then move (zoom) in one direction by pressing the "1" button. Move (zoom) in the opposite direction by pressing the "2" button.

The 16 buttons are mapped to do the following:

Button

- **0** - Use it as a left mouse key for the Digitizer Dialog or anywhere on the map (However, it won't work on any program message dialog box. You will have to use the regular mouse to acknowledge your answer in those cases.)
- **1** - activates the currently chosen digitizing method

-
- **2** - deactivates the currently chosen digitizing method
 - **3** - scrolls through all the navigation and digitizing options.
To activate an option press the "1" key. To deactivate, press the "2" key.
 - **4** - enters the numeral "0" to the elevation text box
 - **5** - enters the numeral "1" to the elevation text box
 - **6** - enters the numeral "2" to the elevation text box
 - **7** - enters the numeral "3" to the elevation text box
 - **8** - enters the numeral "4" to the elevation text box
 - **9** - enters the numeral "5" to the elevation text box
 - **A** - enters the numeral "6" to the elevation text box
 - **B** - enters the numeral "7" to the elevation text box
 - **C** - enters the numeral "8" to the elevation text box
 - **D** - enters the numeral "9" to the elevation text box
 - **E** - changes sign of entered elevation
 - **F** - adds decimal point to end of entered elevation
-

15.8 Digitizing Tools Explanation

1. **Point digitizing:** Used for digitizing trig points and bathymetry depth marks. Enter the elevation/depth and left click on the mouse. To center the mouse on the point, it is advisable to use the magnification window. Click on the magnification button, , magnify the map as desired using the toolbar buttons, and center on the point using the cross hairs.

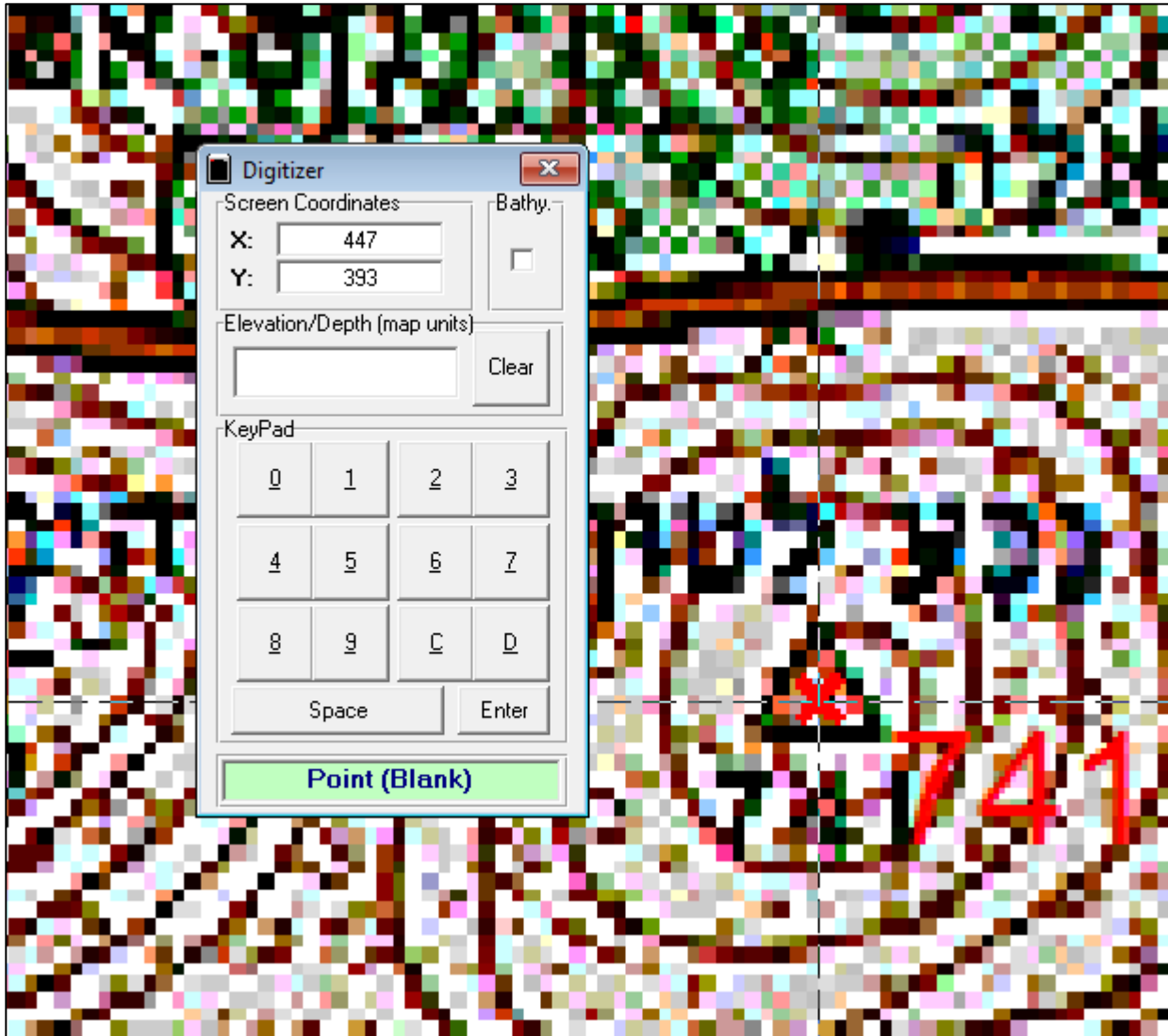

2. **Line digitizing:** Used for digitizing contours. Left click on the starting point. Enter the contour elevation. Move the mouse to the end point; left click to complete the line. Contours are stored in memory as separate points separated by a certain number of pixels as defined in the Options dialog "Setting" tab.



3. **Contour digitizing:** Uses semi-automatic contour boundary detection known as the Freeman chain method (4 directional or 8 directional. See for example Dziech, A., "Contour Extraction and Compression-Selected Topics" [Mobile Robots: Perception & Navigation, Sascah Kolski (Ed.), ISBN: 3-86611-283-1, InTech]. Enter the contour's elevation. Use the magnification window to determine a detection starting point by watching the "Color under cursor" color. Click on the darkest color, and the detection will commence. The color is followed by using RGB Euclidean color comparison criteria. Change the threshold of the comparison by moving the slider on the main program's toolbar. 0 means accept Euclidean RGB differences up to 140. Higher slider values are more selective. End contour detection by pressing the ESC button. If the contour reaches an impassible point, or turns onto itself, you will be prompted to either pick a new starting point or to finish detecting the current contour. The contours are stored in memory as pointed separated by a certain number of pixels defined in the Options "Setting" tab. You can change the detection method from 8 directional (default) to 4 directional in the Option dialog "Setting" tab.

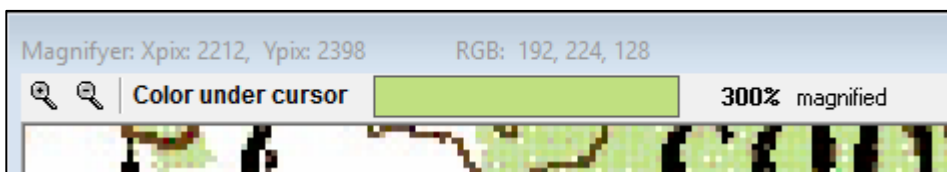

Picture: Contour color display and RGB number to be consulted when determining contour start.

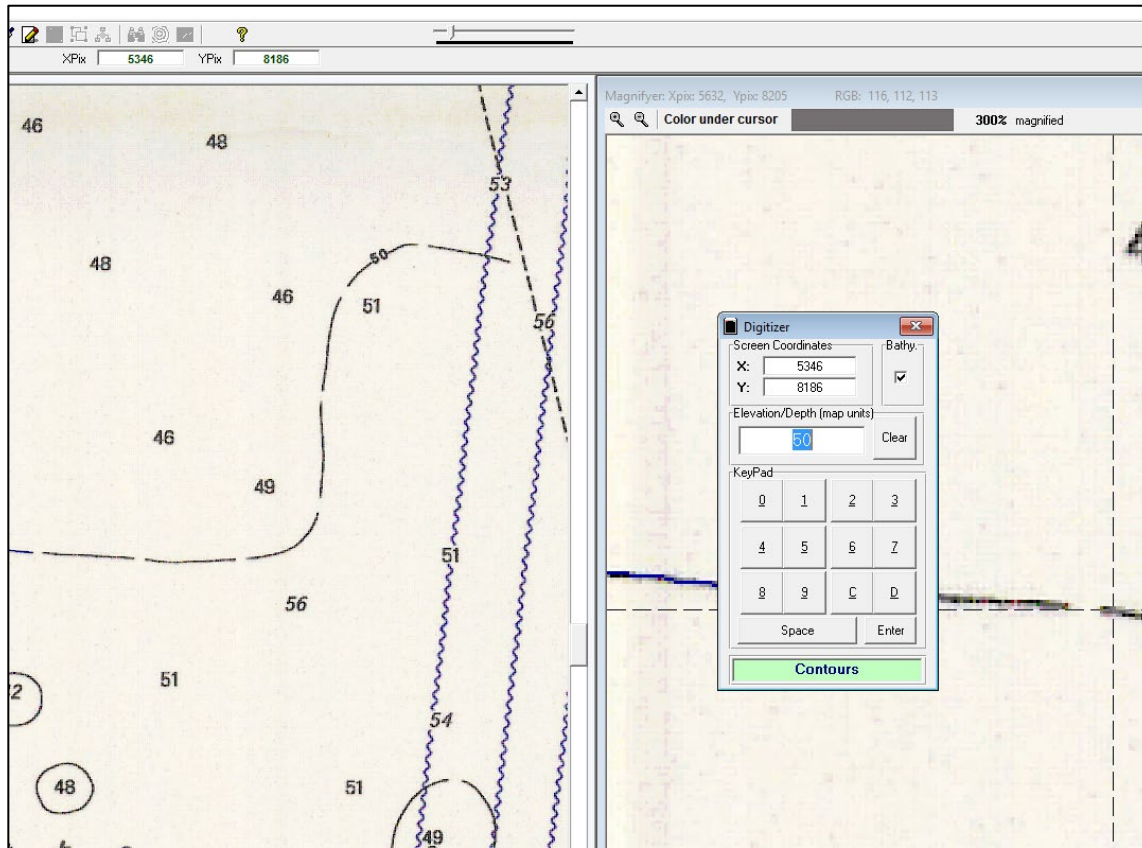

Picture: Contour Digitizing interface. Notice slider bar on toolbar that is used for setting the sensitivity of the color comparison between the starting color (the color clicked on at the beginning of contouring) with colors encountered during the contouring process (the Euclidean difference is used to determine how close the colors match).

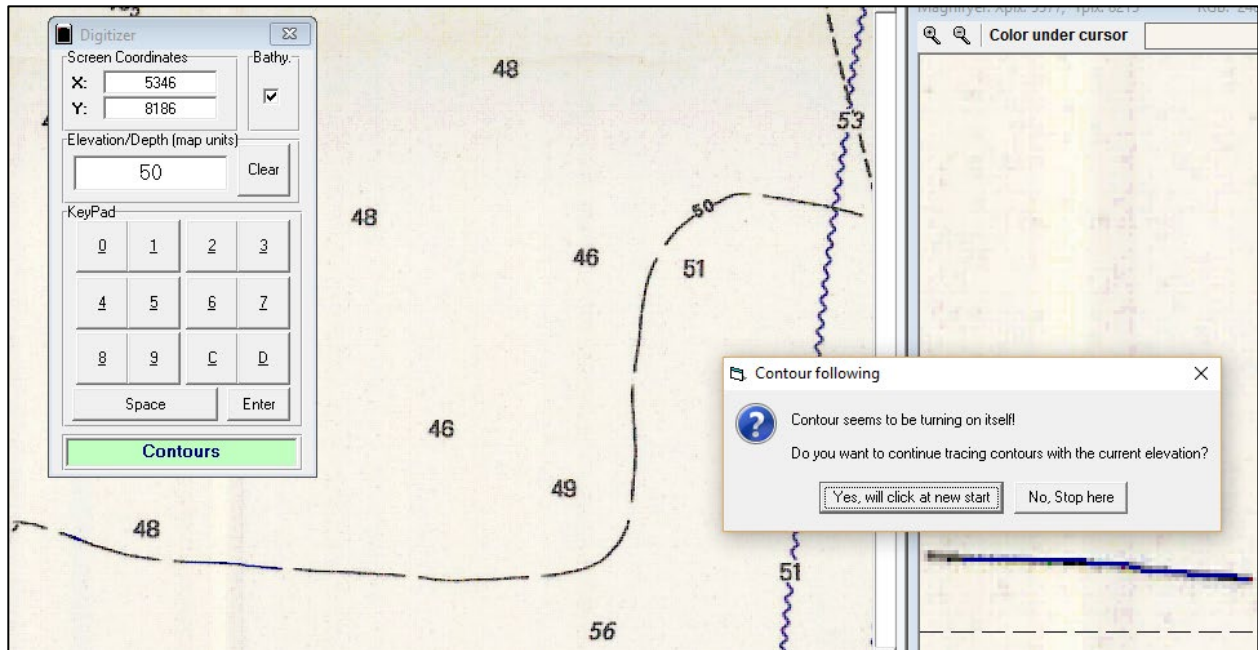

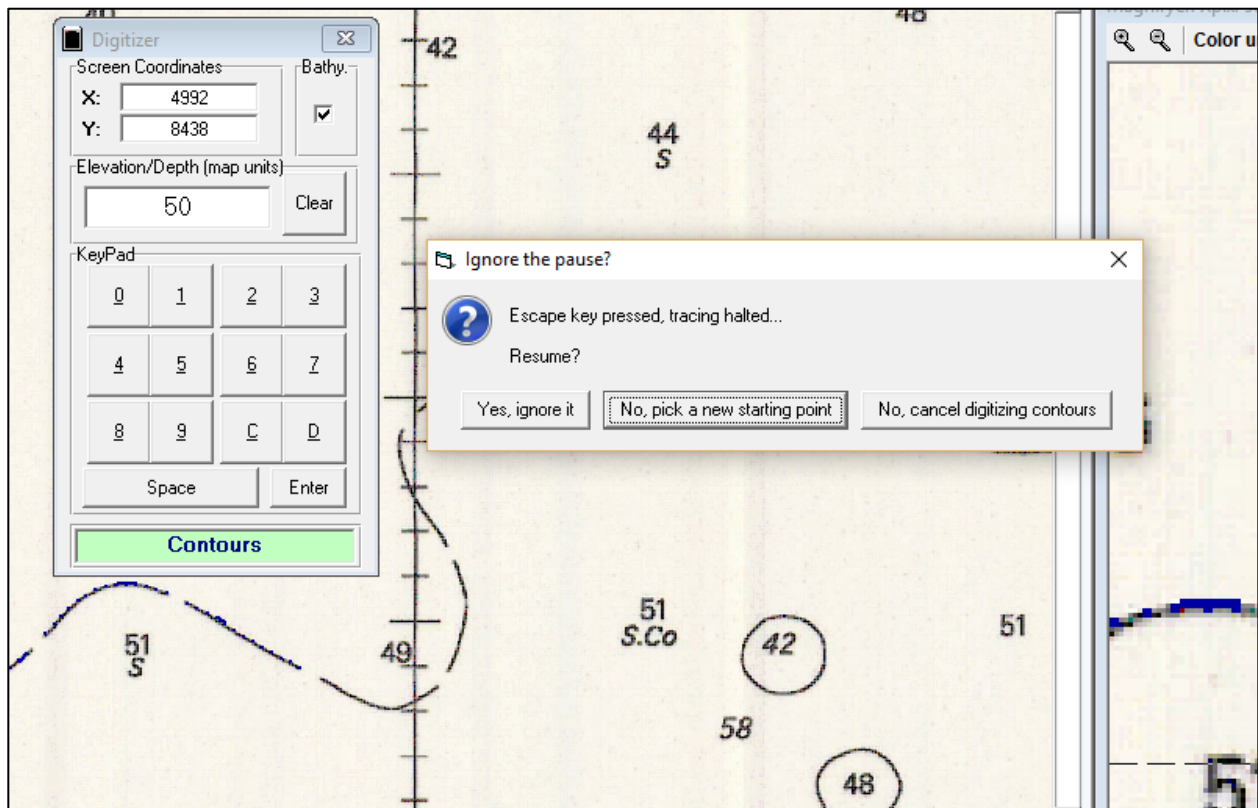

Picture: Contour reaches impasse and program prompts for response





Picture: Contouring was interrupted with the "ESC" button, so program asks for clarification.

-
4. **Eraser:** Erases errant contour points while holding down the left mouse button and passing over those points with the mouse. Does not permanently affect digitized points and lines. Can be activated by entering the short cut keys (see above) when digitizing, or by directly pressing the “Eraser” button on the toolbar, .

 5. **Hardy quadratic surfaces:** . Use it for checking on the quality of the digitizing as well as for calculating the elevations for a DTM elevation model after completing the digitizing of a section of the map. Choose a contour interval in the combo box that appears on the coordinate bar. Drag to define a rectangular region for analysis. Contours are plotted after completion of the calculation. Three temporary files are written during the initial processing. The "topo-out.GSC" file contains a listing of the digitized points within the selected rectangular region (pixel coordinates and height). The ".dxf" file contains the same points with the geographic coordinates. After completion of the analysis, a "topo-out.xyz" file is generated in the typical DEM xyz file format (if this option is checked in the “Settings” tab of the Options menu). A pixel xyz file, topo_pixel.xyz is also generated. Both xyz files can be plotted with such programs like "Global Mapper", or “DTMEditing”.

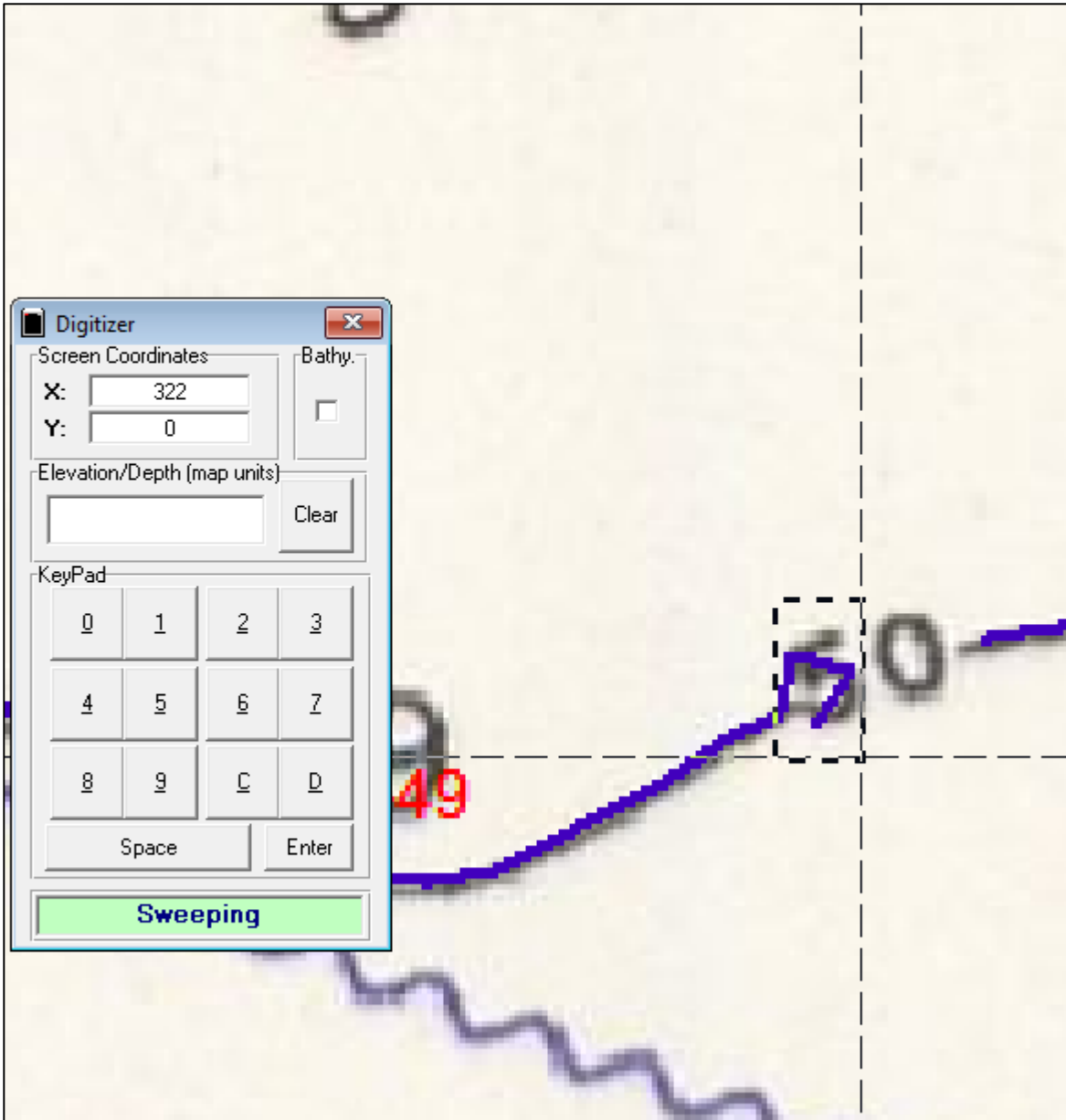
 6. **Sweep erase:** Access it from the Digitizer dialog, or directly from the toolbar, . Define a rectangular region by dragging over the map (see picture below). All digitized points in this region will be deleted whether they were digitized points, lines, or contours. Best tool to be used for fixing errant digitizing as revealed by running a Hardy quadratic surface analysis.



7. **Search:**  . (Can also be accessed from the Digitizer Dialog – see “Short Keys” above). Define rectangular region by dragging over the map to search for any digitized points from point, line, and contour digitizing, as well as contour points that were erased by the Eraser tool. The search results are displayed in the "Report" form. The report form can be used for sorting the points, selecting points according to their elevation, and plotting individual points (right click on the point's listing in the Report form) or plot a group of selected points (use the "Plot" button).

Map Digitizer - [Search Report]

Files Digitizing Help

lon. -74.19717 lat. 40.06735 height 69.0 dist: 0.5097 lon. -74.20009 lat. 40.07135 height 95.0

Select All Unselect All Height filter Plot selected records

Type	Index	X coord	Y coord	lon.	lat.	elevation
Contour point	115	2104	2961	-74.2558928081504	40.0866792094204	22.86
Contour point	116	2102	2956	-74.2558636996314	40.0867229410903	22.86
Contour point	117	2101	2951	-74.2558348510366	40.0867447070707	22.86
Contour point	118	2101	2946	-74.255806262366	40.0867445073618	22.86
Contour point	119	2099	2941	-74.255777153847	40.0867882390316	22.86
Contour point	120	2096	2937	-74.2557477854038	40.0868539363909	22.86
Contour point	121	2094	2931	-74.2557186768849	40.0868976680608	22.86
Contour point	122	2094	2926	-74.2556900882142	40.0868974683518	22.86
Contour point	123	2099	2925	-74.2556627991644	40.0867874401958	22.86
Contour point	124	2104	2925	-74.2556355101146	40.0866774120398	22.86
Contour point	125	2109	2924	-74.2556082210649	40.0865673838838	22.86
Contour point	126	2114	2922	-74.2555809320151	40.0864573557277	22.86
Contour point	127	2118	2919	-74.2555533830411	40.0863692932611	22.86
Contour point	128	2123	2916	-74.2555260939914	40.0862592651051	22.86
Contour point	129	2128	2913	-74.2554988049416	40.0861492369491	22.86
Contour point	130	2132	2910	-74.2554712559676	40.0860611744825	22.86
Contour point	131	2138	2908	-74.255444226842	40.085929180637	22.86

8. **Backup (Save):**  Backups all the digitized points in the entire map to a "dxf" file format

9. **Edit Mode:**  (Can also be activated by the shortcut key while digitizing -- see "Shortcut keys" above). Use this mode for quick editing of digitized points, contours, and lines. When this mode is activated (pressing the "Edit" button, or pressing "E"), the digitized points, etc., are highlighted when hovering over them with the mouse. To move a point to a new position close to the last one, press the "R" keyboard button while the mouse is in the desired new position. To delete a point, press the "K" keyboard button and the highlighted point is deleted. See pictures below. The hover distance can be changed by changing it in the "Settings" tab of the Options dialog (see discussion and picture below).

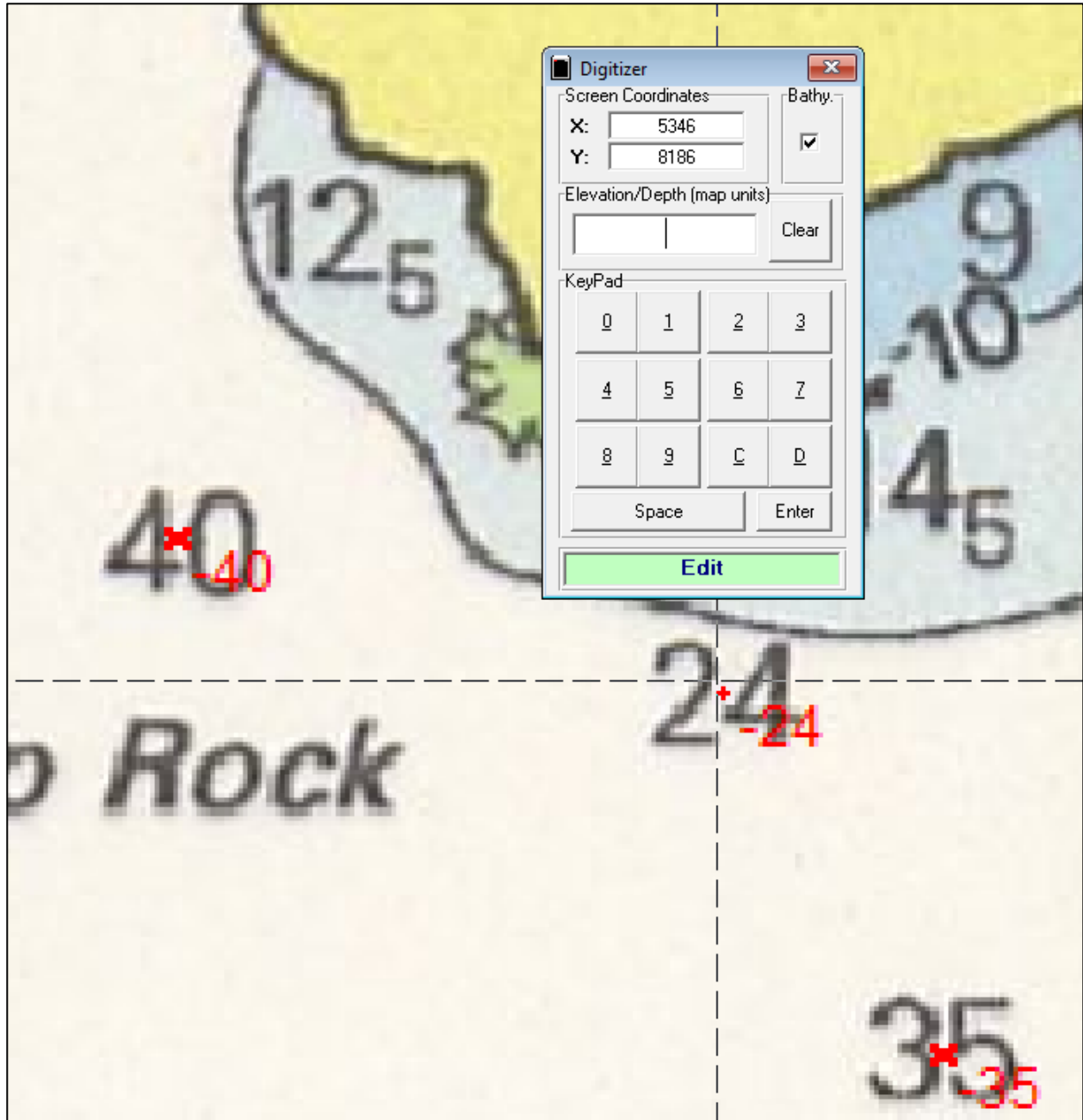

Picture: Editing a digitized point. Notice that the point is highlighted when the cursor is nearby.

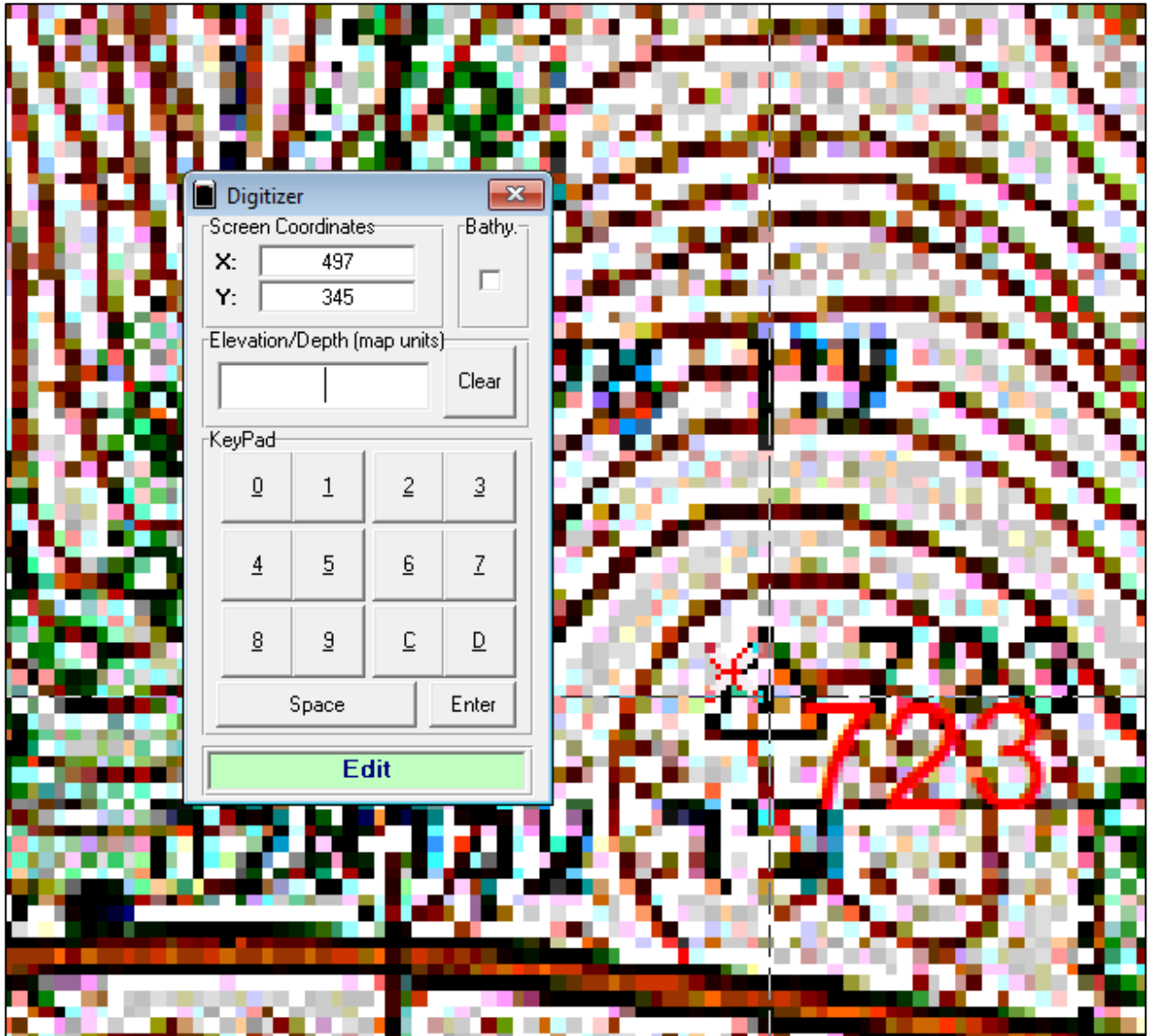

Picture: Point is misplaced (should be in center of trig mark). Cursor is set at correct position and “R” key is pressed to move it to the correct position (see picture below).

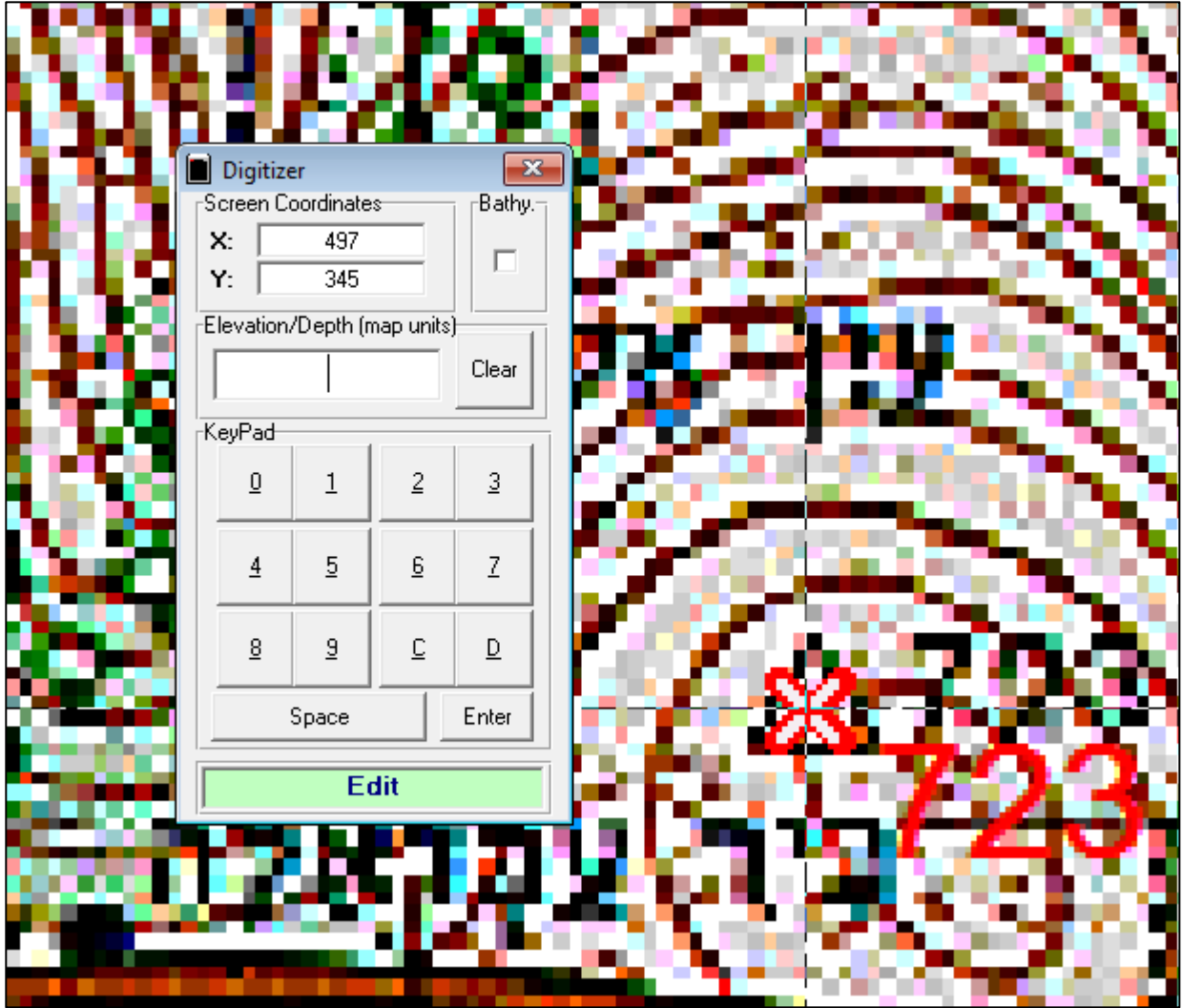





Picture: Digitized point has been successfully edited to be at the center of the trig point.

15.9 Brief Tutorial on creating a DTM model from a topographic map

1. Open the Options dialog by clicking on the first toolbar button . Browse for your topographic map (Note: “.tif” files are not supported, so convert them to a supported format). The program determines the pixel size of the map. You are then required to define a grid. Click on the relevant check boxes concerning whether the grid is in latitude and longitude degrees, and whether the elevations on the map are in feet or fathoms. If you will be using the map corners for the coordinate grid without further rubber sheeting (e.g., the map image is not contorted and the corner coordinates are known) then enter the pixel coordinates of the map’s corner (i.e., where the actual map starts and finishes, and not the corners of the map’s borders). You can use the buttons in the dialog for pasting the clicked pixel coordinates. For maps using geographic grids of degrees latitude and longitude, you can enter either decimal degrees, or enter degrees, minutes, and seconds using a “-“ to separate them, e.g., “-32-42-52” is interpreted by the program to mean -32 degrees, 42 minutes, 52 seconds. Use the buttons next to the relevant text boxes to convert from the “-“ format to decimal degrees and vice versa. If you will be using rubber sheeting, which is necessary for rotated grids

or for contorted map images, enter the number of horizontal and vertical grid intersections and the value of grid coordinates (in whatever unit that is being used by the map) in the relevant boxes.

2. Click the “Paths” tab and define a path is defined to the folder where the new DTM’s will be stored. You only have to define paths to ASTER or SRTM tiles if you want the program to display those elevations when moving the mouse and clicking on the map in the process of creating a DTM. This is extremely useful when attempting to read contour values, etc.
3. Click the “DTM” tab and define the grid spacing of the DTM that will be created. For ITM or UTM grids in units of meters, enter the X, Y spacing in meters in the relevant text boxes. For a geographic latitude and longitude grid in degrees, enter the X, Y spacing in units of arc seconds.
4. Press the “Save” button” In the “Maps” tab of the Options dialog to save the map and its associated parameters. The map is added to a list of previously entered maps. Any of the stored maps can be opened and viewed and worked on by selecting it from the list.
5. Open the map by pressing the “Map” button  (the second button in the toolbar). The first time the map is loaded, the program creates a binary file containing the colors of each pixel. The toolbar is grayed out until the end of this operation. This color map is used for editing the digitized points and contours, i.e., restoring the original map when erasing, or when replacing or removing digitized points.
6. You can now proceed with digitizing the map using the Digitizer dialog (click on the Digitizer button, , on the toolbar). The Digitizer dialog and the map interface were designed for maximum user friendliness for mouse, touch screen, and keyboard operations. The map can be easily panned and magnified by any of the above methods. See above for the brief description of special keys or the interfaces. It is especially useful to activate the magnification screen (click on the “magnifier” button on the toolbar) when digitizing the map. The Digitizer dialog offers a wealth of methods for digitizing including points, lines and contours. Editing can be done easily using erasing, sweeping, and deleting. Note that the Digitizer dialog was specifically designed for touch screens in order to facilitate the entering of elevations using the digit buttons. When contouring, it is essential to use the magnifier screen. When you move the mouse over a contour, the color at the cursor is shown. It is essential to pick the darkest color before clicking to start contouring. Adjust the sensitivity of the color threshold to include or exclude similar colors to be accepted/rejected when determining where the contour goes.
7. The next step is to define the grid used for outputting the created DTM. This is done by clicking on the “Rubber Sheeting” button, . The Rubber Sheeting dialog opens. You can choose several options. If the map is not contorted and the coordinates of the map coordinates are known and have been entered in the Maps tab of the Options dialog, then check “Use corner coordinates”. Other check “Rubber Sheeting”. The idea of the rubber sheeting process is to digitize the intersections of the map’s graticule. If an intersection is missing, it can be extended by grids to form intersections. To do this, press the “Extend” grid button and click on the lines beginning and then once again at its end. Repeat this process to extend more grid lines. Pan to the most North Westerly grid intersection. Left click on that point. If its position is satisfactory, then click on the “Next” button. Iterate this procedure from North West to North East, then one grid row down from East to West, continuing across the row, then one row down from West to East. The wizard will show the geographic coordinates of the next intersection. Continue in this manner until the last grid intersection on the most Southerneastern corner is clicked. Afterwards, click on the “Activate calculation method” button. (Digitizing of the grid can also be down along columns by checking the bottom check box in the “Geo Coord. Step Size” frame.) Once the rubber sheeting digitizing is finished, it doesn’t need to be repeated. Each time you press the Rubber Sheeting buttons, the stored intersections are marked and you are notified that all of them have been already digitized and you are prompted to just press the “Activate” button.
8. Once rubber sheeting is defined, elevation values are shown as the mouse moves along the map if the path to an elevation model has been defined in the “Paths” tab of the Options dialog, or if a DTM has been already created for this map.
9. Actual calculation of DTM elevation points can proceed at this point. Click on the “Hardy” button, , and all the digitized points, lines, and contours are shown. Select a rectangular area to calculate the heights by dragging with the mouse. The number of digitized points you can select is limited by the memory of the computer and by the patience you have to wait for the calculation to finish.

-
10. After the Hardy Quadratic Surface calculation is complete, contours of the calculated heights are drawn on the map. To merge these points into a new DTM, click on the “Create DTM” button, . A prerequisite for this operation is defining the map’s corner coordinates. To do this, open the Options menu and paste in the corner pixel and geographic coordinates as displayed in the text boxes (picture shown above).
11. The program first generates a basis DTM file which at this point is all blank. After completion of the writing of the basis DTM, define a region within the drawn contours for merging into the base DTM. Do so by dragging within the contoured regions. It is often best to avoid the edges since the Hardy calculation can be inaccurate in those places if nothing has been digitized beyond the borders chosen.
12. The program will then calculate the heights of this region on a grid size defined in the “DTM” tab of the Options menu and will merge it onto the base DTM. After completion of this process, a box will be drawn around the boundaries of the merged regions. Continue to merge regions until you have exhausted the contoured area. Depress the “Create DTM” button and select a new region of the map that has been digitized for undergoing the Hardy calculation. Continue this process into the entire region of interest has been converted into a DTM.

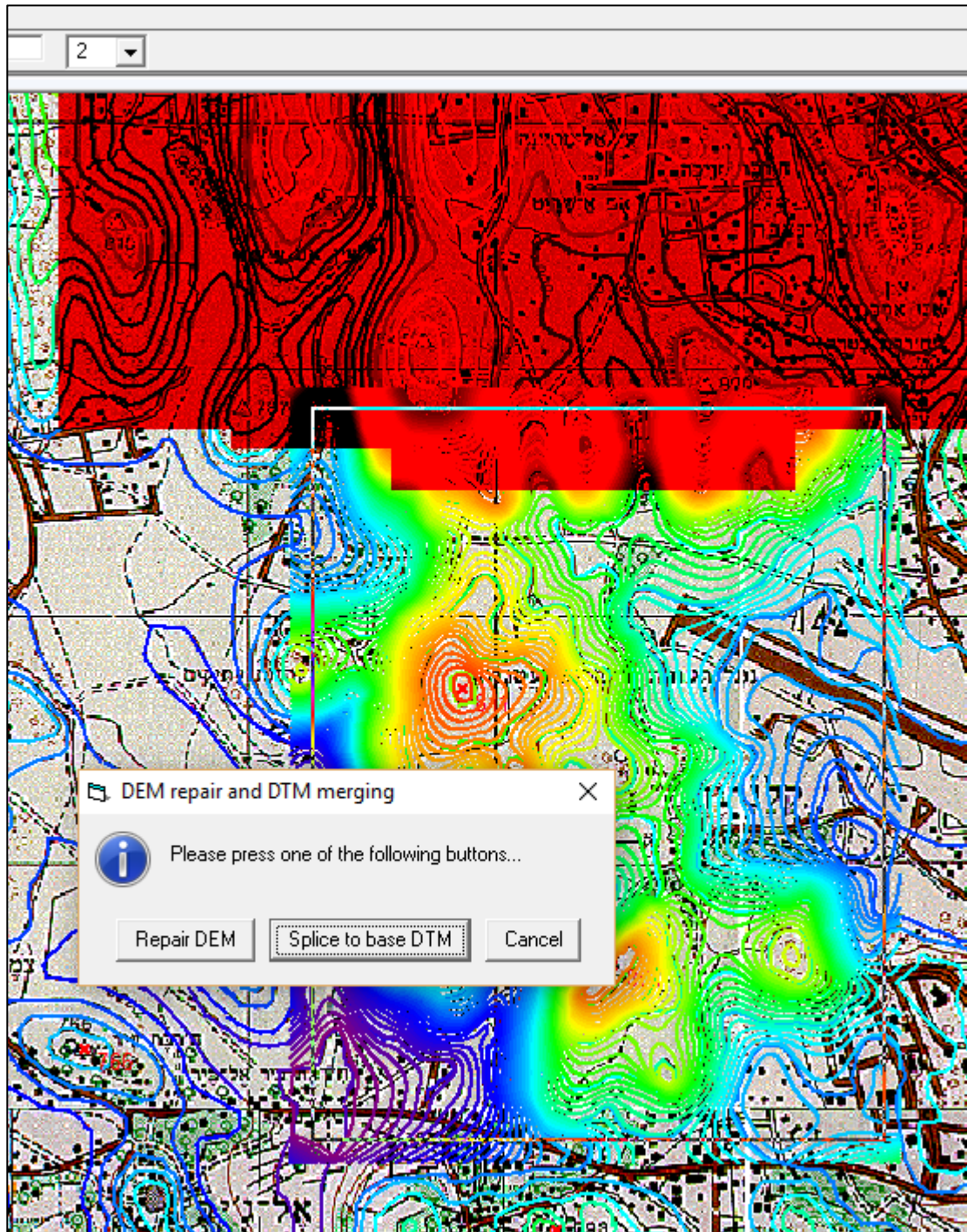

Picture: Colored areas are regions already merged into the base DTM. The rectangle demarks a new region to be merged that has already undergone the Hardy Quadratic Surface calculation (results are drawn as contours). Note that the region must be interior to the region calculated by the Hardy Quadratic Surfaces. It is useful to pick only the region where the surfaces fit the contours, i.e., far from boundaries which haven't yet been digitized.

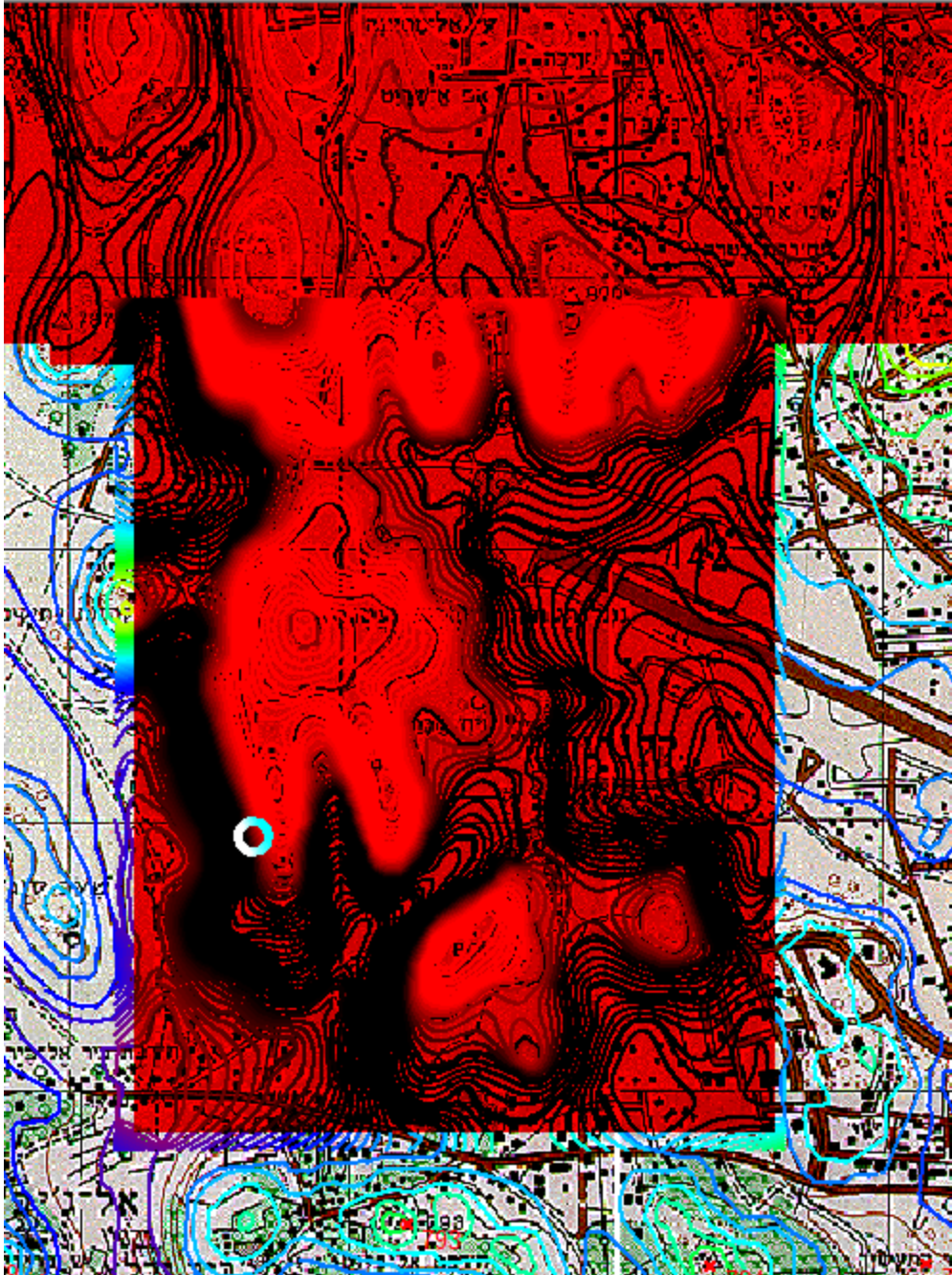

Picture: New region has been marked as merged onto the DTM.

13. In general, borders between different Hardy calculations will not be smooth (the picture below shows several such regions defined by the intersection of merge regions). Notice that the program can handle highly rotated grids to a very high accuracy with the rubber sheeting.

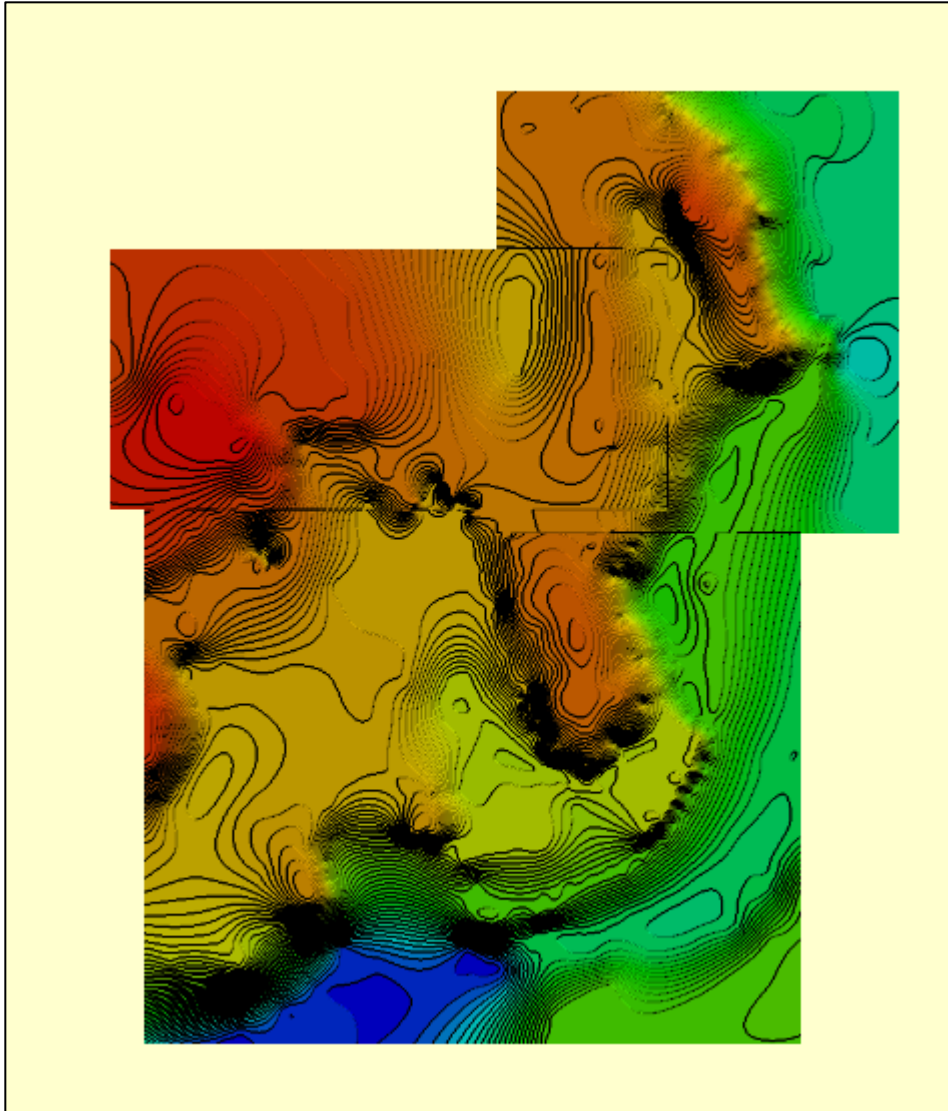

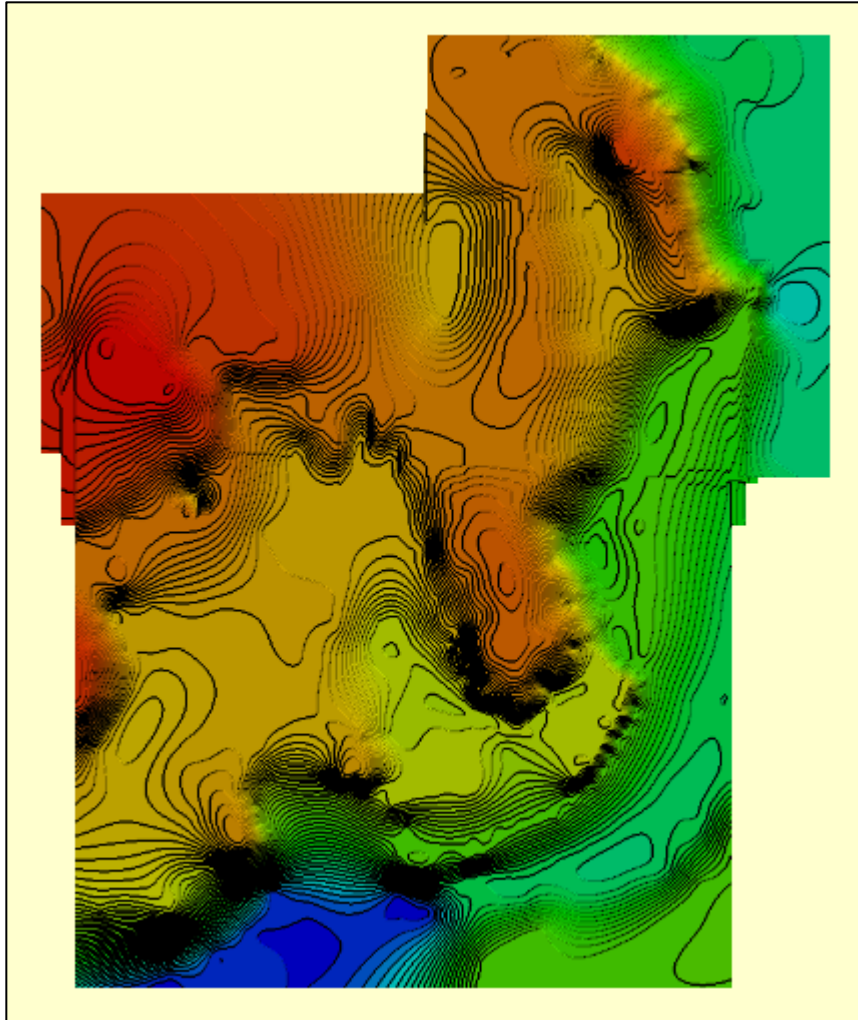

Picture: DTM before smoothing between merged regions (notice that abrupt borders). Steps in elevation are an artifact of calculating the heights to the nearest integer (this setting can be changed in the Options Menu “DTM” tab).



Picture: Finished DTM after smoothing.

2. Once the DTM of a portion of the map has been completed, the program will display those heights when the mouse moves to that region (check the “Use heights based on generated DTM” in the “DTM” tab of the Options menu).
3. The created DTM is written as a standard Surfer version 7 binary “grd” binary file which can be plotted with Surfer or with Global Mapper, etc.

15.10 Contouring and Horizon Profiles

1. Contouring can be done over the map by pressing the “Contour” button  (requires that a source is defined for the elevations). (See picture below). Define a rectangular region to calculate the contours by dragging over that region using the mouse.
2. To view the horizon profile from any point in a contoured region, click on any point. (Rubber sheeting must have been activated so that the point has a geographic latitude and longitude grid in degrees or is an ITM grid; this option doesn't support UTM grids. You must also have set the option to write xyz coordinate files in the “Setting” tab of the Options menu) . Then press the profile button . The

calculation's result is plotted on an interactive graph which shows the distance to the horizon and the theodolite view (angle elevation, i.e., view angle, at any azimuth, i.e., horizontal angular degrees from due East (or West)). The amount of the horizon that is less than a certain distance from the chosen point can be shown by setting a distance and clicking on the purple button. A portion of the graph can be zoomed by dragging over that area. Restore the original axis by pressing the "plot" button.

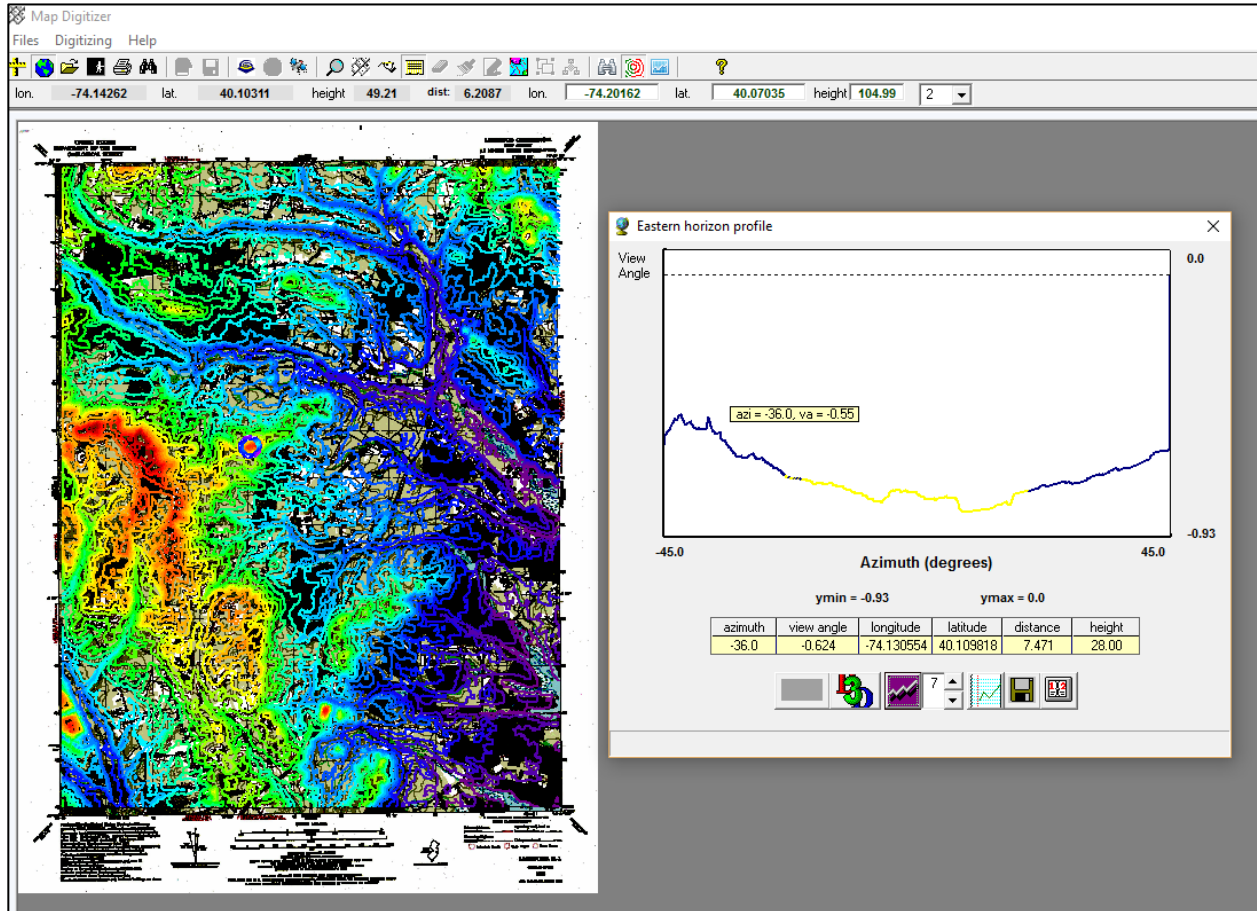

Picture: Map with 2 meter contours (the contour interval can be changed by setting it in the Options dialog "Settings" tag, or by setting it in the drop down list under the toolbar as shown in the picture). The chosen center point is marked on the map. The Eastern horizon from that point has been calculated in the graph. The graph is of view angle (the angle a surveyor measures with a theodolite) versus azimuth (degrees about due East in this example). The yellow portion of the line marks a region in the horizon which is within 7 kilometers of the point. This option is activated by pressing the purple button after setting a distance in kilometers. Notice that there is a display of azimuth, view angle, longitude, latitude, distance, and height at any point of the graph as the mouse moves along the x direction (azimuth).

3. Searching for the highest point in a region: Click on the "Search" button  and drag over the map to define a rectangular region for searching. The program will move the blinking cursor to the highest elevation in the chosen region.

GEBCO OCEAN MAP TOPICS

Chapter 16.0 Finding Gaps to Map

Contributed by K. M. Marks, NOAA Laboratory for Satellite Altimetry, USA

More than 80% of the world's ocean floor is unmapped by echo sounder technologies even at a resolution of about 30 arc seconds (Mayer et al., 2018). Gaps as large as 10^5 km² are devoid of depth soundings. Efforts to fill these gaps with depth measurements, whether by ships of opportunity, crowd-sourced bathymetry, dedicated surveys, or other means first requires a knowledge of where the gaps are. In this chapter, we present two visualizations to help identify gaps in sounding coverage of the ocean floor as well as a GIS method for prioritizing how to fill the gaps. The visualization products include SRTM30_PLUS overlays that may be viewed using Google Earth Pro as well as bathymetric sounding density grids that may be viewed using Esri software. The GIS approach has been used in a pilot seabed mapping project that considered both marine environmental information as well as bathymetric surveys in the prioritization. All products and approaches are freely available on public websites. In the sections below, we provide simple step-by-step instructions for obtaining and using these techniques to find gaps in seafloor depth measurement coverage.

16.1 Google Earth Pro and SRTM30_PLUS Overlays

Contributed by David Sandwell, Scripps Institution of Oceanography, USA and K. M. Marks, NOAA Laboratory for Satellite Altimetry, USA

Google Earth Pro is a geospatial software application that renders views of Earth covered with satellite imagery of selected maps, terrain, oceans, and more. It is available for free download from <https://www.google.com/earth/desktop> (Fig. 16.1).

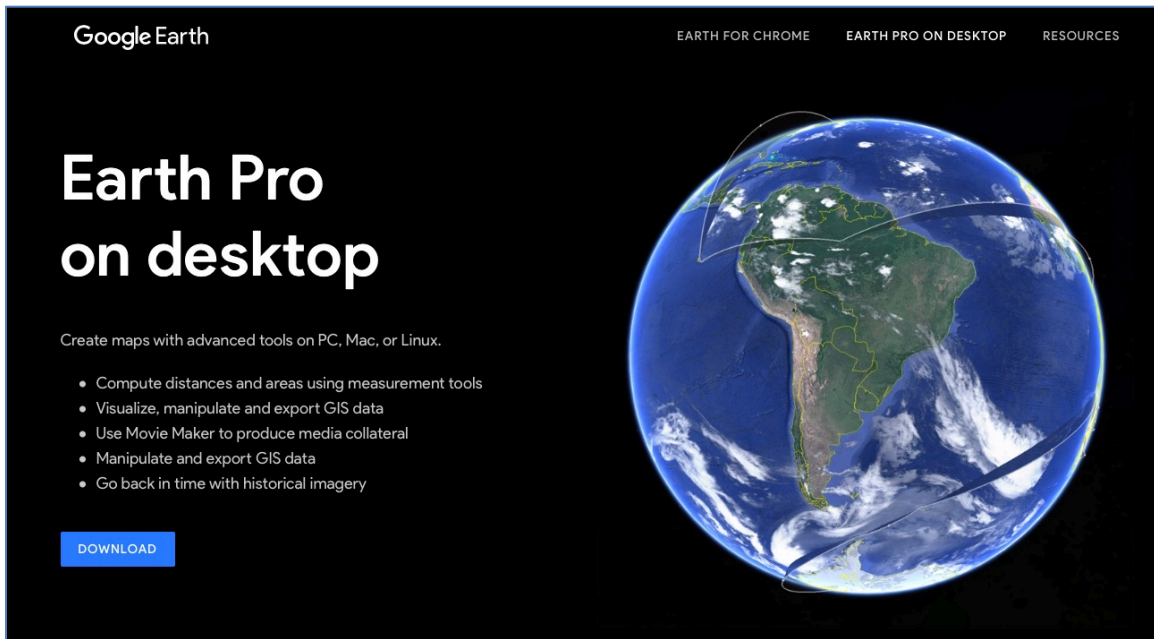

Figure 16.1 Website for downloading Google Earth Pro.

This method of finding the gaps is based on the SRTM30_PLUS 30-arcsecond bathymetry grid and matching source identification grid (SID) compiled by Becker et al., (2009). Both grids are freely available at ftp://topex.ucsd.edu/pub/srtm30_plus/.

These grids have been rendered using Generic Mapping Tools (GMT) as color contoured depth images with grey dots showing the locations of the available soundings (Fig. 16.2) (Sandwell and Wessel, 2010). (Note the Arctic soundings are identical to the IBCAO compilations and they are not displayed above 80° N.)

The Google overlay images are available at http://topex.ucsd.edu/WWW_html/srtm30_plus.html. Click on “Get SRTM30_PLUS Overlays Google Earth” and the file downloads. Once SRTM30_PLUS.kmz is imported into Google Earth Pro, it may be displayed as a layer.

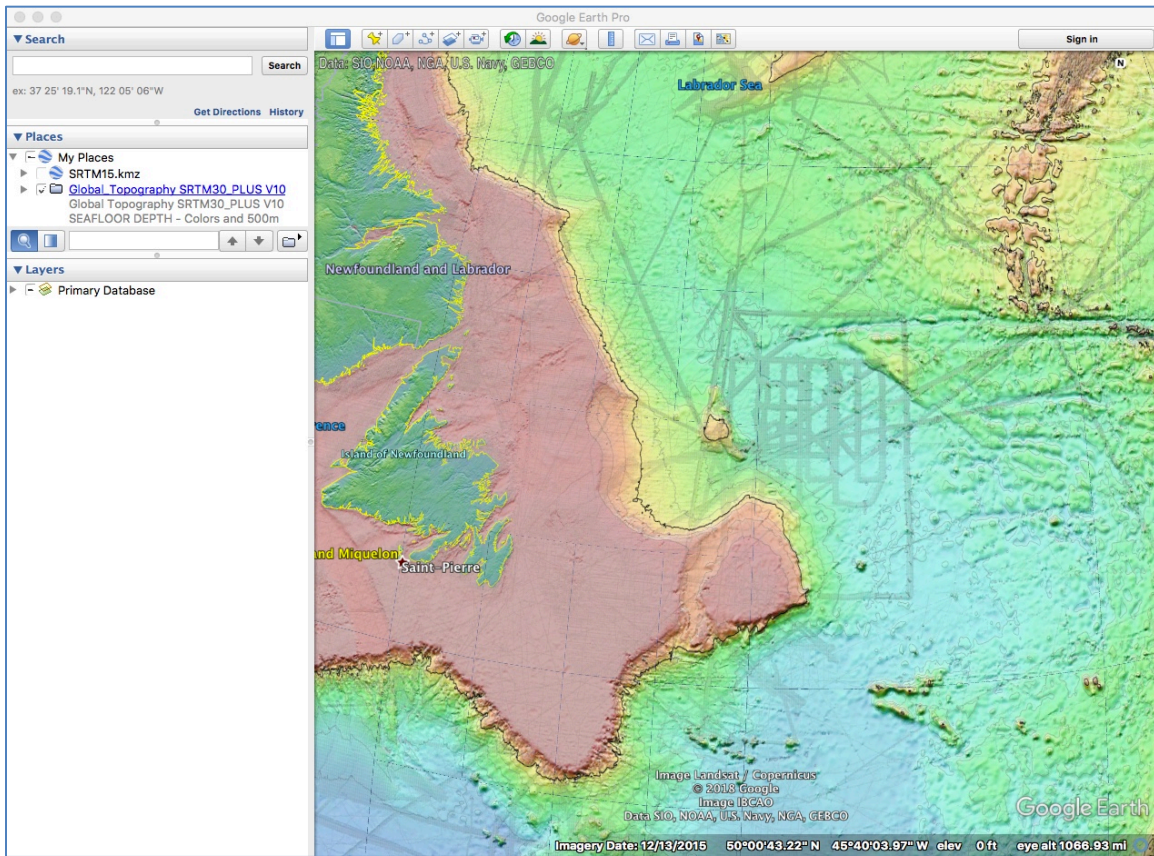

Figure 16.2 SRTM30_PLUS.kmz displayed in Google Earth Pro.

In Fig. 16.2 above, black dots in the Labrador Sea show the locations of grid cells with bathymetric soundings. The large gaps between bathymetric surveys are easy to visualize using this method. Gaps in bathymetric sounding coverage may be searched for globally by focusing the Google Earth Pro window on different ocean locations.

Note that the last update of the SRTM30_PLUS grids was in November of 2014 and the next version will be available in the summer of 2018 along with an updated 15-arcsecond version. The 440 million edited soundings (blockmedianed at 500 m) as well as the metadata used to create these grids, are also freely available from the authors upon request. The SID used by GEBCO (The GEBCO_2014 SID Grid, version 20150318, www.gebco.net) were harmonized with the SRTM_PLUS SID grid in 2014 so for a complete coverage map, the two SID grids and underlying data need to be merged.

16.2 Assessing Gaps via Bathymetric Sounding Density

Contributed by Meredith Westington, NOAA Office of Coast Survey, USA and Jesse Varner, NOAA National Centers for Environmental Information, USA

In support of ocean and coastal mapping strategies, the United States has designed a method for assessing gaps in bathymetry through a visualization of sounding density. This method was first reported by Westington et al. (2018).

This analysis evaluates the openly accessible data holdings at the International Hydrographic Organization's Data Centre for Digital Bathymetry, which is hosted by the National Oceanic and Atmospheric Administration (NOAA) National Centers for Environmental Information (NCEI). All modern depth soundings from 1960 to present are incorporated into 100-m resolution local grids covering the U.S. waters and potential juridical continental shelf. To account for varying definitions of "mapped," the sounding densities are reclassified into two categories: 1 to 2 soundings per cell, which corresponds to "minimally mapped;" and 3 or more soundings per cell, which corresponds to "better mapped." Unmapped areas have no soundings per cell and are blank. The resulting grids are published as a geospatial web service using Esri ArcGIS Enterprise software. Figure 16.3 shows the NOAA GeoPlatform web page with links to the visualization product, <http://noaa.maps.arcgis.com/home/item.html?id=4d7d925fc96d47d9ace970dd5040df0a>.

Bathymetry Gap Analysis

Overview

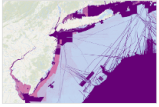

Bathymetric sounding densities of multibeam, single beam, NOS Hydro, NOS BAG, bathymetric LIDAR, and CCOM/JHC extended continental shelf surveys, classified by number of soundings per 100 m cell.

Map Image Layer by NOAA GeoPlatform

Created: Oct 30, 2017 Updated: May 11, 2018 View Count: 127

Authoritative

Description

The United States Bathymetry Gap Analysis is a map service providing visual access to the local sounding density derived from all modern bathymetric data holdings at NOAA's National Centers for Environmental Information (NCEI) and Office for Coastal Management (OCM). A team from NOAA's Office of Coast Survey, the University of New Hampshire Center for Coastal and Ocean Mapping/Joint Hydrographic Center, and NCEI - Colorado prepared this analysis and map service to inform a U.S. ocean and coastal mapping strategy for U.S. waters and contribute to the international Seabed 2030 initiative, which aims to map the entire ocean floor at 100 meter resolution by 2030.

Underpinning the map service are six principal layers of bathymetry. Actual soundings of multibeam data (raw), single beam data (1960 or later), and NOS hydrographic surveys (1960 or later) are included. Coverage footprints of NOS BAG-formatted hydrography, bathymetric grids from the U.S. extended continental shelf survey program, and bathymetric LIDAR data are also included. All bathymetry layers used in the gap analysis are archived at NCEI. For convenience, footprints of bathymetric LIDAR data were retrieved from NOAA's Digital Coast.

To effectively manage server resources, the analysis is partitioned across 177 tiles covering all U.S. waters and adjacent continental shelf. Each tile spans 6 degrees in longitude and 4 degrees in latitude. Within this framework, all modern depth soundings or coverage footprints are extracted from NCEI and OCM data holdings and associated with an approximately 100-m resolution grid of the area. MB_System, GDAL, GMT, and Esri ArcGIS software are used to prepare this analysis.

To simplify the visual presentation and accommodate evolving views on the number of soundings needed for a single 100 m cell to be "mapped", the number of soundings for each grid tile are divided into categories of coverage. Sounding densities greater than 0 and less than 3 are reclassified to a value of 1 and displayed as a deep pink color. Sounding densities equal to 3 or greater are reclassified to a value of 3 and displayed as a deep purple color. The coverage footprints obtained from the BAG-formatted hydrography, offshore extended continental shelf grids, and nearshore bathymetric LIDAR were populated with a value of 3, which represents "fully mapped" in this bathymetry coverage and gap analysis.

Legend:

- 3 or more soundings per ~100m cell
- 1-2 soundings per ~100m cell

Layers

bathy_gap_analysis

Terms of Use

This analysis and map service was designed to inform a U.S. ocean and coastal mapping strategy for U.S. waters as well as contribute to the international Seabed 2030 initiative, which aims to map the entire ocean floor at 100 meter resolution by 2030. The bathymetric data were processed in December 2017-January 2018 and will be updated on a to-be-determined schedule.

Comments (0)

Sign in to add a comment.

[Open in Map Viewer](#)

[Open in Scene Viewer](#)

[Open in ArcGIS Desktop](#)

Details

Source: Map Service
Size: 1 KB
★★★★★
f t g+

Owner

NOAA GeoPlatform

Managed by: ncei_noaa

Tags

NOAA, sounding density, bathymetry, Seabed 2030, bathymetry gap analysis, bathy gap analysis

Credits (Attribution)

NOAA Office of Coast Survey (OCS), University of New Hampshire Center for Coastal and Ocean Mapping/Joint Hydrographic Center, NOAA National Centers for Environmental Information (NCEI), NOAA Office for Coastal Management (OCM)

URL

<https://gis.ngdc.noaa.gov/arcgis/rest/sr> View

Figure 16.3 NOAA GeoPlatform web page for the Bathymetry Gap Analysis.

This service can be viewed through free GIS software. The 'Open in Map Viewer' link from the page shown in Figure 16.3 will allow one to pan/zoom around the gap analysis product using a free Esri software viewer. Figure 16.4 depicts the gap analysis product using this viewer.

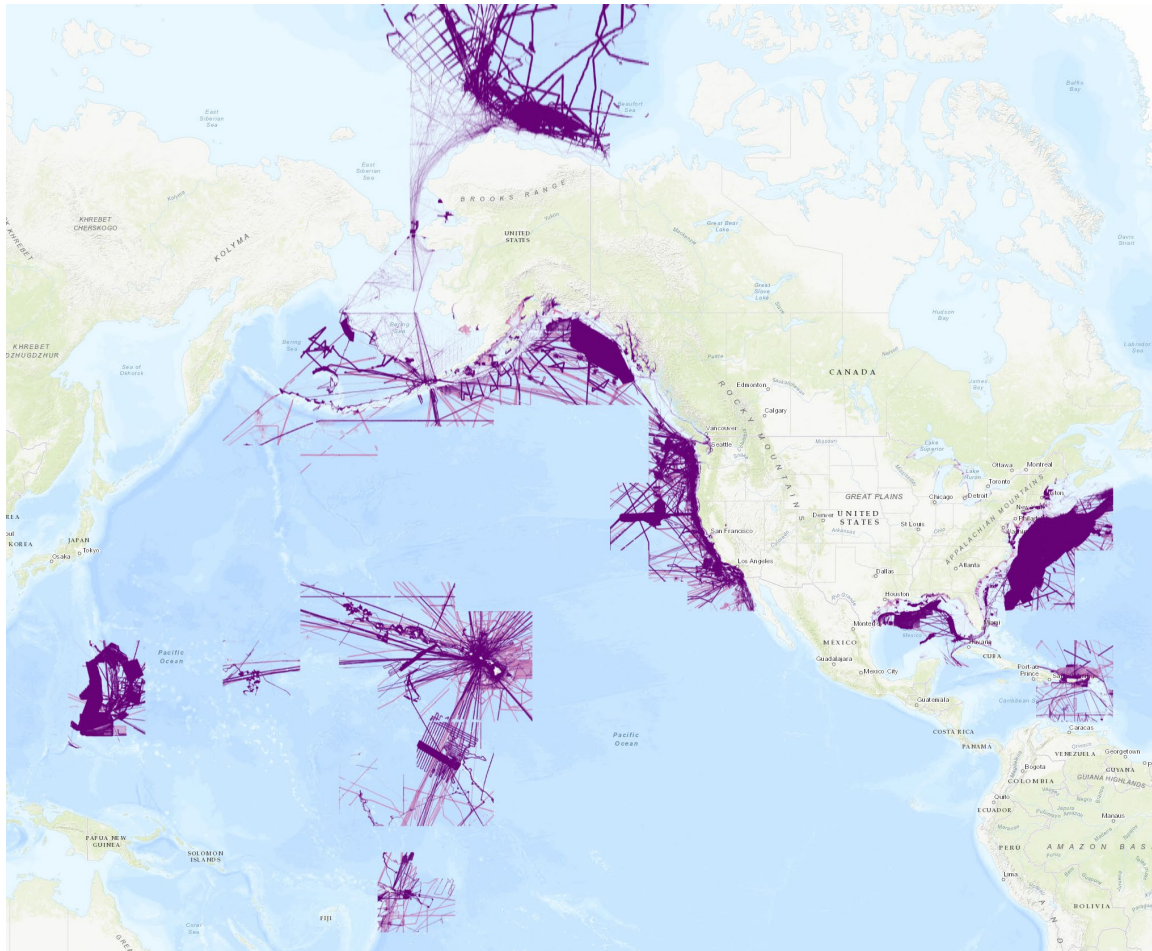

Figure 16.4 The Bathymetry Gap Analysis as depicted in Esri’s online map viewer application.

This bathymetry gap analysis is also easily added to other GIS web mapping applications, such as the U.S. Federal Mapping Coordination website (Figure 16.5).

The service can also be used in desktop GIS applications such as ArcGIS or QGIS, by pointing to the ArcGIS REST endpoint (https://gis.ngdc.noaa.gov/arcgis/rest/services/bathy_gap_analysis/MapServer), or by clicking the “Open in ArcGIS Desktop” link shown in Figure 16.3, or by using the Open Geospatial Consortium (OGC) Web Map Service (WMS) endpoint (https://gis.ngdc.noaa.gov/arcgis/services/bathy_gap_analysis/MapServer/WMServer?request=GetCapabilities&service=WMS).

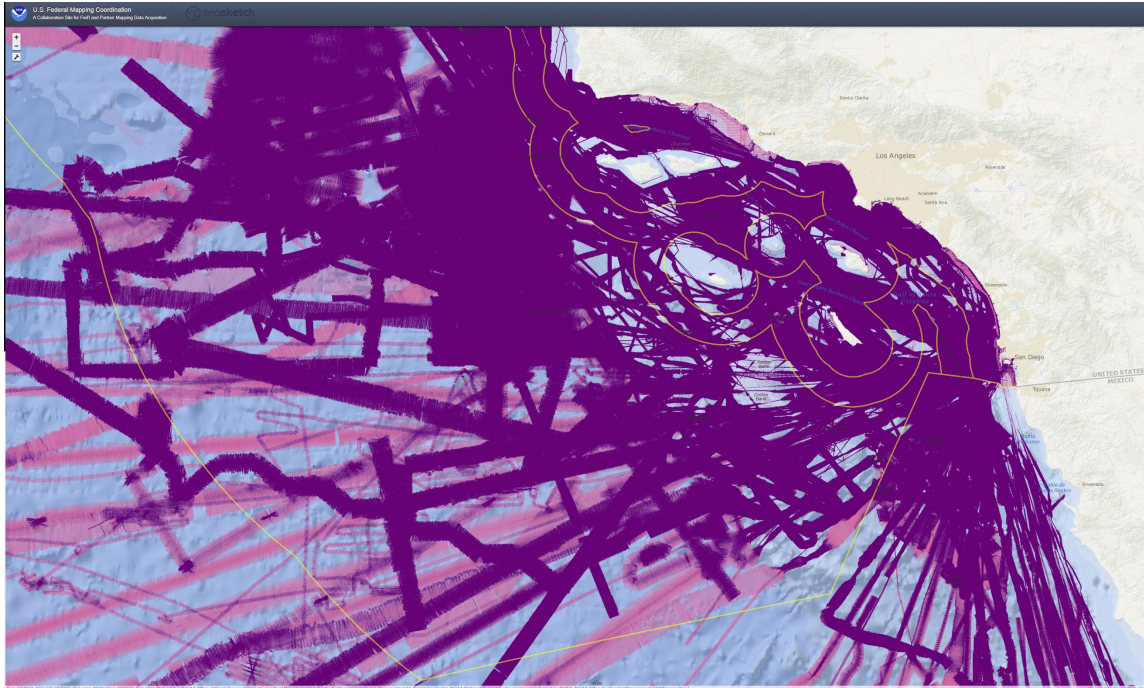

Figure 16.5 The bathymetry gap analysis as a layer in the U.S. Federal Mapping Coordination website (www.fedmap.seasketch.org).

Support for displaying this service in Google Earth Pro is limited. Here are some instructions for adding an image overlay using the WMS endpoint:

1. Go to the “Add” menu, then “Image Overlay”.
2. Under the “Refresh” tab, click on “WMS Parameters”.
3. Enter https://gis.ngdc.noaa.gov/arcgis/services/bathy_gap_analysis/MapServer/WMSServer as the URL and add the two available layers to the “Selected Layers” panel, then click OK.
4. In the link displayed, change the “FORMAT=image/gif” to “FORMAT=image/png32”. This allows the image to be displayed with smooth transparency, without a white halo.
5. The image overlay should now display in Google Earth, refreshing whenever the view stops moving. However, it will not display properly if the antimeridian (180 degrees longitude) is in the view.

This gap analysis is a first look at how many individual depth measurements contribute to the overall picture of “mapped.” One may argue that a single measurement in a 100-m grid cell (the pink areas show in Figure 16.5) is not adequate to constitute “mapped;” however, when considering that less than 10% of the global seafloor has been mapped by high-resolution multibeam surveys (Mayer et al., 2018), others may equally argue that one sounding is better than no sounding at all. This product is designed to start a conversation about what it means for an area to be “mapped” and support actions to fill the gaps.

16.3 A GIS Approach to Prioritizing the Gaps to Map

Contributed by Jennifer Jencks, NOAA National Centers for Environmental Information, USA and Anne-Cathrin Wöfl, GEOMAR Helmholtz Centre for Ocean Research, Germany

A method of identifying potential areas for future mapping initiatives was recently published by Wöfl et al. (2017). The selection algorithm involved a GIS-based overlay technique that included selected parameters of the marine environment as individual layers and combined them in order to obtain information about the suitability of a location as a target area. Combined with information on bathymetry coverage, the results revealed the suitability of areas throughout the North Atlantic and highlighted three potential pilot mapping sites. This methodology can be adapted to other regions and can include a variety of parameters based on stakeholder interest.

16.3.1 General Criteria and Input Parameters

The aim of the North Atlantic analysis was to show the suitability of every 400 x 400 km cell as a potential target site within the study area. The basic assumption was that the greater the number of parameters present at a certain site, the higher its suitability. As a starting point, a grid of 400 x 400 km cells, referred to as polygons, was generated and overlaid on the study area. The grid was created in a Lambert azimuthal equal-area projection centered over the North Atlantic (central meridian 35°W, latitude of origin 45°N), to ensure that each polygon represents the same area. The choice of polygon size was based on the calculation that, with an appropriately equipped vessel, one polygon could be surveyed within approximately 100 days. The exclusion of the EEZ and potential juridical continental shelves resulted in the cropping and reduction of the polygon sizes.

A key step in the analysis was to determine where bathymetric data were already available. Perhaps surprisingly, this was not a trivial task as only a small percentage of existing multibeam data and associated geographic information is easily accessible through online repositories. To determine the current data coverage in an area, multibeam swaths from open access online databases ([IHO DCDB](#), [GMRT Data Synthesis](#), and [EMODnet Bathymetry](#)) were combined and displayed. Datasets from all three repositories, and others, can be visualized together in the [IHO DCDB](#) viewer. Where only survey tracks were available and the swath coverage was unknown, a buffer of 2.5 km around the track was used (Figure 16.6). A single beam density grid from NOAA, showing the number of soundings per 0.02° cell was also analyzed but not included in the data coverage calculations, due to the lack of significant spatial coverage of single beam data in areas where multibeam coverage did not already exist.

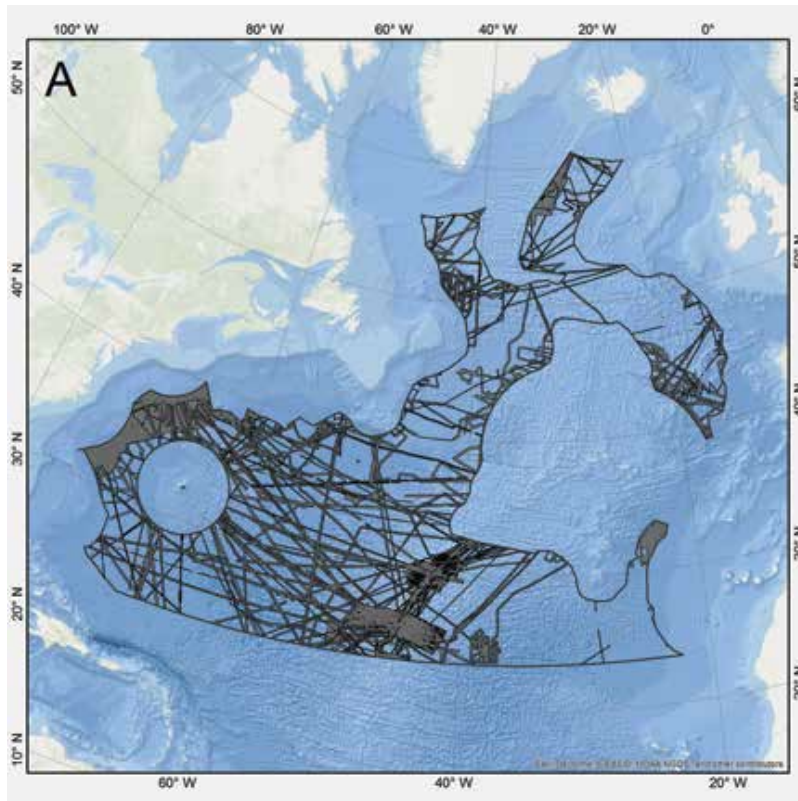

Figure 16.6 Overview map of the study area showing available multibeam data coverage from the IHO DCDB, GMRT Synthesis, EMODnet and from the Spanish and Portuguese national archives (from Wöfl et al. (2017) with permission of The Journal of Ocean Technology).

Next, a set of parameters was identified based on the interests of specific user groups, such as the general public, science and industry:

- Ecologically or Biologically Significant Marine Areas (EBSA)
- Marine Protected Areas Network (MPA)
- Vulnerable Marine Ecosystems (VME)
- Flight Lines (FL)
- Shipping Lanes (SL)
- Important Areas for Cobalt-Rich Ferromanganese Crust Formation (FMC)
- Important Areas for Manganese Nodule Formation (MN)
- Important Areas for Massive Sulphide Formation (MS)

The parameters were then grouped into three categories including i) Environmentally-Sensitive Areas (EBSA, MPA, VME), ii) Areas of Public Interest (FL, SL) and iii) Areas with Marine Resource Potential (FMC, MN, MS) to ensure a balance between user-group interests (Figure 16.7).

These parameters reflect the attributes a potential target area could possess in order to increase its suitability for future planned bathymetric surveys. However, any variety of parameters could be selected based on stakeholder interest.

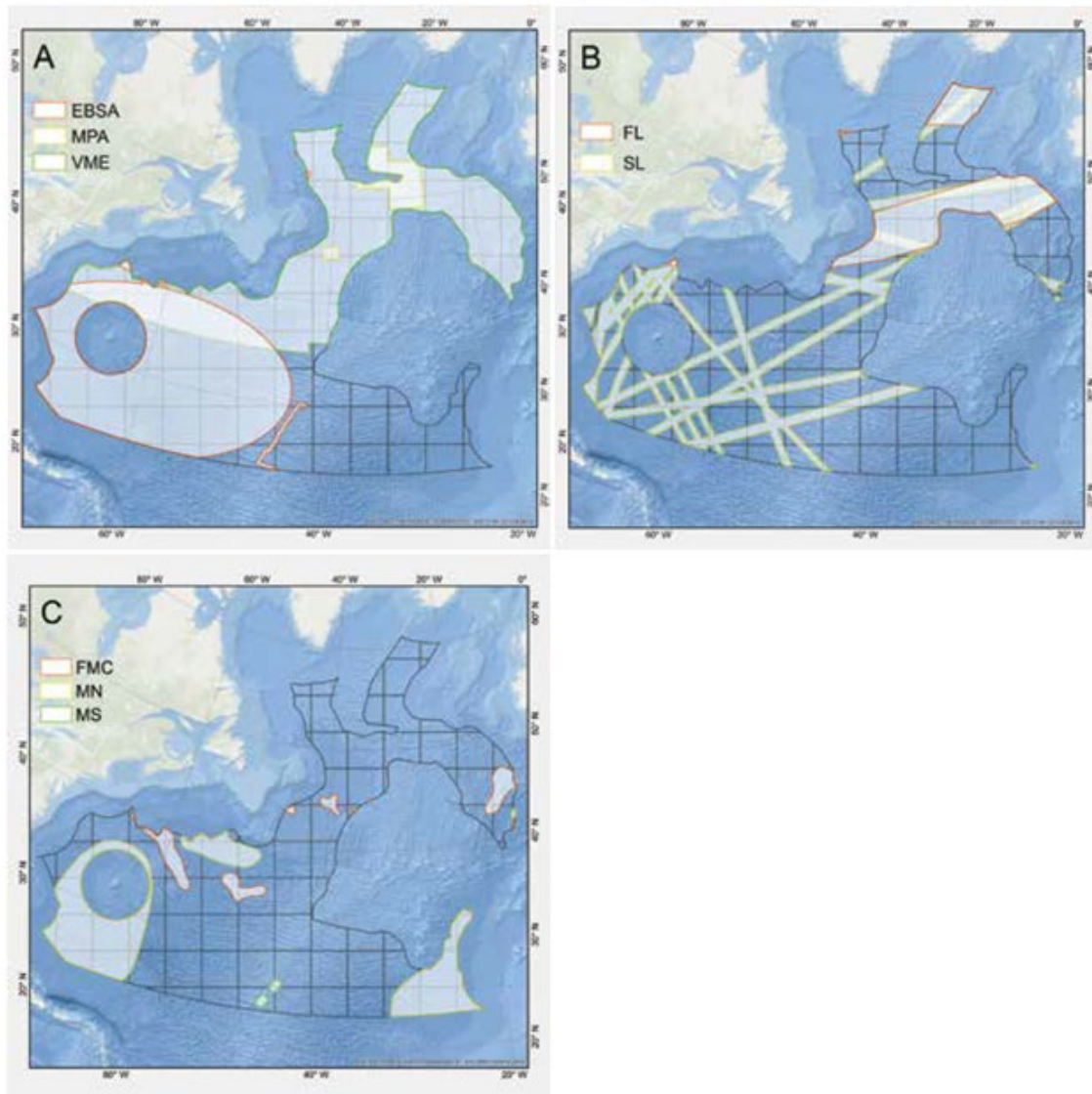

Figure 16.7 GIS parameter layers for the GIS suitability analysis: A. Category I, Environmentally-sensitive areas, B. Category II, Areas of public interest, C. Category III, Areas with marine resource potential (from Wölfl et al. (2017) with permission of The Journal of Ocean Technology).

16.3.2 GIS-Based Suitability Analysis

The GIS analysis was performed with ArcGIS 10.4, but is also applicable with other common GIS software. First, the three categories were integrated into the GIS as individual geospatial vector layers (shapefiles) and merged according to their categorization. Next, the three category layers were converted to raster data sets with a cell size of 1 x 1 km to obtain high resolution information. Cells with no data were assigned a value of 0 reflecting the absence of parameters. A value of 1 was assigned to cells containing data, indicating the occurrence of at least one

parameter within this cell. Finally, an expression was executed adding all values of the three category raster data sets in each cell using the Raster Calculator geoprocessing tool in the Spatial Analyst toolbox (Figure 16.8). The output was a newly created raster data set that shows the spatial overlap of the categories. A very low suitability stands for the absence of all categories, a low suitability for the occurrence of one category, a medium suitability for the occurrence of two categories and a high suitability for the occurrence of all three categories.

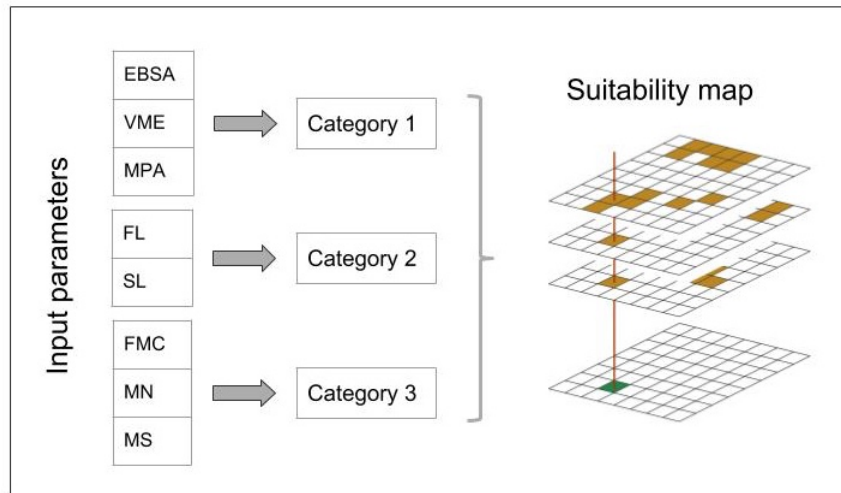

Figure 16.8 Workflow of data preparation and GIS suitability analysis (from Wöfl et al. (2017) with permission of The Journal of Ocean Technology).

16.3.3 Results and Discussion

Figure 16.9 shows the results of the suitability analysis based on select stakeholder interests. For visualization purposes, the multibeam data coverage was classified into four bands (0-25%, 25-50%, 50-75% and 75-100%) for each polygon. A high occurrence of desired attributes at a specific location results in a high suitability as a potential target site. The three selected regions chosen from our study, showed not only a high occurrence of desired attributes, reflected in a high suitability class, but also a relatively low multibeam data coverage.

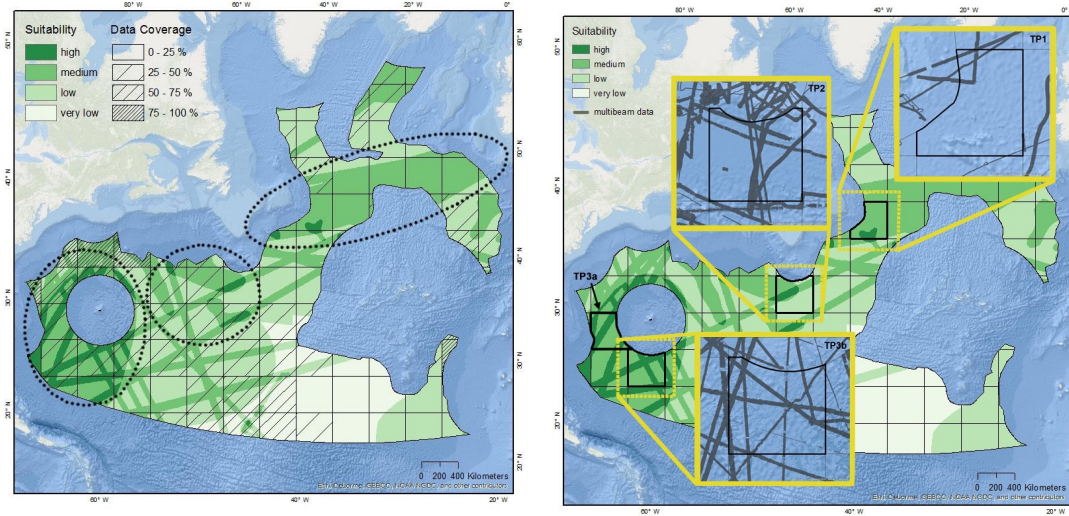

Figure 16.9 (Left) Result map showing the suitability of potential target sites and the percentage of multibeam data coverage divided into four classes. High suitability regions are highlighted (dotted line). (Right) The three selected regions showing not only a high occurrence of desired attributes, reflected in a high suitability class, but also relatively low multibeam data coverage. From Wölfl et al. (2017) with permission of The Journal of Ocean Technology.

However, it is acknowledged that the interdependencies between some of the selection criteria (eg: data coverage density and the designation of Environmentally Sensitive Areas) can lead to the suitability of some areas being underestimated. For example, many marine protected areas are designated based on knowledge of the seafloor (eg: data coverage). Therefore, we affirm that all unmapped regions warrant further study. It is also worth mentioning, that gaining knowledge about the seafloor could be significantly improved if all bathymetric data would be publically available and accessible to all.

The value of this approach is that it can be easily adjusted and repeated to include new criteria depending on interest, or new data as they become available. It provides an objective way to prioritize mapping areas.

References

Becker, J. J., D. T. Sandwell, W. H. F. Smith, J. Braud, B. Binder, J. Depner, D. Fabre, J. Factor, S. Ingalls, S-H. Kim, R. Ladner, K. Marks, S. Nelson, A. Pharaoh, R. Trimmer, J. Von Rosenberg, G. Wallace, P. Weatherall., Global Bathymetry and Elevation Data at 30 Arc Seconds Resolution: SRTM30_PLUS, *Marine Geodesy*, 32:4, 355-371, 2009.

Mayer, L., Jakobsson, M., Allen, G., Dorschel, B., Falconer, R., Ferrini, V., Lamarche, G., Snaith, H., and Weatherall, P., “The Nippon Foundation-GEBCO Seabed 2030 Project: The Quest to See the World’s Oceans Completely Mapped by 2030,” *Geosciences*, 8:63, 2018. doi:10.3390/geosciences8020063.

Sandwell, D. T., Wessel, P., “Seamount discovery tool aids navigation to uncharted seafloor features,” *Oceanogr.*, 23:1, 2010.

Westington, M., Varner, J., Johnson, P., Sutherland, M., Armstrong, A., & Jencks, J. 2018, ‘Assessing Sounding Density for a Seabed 2030 Initiative’, in proceedings of the 2018 Joint Canadian Hydrographic and National Surveyors’ Conference, Victoria, British Columbia, 26-29 March 2018, <https://www.eiseverywhere.com/ehome/chc-nsc2018/711593/>.

Wöfl A.-C., Jencks J., Johnston G., Varner J., Devey C., “Identifying deep-sea target areas for a pilot Atlantic seabed mapping project using GIS techniques,” *Journ. Technology*, 12:4, 28-42, 2017.

Chapter 17.0 Developing a Type Identifier (TID) Grid

This chapter discusses the development of the Type Identifier (TID) grid to accompany gridded bathymetry data submissions for inclusion in the global GEBCO grid.

Contributed by Pauline Weatherall and Helen Snaith, British Oceanographic Data Centre (BODC), UK

The global GEBCO bathymetric grid is accompanied by a Type Identifier (TID) Grid; the function of the TID grid is to identifier the source data type that the corresponding grid cell in the GEBCO bathymetric grid is based on. The aim is to allow users of the GEBCO grid to assess the ‘quality’ of the grid in a particular area, i.e. if it is based on a multibeam survey or on interpolation etc.

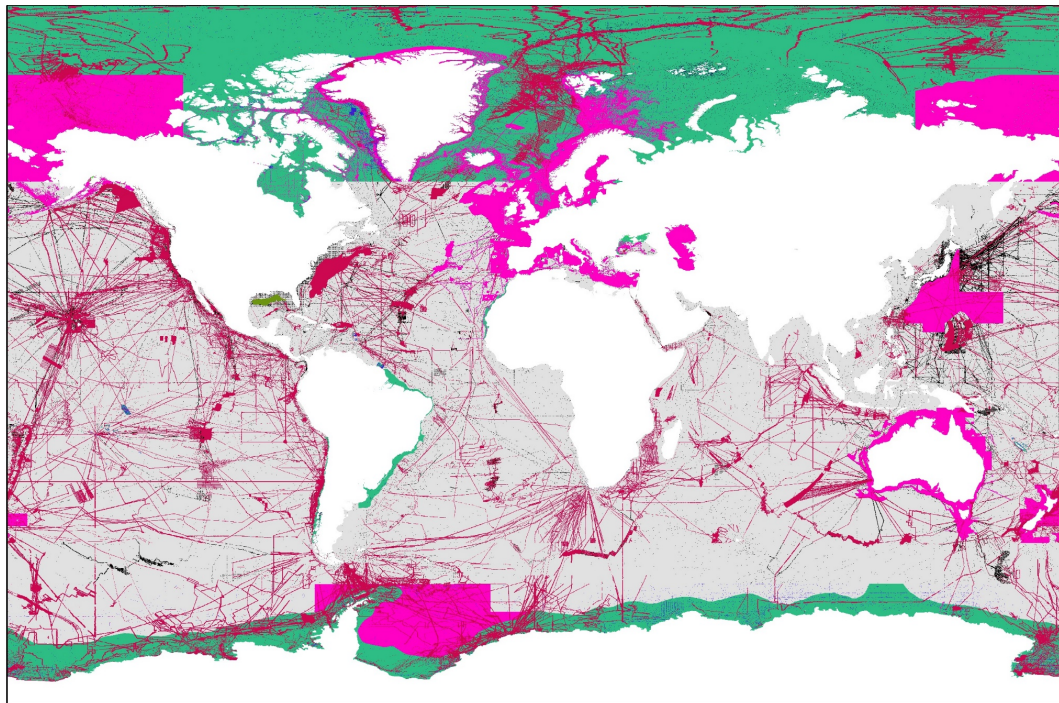

Legend		
10 - Singlebeam	13 - Isolated sounding	41 - Interpolated based on a computer algorithm
11 - Multibeam	14 - ENC sounding	42 - Digital bathymetric contours from charts
12 - Seismic	15 - Lidar	44 - Constrained by a bathymetric sounding in a grid of type 40
40 - Predicted based on satellite-derived gravity data	70 - Pre-generated grid	71 - Unknown source
		72 - Steering points

Figure 17.1 The TID Grid that accompanies the GEBCO_2019 bathymetric grid.

A list of TID data type codes and their definitions is given in the table below.

Data type	TID Code
Land	0
Direct measurements	
Singlebeam - depth value collected by a single beam echo-sounder	10
Multibeam - depth value collected by a multibeam echo-sounder	11
Seismic - depth value collected by seismic methods	12
Isolated sounding - depth value that is not part of a regular survey or trackline	13
ENC sounding - depth value extracted from an Electronic Navigation Chart (ENC)	14

Data type	TID Code
Lidar - depth derived from a bathymetric lidar sensor	15
Depth measured by optical light sensor	16
Combination of direct measurement methods	17
In-direct Methods	
Predicted based on satellite-derived gravity data - depth value is an interpolated value guided by satellite-derived gravity data	40
Interpolated based on a computer algorithm - depth value is an interpolated value based on a computer algorithm (e.g. Generic Mapping Tools)	41
Digital bathymetric contours from charts - depth value taken from a bathymetric contour data set	42
Digital bathymetric contours from ENC's - depth value taken from bathymetric contours from an Electronic Navigation Chart (ENC)	43
Bathymetric sounding - depth value at this location is constrained by bathymetric sounding(s) within a gridded data set where interpolation between sounding points is guided by satellite-derived gravity data	44
Predicted based on helicopter/flight-derived gravity data	45
Unknown	
Pre-generated grid - depth value is taken from a pre-generated grid that is based on mixed source data types, e.g. single beam, multibeam, interpolation etc.	70
Unknown source - depth value from an unknown source	71
Steering points - depth value used to constrain the grid in areas of poor data coverage	72

Table 17.1 List of TID data type codes and definitions.

The following images show examples of the TID grid. Being able to identify areas based on various data types for inside pre-generated grids is particularly useful.

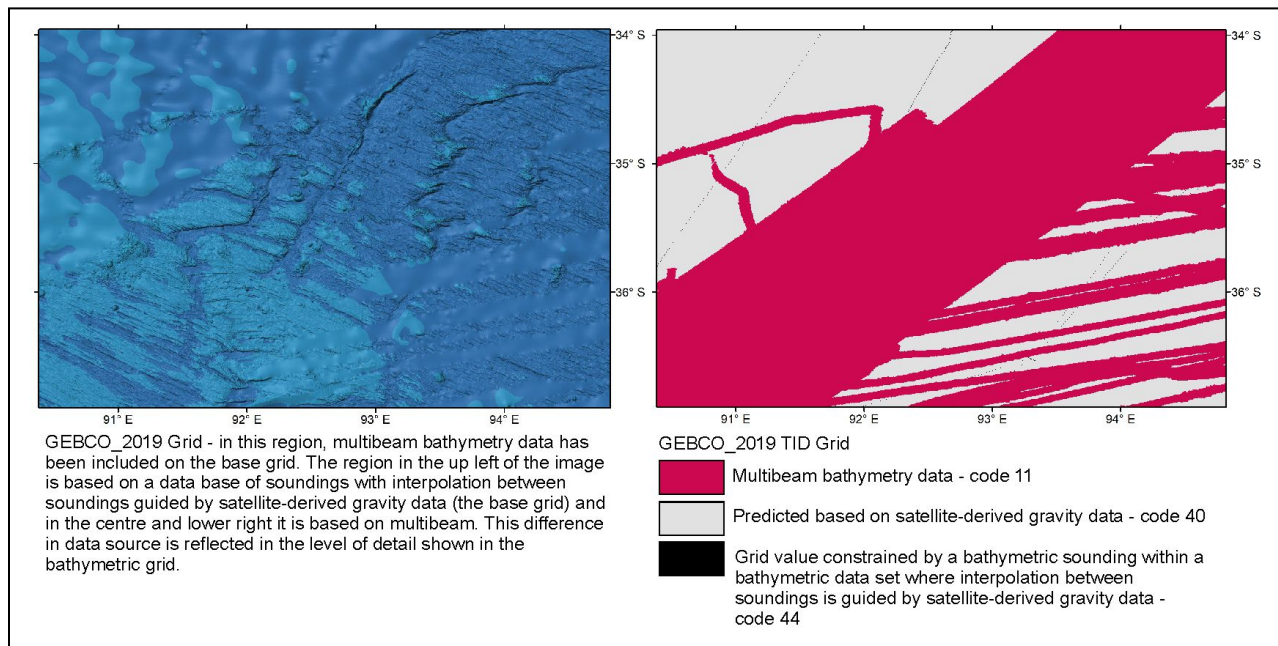

Figure 17.2 Example section of the TID grid.

The image below shows the TID Grid for a section of the GEBCO_2019 Grid that has been developed from multiple data sources. The image on the left has the region coded as a pre-generated grid (shown in pink). The image on the right has the individual data contributions for this ‘pre-generated’ area coded for their source data type. This makes it easier for users to assess the quality of the grid in particular regions and also allows us to determine what portions of this area are actually mapped using echo-sounding techniques and which are interpolated – helping with the concept of identifying and ‘mapping the gaps.’

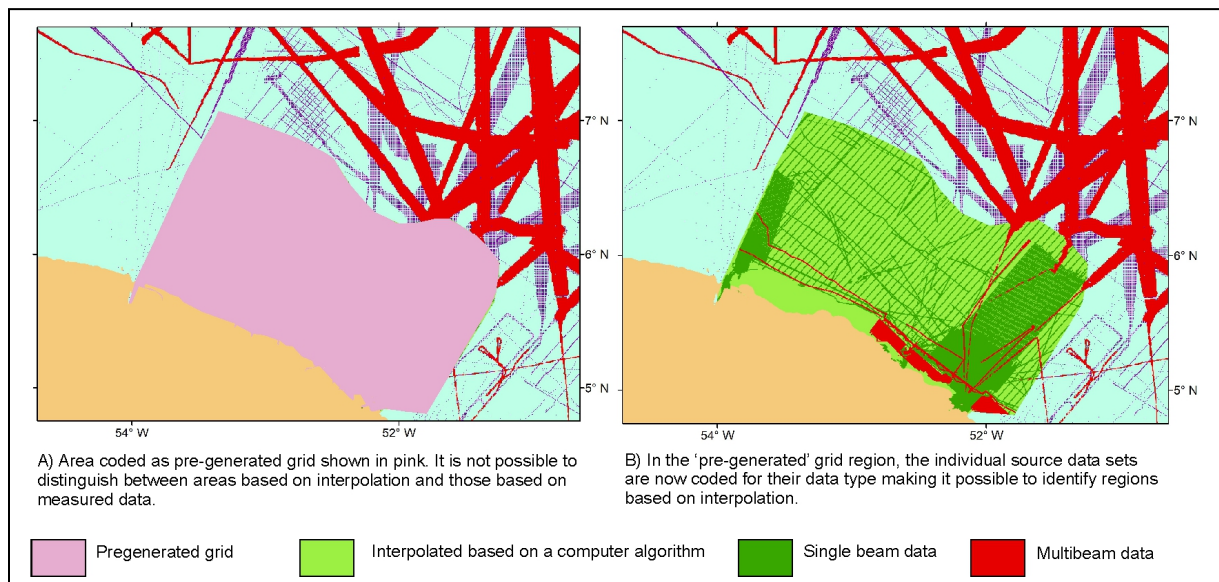

Figure 17.3 Showing how coding areas of 'pre-generated grid' with the contributing data type codes helps identify regions in the global grid that are based on interpolation.

17.1 Developing the TID Grid from Source Data

How a section of TID grid is generated depends on the systems/software used by the grid compiler. The following example uses routines from Generic Mapping Tools (GMT) <http://gmt.soest.hawaii.edu/projects/gmt/wiki/Documentation>.

Example: Developing a TID grid for areas based on isolated soundings or single beam tracks, i.e. data file consisting of xyz points with interpolation between the soundings guided by an interpolation algorithm

This method assigns a TID code value to cells that contain a data point other grid cells are coded as based on interpolation by computer algorithm.

The box below shows an example input x,y,z file where the 'z' value contains the TID code.

```
16.84072200 -29.23058900 14
16.92189400 -29.36181300 14
16.91394600 -29.35319700 10
16.83472800 -29.18163600 10
16.87251300 -29.27743000 10
```

In this example, it is assumed that the TID input file ‘input.xyz’ has been generated from the input data files used to generate the bathymetric grid and with the ‘z’ field now coded to the appropriate TID value.

The GMT routine ‘xyz2grd’ (<http://gmt.soest.hawaii.edu/doc/5.3.2/xyz2grd.html>) could be used to make a TID grid for this data set

```
xyz2grd input.xyz -R15/17/-31/-29 -I15s -r -V -N41 -GTID_grid.nc
```

The above generated a 15 arc-second, pixel registered grid, with the grid cells that contain a data point assigned a TID value. It is assumed that areas between data points are based on interpolation by a computer algorithm and are assigned the TID value ‘41’. This is achieved by including the argument ‘-N41’ – this assigns all null grid cells with a particular value.

Annexes

Annex A Additional Resources

Multibeam Data

Baltic Sea Bathymetry Database

<http://data.bshc.pro>

Earthref.org Seamount Catalog

<http://earthref.org/SC>

European Marine Observation and Data Network

<http://www.emodnet-hydrography.eu/>

Geoscience Australia

<http://www.ga.gov.au/index.html>

University of Hawaii

<http://www.soest.hawaii.edu/HMRG/Multibeam/index.php>

Japan Agency for Marine-Earth Science and Technology (JAMSTEC):

<http://www.godac.jamstec.go.jp/darwin/e>

Lamont Doherty Earth Observatory Marine Geoscience Data System

<http://www.marine-geo.org/portals/gmrt/>

National Centers for Environmental Information (NCEI)

<http://www.ngdc.noaa.gov/mgg/bathymetry/multibeam.html>

Center for Coastal & Ocean Mapping, Joint Hydrographic Center, University of New Hampshire

<http://ccom.unh.edu/theme/law-sea>

Submarine Arctic Science Program (SCICEX) data

http://nsidc.org/scicex/data_inventory.html

Stockholm University Oden Mapping Data Repository

<http://oden.geo.su.se>

Bathymetry Models

Altimetric Bathymetry Grid (Smith and Sandwell, 1997)

http://topex.ucsd.edu/WWW_html/mar_topo.html

GEBCO 30 arc-second Bathymetry Grid

<http://www.gebco.net>

International Bathymetric Chart of the Southern Ocean (IBCSO)

<http://www.ibcso.org/data.html>

International Bathymetric Chart of the Arctic Ocean (IBCAO)

<http://www.ngdc.noaa.gov/mgg/bathymetry/arctic/>

SRTM30_Plus

http://topex.ucsd.edu/WWW_html/srtm30_plus.html

Annex B Glossary

S-44 Terms

The following has been extracted from "IHO Publication S-44 Standards for Hydrographic Surveys" and edited for context.

Note: The terms defined below are those that are most relevant to this publication. A much larger selection of terms are defined in IHO Publication S-32 (Hydrographic Dictionary) and this should be consulted if the required term is not listed here. S-32 is available as an on-line Wiki at: http://hd.iho.int/en/index.php/Main_Page.

Accuracy: The extent to which a measured or enumerated value agrees with the assumed or accepted value (see: *uncertainty, error*).

Bathymetric Model: A digital representation of the topography (bathymetry) of the sea floor by coordinates and depths.

Blunder: The result of carelessness or a mistake; may be detected through repetition of the measurement.

Confidence interval: See *uncertainty*.

Confidence level: The probability that the true value of a measurement will lie within the specified *uncertainty* from the measured value. It must be noted that confidence levels (e.g. 95%) depend on the assumed statistical distribution of the data and are calculated differently for 1 Dimensional (1D) and 2 Dimensional (2D) quantities. In the context of this standard, which assumes Normal distribution of error, the 95% confidence level for 1D quantities (e.g. depth) is defined as 1.96 x sigma and the 95% confidence level for 2D quantities (e.g. position) is defined as 2.45 x sigma.

Correction: A quantity which is applied to an observation or function thereof, to diminish or minimize the effects of errors and obtain an improved value of the observation or function. It is also applied to reduce an observation to some arbitrary standard. The correction corresponding to a given error is of the same magnitude as the computed error but of opposite sign.

Error: The difference between an observed or computed value of a quantity and the true value of that quantity. (N.B. The true value can never be known, therefore the true error can never be known. It is legitimate to talk about error sources, but the values obtained from what has become known as an error budget, and from an analysis of residuals, are *uncertainty* estimates, not errors. See *uncertainty*.)

Metadata: Information describing characteristics of data, e.g. the *uncertainty* of survey data. ISO definition: Data (describing) about a data set and usage aspect of it. Metadata is data implicitly attached to a collection of data. Examples of metadata include overall quality, data set title, source, positional *uncertainty* and copyright.

Quality assurance: All those planned and systematic actions necessary to provide adequate confidence that a product or a service will satisfy given requirements for quality.

Quality control: All procedures which ensure that the product meets certain standards and specifications.

Reduced depths: Observed depths including all *corrections* related to the survey and post processing and reduction to the used vertical datum.

Sounding datum: The vertical datum to which the soundings on a hydrographic survey are reduced. Also called ‘datum’ for sounding reduction.

Total horizontal uncertainty (THU): The component of *total propagated uncertainty* (TPU) calculated in the horizontal plane. Although THU is quoted as a single figure, THU is a 2D quantity. The assumption has been made that the uncertainty is isotropic (i.e. there is negligible correlation between errors in latitude and longitude). This makes a Normal distribution circularly symmetric allowing a single number to describe the radial distribution of errors about the true value.

Total propagated uncertainty (TPU): the result of uncertainty propagation, when all contributing measurement uncertainties, both random and systematic, have been included in the propagation. Uncertainty propagation combines the effects of measurement uncertainties from several sources upon the uncertainties of derived or calculated parameters.

Total vertical uncertainty (TVU): The component of *total propagated uncertainty* (TPU) calculated in the vertical dimension. TVU is a 1D quantity.

Uncertainty: The interval (about a given value) that will contain the true value of the measurement at a specific *confidence level*. The *confidence level* of the interval and the assumed statistical distribution of errors must also be quoted. In the context of this standard the terms uncertainty and *confidence interval* are equivalent.

Uncertainty Surface: A model, typically grid based, which describes the depth uncertainty of the product of a survey over a contiguous area of the skin of the earth. The uncertainty surface should retain sufficient *metadata* to describe unambiguously the nature of the uncertainty being described.

Annex C Acronyms and Abbreviations

A

ASCII American Standard Code for Information Interchange

B

BAG Bathymetry Attributed Grid

BODC British Oceanographic Data Centre (UK)

C

CHS Canadian Hydrographic Service

CIOH Centro de Investigaciones Oceanograficas e Hidrográficas (Columbia)

CIRES Cooperative Institute for Research in Environmental Sciences (USA)

D

DEM Digital Elevation Model

DHN Directorate of Hydrography and Navigation (Brazil)

DOC Department of Commerce (USA)

DTM Digital Topographic Model

E

F

G

GEBCO General Bathymetric Chart of the Oceans

GEODAS Geophysical Data System

GGC GEBCO Guiding Committee

GIS Geographic Information System

GMT Generic Mapping Tools

GPS Global Positioning System

H

HIPS Hydrographic Information Processing System

I

IBCAO International Bathymetric Chart of the Arctic Ocean

IHB International Hydrographic Bureau (Monaco)

IHO International Hydrographic Organization (Monaco)

IOC Intergovernmental Oceanographic Commission

J

JAMSTEC Japan Agency for Marine-Earth Science and Technology (Japan)

JODC Japan Oceanographic Data Centre (Japan)

K

km kilometer

L

LDEO Lamont-Doherty Earth Observatory

M

m meter

MBES Multi-beam echo sounder

N

NCEI National Centers for Environmental Information (USA)

NERC Natural Environment Research Council (UK)

NESDIS National Environmental Satellite, Data, and Information Service

NGDC National Geophysical Data Center (USA)

NOAA National Oceanic and Atmospheric Administration (USA)

NOC National Oceanography Centre (UK)

NRL Naval Research Laboratory

O

OGC Open Geospatial Consortium

P**Q****R**

RAS Russian Academy of Sciences (RUSSIA)

R/V Research Vessel

S

SCICEX Submarine Arctic Science Program

SHOM Service Hydrographique et Oceanographique del la Marine (France)

SOEST School of Ocean and Earth Science and Technology (USA)

SRTM Shuttle Radar Topography Mission

T

TAR Tape Archive software utility

TIN Triangular Irregular Networks

U

UNH University of New Hampshire (USA)

URL Universal Resource Locator

UTM Universal Transverse Mercator

V

W

WWW World Wide Web

X

Y

Z